

FREEDOM
Communications System Analyzer
R8200



User's Guide

Notices

© 2022 Freedom Communication Technologies

No part of this manual may be reproduced in any form or by any means (including electronic storage and retrieval or translation into a foreign language) without prior agreement and written consent from Freedom Communication Technologies as governed by United States and international copyright laws.

Acknowledgments

MOTOTRBO™ Professional Digital Two-Way Radio System

Motorola, MOTOTRBO, Private-Line, and Digital Private-Line are registered in the U.S. Patent and Trademark Office by Motorola.

NXDN™ is a trademark of Icom Incorporated and Kenwood Corporation.

All other product and service names are the property of their registered owners.

Manual Part Number

FCT-1380C

Edition

Second Edition, April 2022

Printed in USA

Freedom Communication Technologies

2002 Synergy Blvd #200

Kilgore, TX, 75662, USA

Limited Warranty

Freedom Communication Technologies Test Equipment Products (herein the "product") that are manufactured by Freedom Communication Technologies are warranted by Freedom Communication Technologies (FCT) for a period of two (2) years from date of shipment against defects in material and workmanship. This express limited warranty is extended to the original purchaser (herein the "buyer") only and applies only to such defects that: (1) produce repeatable failures resulting in product lock-ups or power downs rendering the product inoperable, or (2) cause the product to perform outside of Freedom Communication Technologies-published specifications.

In the event of such a defect during the period of warranty, the buyer may return the product, transportation prepaid, to Freedom Communication Technologies, 2002 Synergy Blvd, Suite 200, Kilgore Texas 75662. The buyer must include written notice specifying the nature of the defect, proof of purchase, and evidence of the date of shipment (dated packing list or invoice). Freedom Communication Technologies, at its option, will either repair or replace the product. If Freedom Communication Technologies elects to repair a defective product by replacing a module or subassembly, Freedom Communication Technologies, at its option, may replace such defective module or subassembly with a new or reconditioned replacement. This Limited Warranty is not extended beyond two years from original date of shipment if Freedom Communication Technologies repairs a product. Transportation charges for the return of the product will be paid by Freedom Communication Technologies.

This Limited Warranty is void if FCT determines:

- (1) The product has not been operated in accordance with the procedures in the operating instructions; or
- (2) The seals on non-user serviceable components or modules are broken; or
- (3) The product has been subject to misuse, abuse, damage, accident, negligence, attempted repair or alteration.

Freedom Communication Technologies does not warrant that the product will meet buyer's requirements or that the operation of the product will be uninterrupted or error free.

No other warranties, whether express, implied or statutory, including implied warranties or merchantability or fitness for particular purpose, are granted to buyer or buyer's transferees, customers, or users of the product.

In no event shall Freedom Communication Technologies be liable for any special, incidental, or consequential damages arising from this agreement or use of the product.

Software License Agreement

PLEASE READ THIS LICENSE AGREEMENT CAREFULLY BEFORE USING THE SOFTWARE. BY USING THE SOFTWARE, YOU AGREE TO THE TERMS OF THIS LICENSE. IF YOU DO NOT AGREE, PROMPTLY RETURN THE HARDWARE AND SOFTWARE FOR A REFUND.

1. LICENSE GRANT: As used in this Agreement, the term "Software" means the software embedded in the unit of R8200 Communications System Analyzer (the "Instrument") sold by Freedom Communication Technologies Inc. ("Licensor") to you ("Licensee") either directly or through Licensor's distribution network. Subject to your acceptance of these terms, Licensor grants to Licensee a non-exclusive license to use the Software and related documentation (the "Documentation") only in connection with your use of the unit of the Instrument in which the Software is embedded.

2. OWNERSHIP: This is not a sale of the Software. Licensor and/or its licensors retain ownership of all rights in and to the Software, including all patents, copyrights, and other intellectual property rights.

Licensee may transfer the original Software and Documentation to another entity only in connection with the sale of the unit of the Instrument in which the Software is embedded, on the condition that the transferee agrees in writing to be bound by the terms of

this agreement and Licensee provides to Licensor a copy of such agreement by the transferee.

Licensee will not reproduce, copy, decompile, disassemble, reverse engineer, modify, rent, lease, or create derivative works of the Software; transmit the Software electronically; or provide anyone with access to the Software over a network or otherwise.

Licensee will not export, re-export, resell, ship, or divert or cause to be exported, re-exported, resold, shipped, or diverted, directly or indirectly, the Software or Documentation to any country where the United States or Licensee's government or any agency thereof at the time of export or re-export requires an export license or other government approval without first obtaining such license or approval.

3. SCOPE OF USE: Licensee may use the Software only on the specific unit of the Instrument in which the Software is embedded. This license will terminate automatically if Licensee fails to comply with any term or condition of the license.

4. LIMITED WARRANTY: Licensor warrants that under normal use, the Software will perform the functions specified in the Documentation. If the Software does not conform to the Documentation, such that its functional performance is significantly impaired, and Licensee notifies Licensor in writing within ninety (90) days after the date of purchase and provides to Licensor a copy of the receipt of purchase, Licensor will have the option of refunding the purchase price or replacing the Software as Licensee's exclusive remedy.

5. LIABILITY: THE WARRANTY SET FORTH IN SECTION 4 IS EXCLUSIVE AND IN LIEU OF ALL OTHER WARRANTIES WHETHER STATUTORY, EXPRESS, OR IMPLIED (INCLUDING ALL WARRANTIES OF MERCHANTABILITY AND FITNESS FOR A PARTICULAR PURPOSE). LICENSOR WILL NOT BE LIABLE FOR INDIRECT, INCIDENTAL, SPECIAL, OR CONSEQUENTIAL DAMAGES.

6. By using the Software, Licensee acknowledges that Licensee has read this agreement and agrees to be bound by its terms and conditions. LICENSEE FURTHER AGREES THAT THIS AGREEMENT CONSTITUTES THE ENTIRE UNDERSTANDING OF LICENSEE AND LICENSOR WITH RESPECT TO THE SUBJECT MATTER HEREOF AND COMPLETELY SUPERSEDES ANY PRIOR UNDERSTANDING, EITHER ORAL OR WRITTEN. ANY MODIFICATION OF THIS AGREEMENT SHALL BE MADE ONLY BY MUTUAL AGREEMENT AND EVIDENCED BY WRITTEN AMENDMENT SIGNED BY BOTH PARTIES. This agreement shall be governed and interpreted by the laws of the State of Delaware.

7. U.S. GOVERNMENT: Licensor represents that the Software is either Commercial Computer Software as defined under DFARS 252.227-7014 (June 1995), or non-commercial computer software developed at private expense. If this license is acquired under a U.S. Government civilian agency contract, the Government's rights to use, modify, reproduce, release, perform, display, or disclose the Software are subject to restrictions set forth in FAR 52.227-19. If this license is acquired under a U.S. Government Department of Defense contract, the Government's rights to use, modify, reproduce, release, perform, display, or disclose the Software are subject to this license agreement. The License Fees identified in Exhibit A and the restrictions set forth in either FAR 52.227-19 or this license agreement do not apply to portions of the Software, if any, in which the U.S. Government has acquired Unlimited Rights.

Safety Notices

WARNING

A **WARNING** denotes a hazard. It calls attention to an operating procedure, practice, or instruction that, if not correctly performed or adhered to, could result in personal injury or death. Do not proceed beyond a **WARNING** notice until the indicated conditions are fully understood and met.

CAUTION

A **CAUTION** denotes a hazard. It calls attention to an operating procedure, practice, or instruction that, if not correctly performed or adhered to, could result in damage to the product or loss of important data. Do not proceed beyond a **CAUTION** notice until the indicated conditions are fully understood and met.

In This Guide

This user's guide refers to the R8200 Communications System Analyzer. The R8200 incorporates many devices and functions, enabling technical personnel to completely monitor and service radio communications equipment at the lab, the shop, and in the field. This guide will familiarize you with the service monitor and its design characteristics, operational modes, and system configuration.

This user's guide is organized as follows:

1 Getting Started

Explains how to unbox, set up, and initialize the analyzer. This chapter also introduces the front panel display organization and hardware features before explaining how to prepare the service monitor for safe and effective use.

2 Using Monitor Mode

Introduces Monitor Mode, the first of five operational configurations. In Monitor Mode, the instrument emulates an RF receiver focused on analyzing and displaying signals transmitted by Land Mobile Radio (LMR) equipment.

3 Using Generate Mode

Presents an overview of Generate Mode which enables the service monitor to emulate various LMR transmitters.

4 Using Duplex Mode

Explains Duplex Mode which enables the service monitor to act as a transceiver, simultaneously broadcasting and analyzing LMR signals.

5 Using Instrument Mode

Covers configuring the service monitor as a stand-alone Single-Port Vector Network Analyzer, Spectrum Analyzer, Modulation Scope, Oscilloscope, Dual Display, or Tracking Generator with a full-screen display.

6 Using Test Mode

Introduces Test Mode, the final operational configuration. This mode is used to recall preset configurations and automatically test and align specific radios. Optionally, Test Mode can analyze advance digital LMR protocols such as DMR, P25, dPMR, NXDN™ and TETRA.

7 Using Remote Front Panel

Describes how to use a Windows-based PC with the optional Remote Front Panel application to control the R8200 from a distance via network connection.

8 Monitor Mode Soft Keys

Provides essential details for all Monitor Mode soft keys including concise definitions, default settings, discrete values and ranges, and useful conceptual information.

9 Generate Mode Soft Keys

Furnishes essential details for all Generate Mode soft keys including concise definitions, default settings, discrete values and ranges, and useful conceptual information.

10 Duplex Mode Soft Keys

Offers essential details for all Duplex Mode soft keys including concise definitions, default settings, discrete values and ranges, and useful conceptual information.

11 Instrument Mode Soft Keys

Provides essential details for all Instrument Mode soft keys including concise definitions, default settings, discrete values and ranges, and useful conceptual information.

12 Test Mode Soft Keys

Outlines essential details for all Test Mode soft keys including concise definitions, default settings, discrete values and ranges, and useful conceptual information.

13 Settings Mode Soft Keys

Provides essential details for all Settings Mode soft keys including concise definitions, default settings, discrete values and ranges, and useful conceptual information.

Glossary

Offers a concise reference describing key abbreviations and acronyms.

Find the Latest Information

To maintain the highest operational fitness, Freedom Communication Technologies firmware and documentation is periodically updated. For the latest information, including firmware updates, application information, and product information, browse the following websites.

<http://freedomcte.com/upgrades/>

<http://freedomcte.com/library/>

Typeface Conventions

This guide uses the following typeface conventions to describe various aspects of the user interface.

Interface	Examples
Instrument ports, connectors, and markings	RF In/Out
Front panel hard keys and soft keys	Press Instrument > Spectrum Analyzer > Monitor Frequency to tune the receiver.
Menu, dialog, display, and data entry field names	The soft keys are available in the Marker menu.
Program messages	Is the device connected?
Data field entries	Enter 500 in the Mon Frequency dialog data entry field.
File and Folder names	Copy the file <i>IQ.txt</i> into the <i>Baseband</i> folder.

Contents

Contents	7
1 Getting Started	21
Introducing the Analyzer	22
Requirements for Safe Operation	24
Analyzer Grounding	24
Unit is Live When Plugged In or when Battery is Installed	25
Keep Away from Live Circuits	25
Explosive Atmosphere	25
WARNINGS AND CAUTIONS	25
Analyzer Operating Voltage	26
Battery	26
Compliance Information	26
Chassis Symbols and Markings	27
Port Limitations	28
Hot Surfaces	29
Mechanical Specifications	29
Maintenance of Exterior Surfaces	29
Accessories and Replaceable Parts	30
Service	30
Replacement Fuses	31
Replacement Parts Orders	31
Shipping	31

Unboxing and Inspection	32
Initial Set Up	33
Front Panel Interface	35
Display Features	40
RF Zone	41
DISPLAY Zone	42
AUDIO Zone	42
METER Zone	44
Chassis Features	45
Front Panel Ports	46
Right-Side Panel Connectors	48
Left-Side Panel Connectors	49
Configuring the Analyzer for Use	50
Operating Modes	52
2 Using Monitor Mode	53
Introducing Monitor Mode	54
RF Zone	55
DISPLAY Zone	56
AUDIO Zone	60
METER Zone	62
Measuring LMR Signals in Monitor Mode	63

3 Using Generate Mode	67
Introducing Generate Mode	68
RF Zone	68
DISPLAY Zone	69
AUDIO Zone	70
METER Zone	71
Producing LMR Signals in Generate Mode	72
4 Using Duplex Mode	75
Introducing Duplex Mode	76
RF Zone	78
DISPLAY Zone	79
AUDIO Zone	84
METER Zone	85
Verifying LMR Performance in Duplex Mode	87
5 Using Instrument Mode	92
Introducing the Spectrum Analyzer	93
Introducing the Modulation Scope	95
Introducing the Oscilloscope	96
Introducing the Dual Display	97
Introducing the Tracking Generator	98
Introducing the Cable Fault Locator	99
Introducing the Meters	100

Using the Single-Port VNA	108
Introducing the Single-Port Vector Network Analyzer	109
Display	110
Error Correction	110
Return Loss/VSWR	111
Distance To Fault	113
Normalized Impedance	115
Calibrating the VNA	116
The Device Under Test (DUT)	117
Required Equipment	117
Test Setup	118
Procedure	118
Guidelines for Recalibrating	123
Using the Calibration Kit Library	124
Selecting a Predefined Cal Kit from the Library	124
Adding a New Cal Kit to the Calibration Kit Library	126
Measuring Return Loss and VSWR	128
Required Equipment	128
Test Setup	129
Procedure	129
Measuring Normalized Impedance	135
Required Equipment	135
Test Setup	136

Procedure	136
Measuring Distance To Fault	139
Required Equipment	139
Test Setup	140
Procedure	140
Using the Cable List	144
Selecting a Cable from the Cable List	144
6 Using Test Mode	147
Introducing Presets	149
Using Presets	150
Introducing DMR Test Mode	152
The RF Zone	153
The DMR Zone	154
The DISPLAY Zone	156
The METER Zone	160
Using DMR Test Mode	163
Introducing PROJECT 25 Test Mode	168
The RF Zone	169
The PROJECT 25 Zone	170
The DISPLAY Zone	172
The METER Zone	180
Using PROJECT 25 Test Mode	183
Introducing P25 Trunk Mode	188

The RF Zone	189
The P25 Trunk Zone	191
The DISPLAY Zone	193
The METER Zone	195
Introducing NXDN™ Test Mode	196
The RF Zone	197
The NXDN™ Zone	198
The DISPLAY Zone	199
The METER Zone	201
Using NXDN™ Test Mode	203
Introducing NXDN™ Trunk Mode	208
The RF Zone	209
The NXDN™ Trunk Zone	210
The DISPLAY Zone	211
The METER Zone	213
Using NXDN™ Trunk Test Mode	215
Introducing TETRA Base Station Test Mode	220
Options and Functionality	220
Monitor Mode (Option R8-TETRA_BSM) for OTA Live Monitoring	221
Graphical Displays	225
Test Limits	227
TX Test	228
T1 Mode (Option R8-TETRA_BSM1) for OTA Monitoring and TX/RX BER	229
Channel Plan Table	231

T1 Test Display	232
Using TETRA Base Station Test Mode	236
Introducing TETRA DMO Test Mode	243
The RF Zone	244
The TETRA DMO Zone	245
The DISPLAY Zone	247
The METER Zone	251
Using TETRA DMO Test Mode	253
Introducing TETRA TMO Test Mode	258
TETRA TMO Verification Tests	258
Monitor Mode in Main Screen	259
Graphical Displays	263
Test Limits	266
Channel Plan Table	266
TX Test	268
RX Test	270
PLC Test	271
T1 Test	272
Using TETRA TMO Test Mode	273
Introducing dPMR Test Mode	278
The RF Zone	279
The dPMR Zone	280
The DISPLAY Zone	281
The METER Zone	283

Using dPMR Test Mode	285
Introducing P25 Phase 2 Mode	290
The RF Zone	291
The P25 II Zone	293
The DISPLAY Zone	294
The METER Zone	296
Introducing PTC-ITCR Mode	298
The RF Zone	299
The PTC-ITCR Zone	300
The DISPLAY Zone	302
The METER Zone	303
Using PTC-ITCR Test Mode	305
Introducing PTC-ACSES Test Mode	308
The RF Zone	309
The PTC-ACSES Zone	310
The DISPLAY Zone	311
Slot Map	312
Data Logging	315
The METER Zone	315
Using PTC-ACSES Test Mode	317
Introducing AutoTune	321
Using AutoTune	323
Introducing AutoScript	325

Commands	326
Responses	329
Field Properties	329
Local/Remote Control	334
Custom Formats	334
Field Descriptions	336
Using AutoScript	337
7 Using Remote Front Panel	341
Introducing Remote Front Panel	342
Remote Operation Requirements	343
Control	343
Remote Interface Limitations	343
Enabling the Remote Front Panel	344
Installing the Remote Front Panel Software	346
Configuring the DHCP Server	347
Configuring the Analyzer Network Port	348
Enabling Power-Loss Recovery	349
Disabling Remote Access	350
Verification / Troubleshooting Information	350
8 Monitor Mode Soft Keys	351
RF Zone Soft Keys for Monitor Mode	352
AUDIO Zone Soft Keys for Monitor Mode	356

DISPLAY Zone Soft Keys for Monitor Mode	383
METER Zone Soft Keys for Monitor Mode	401
9 Generate Mode Soft Keys	411
RF Zone Soft Keys for Generate Mode	412
AUDIO Zone Soft Keys for Generate Mode	414
DPL and DPL Invert Synthesizer Formats Soft Key	426
A/B Sequence Synthesizer Format Soft Keys	427
5/6 Tone Synthesizer Format Soft Keys	430
POCSAG Synthesizer Format Soft Keys	430
General Sequence Synthesizer Format Soft Keys	436
DISPLAY Zone Soft Keys for Generate Mode	442
METER Zone Soft Keys for Generate Mode	451
10 Duplex Mode Soft Keys	461
RF Zone Soft Keys for Duplex Mode	462
AUDIO Zone Soft Keys for Duplex Mode	468
DPL and DPL Invert Synthesizer Formats Soft Key	480
A/B Sequence Synthesizer Format Soft Keys	481
5/6 Tone Synthesizer Format Soft Keys	484
POCSAG Synthesizer Format Soft Keys	484
General Sequence Synthesizer Format Soft Keys	490
DISPLAY Zone Soft Keys for Duplex Mode	496
METER Zone Soft Keys for Duplex Mode	514

11 Instrument Mode Soft Keys	524
Spectrum Analyzer Soft Keys	525
Modulation Scope Soft Keys	535
Oscilloscope Soft Keys	539
Dual Display Soft Keys	544
Tracking Generator Soft Keys	557
Cable Fault Locator Soft Keys	567
Single-Port VNA Soft Keys	576
Calibration Soft Keys	577
Frequency Soft Keys	579
Measure Soft Keys	580
Scale Soft Keys	584
Trace Soft Keys	585
Marker Soft Keys	587
Files Soft Keys	590
12 Test Mode Soft Keys	592
Presets Soft Keys	593
Test Mode Soft Keys	595
DMR Zone Soft Keys	597
DMR Zone Soft Keys for Transmitter Test	598
DISPLAY Zone Soft Keys for DMR Transmitter Test	601
METER Zone Soft Keys for DMR Transmitter Test	607

DMR Zone Soft Keys for Receiver Test	608
PROJECT 25 Zone Soft Keys	616
PROJECT 25 Zone Soft Keys for Transmitter Test	617
DISPLAY Zone Soft Keys for PROJECT 25 Transmitter Test	620
METER Zone Soft Keys for PROJECT 25 Transmitter Test	622
PROJECT 25 Zone Soft Keys for Receiver Test	628
P25 Trunk Zone Soft Keys	639
P25 Trunk Zone Soft Keys for Transmitter Test	640
DISPLAY Zone Soft Keys for P25 Trunk for Transmitter Test	654
METER Zone Soft Keys for P25 Trunk Transmitter Test	655
NXDN™ Zone Soft Keys	656
NXDN™ Zone Soft Keys for Transmitter Test	657
DISPLAY Zone Soft Keys for NXDN™ Transmitter Test	660
METER Zone Soft Keys for NXDN™ Transmitter Test	661
NXDN™ Zone Soft Keys for Receiver Test	666
NXDN™ Trunk Zone Soft Keys	670
NXDN™ Trunk Zone Soft Keys for Transmitter Test	671
DISPLAY Zone Soft Keys for NXDN™ Trunk	678
METER Zone Soft Keys for NXDN™ Trunk Transmitter Test	679
TETRA Base Station Test Mode Soft Keys	680
TETRA Base Station T1 Mode Soft Keys	690
TETRA DMO Zone Soft Keys	696
TETRA DMO Zone Soft Keys for Transmitter Test	697

DISPLAY Zone Soft Keys for TETRA DMO Transmitter Test	698
METER Zone Soft Keys for TETRA DMO Transmitter Test	703
TETRA DMO Zone Soft Keys for Receiver Test	706
TETRA TMO Test Mode Soft Keys	708
dPMR Zone Soft Keys	730
dPMR Zone Soft Keys for Transmitter Test	731
DISPLAY Zone Soft Keys for dPMR Transmitter Test	734
METER Zone Soft Keys for dPMR Transmitter Test	736
dPMR Zone Soft Keys for Receiver Test	740
P25 II Zone Soft Keys	743
P25 II Zone Soft Keys for Transmitter Test	744
DISPLAY Zone Soft Keys for P25 Phase 2 Transmitter Test	745
METER Zone Soft Keys for P25 Phase 2 Transmitter Test	752
P25 II Zone Soft Keys for Receiver Test	756
PTC-ITCR Zone Soft Keys	759
PTC-ITCR Zone Soft Keys for Transceiver Test	760
DISPLAY Zone Soft Keys for PTC-ITCR Transceiver Test	761
METER Zone Soft Keys for PTC-ITCR Transceiver Test	762
PTC-ACSES Zone Soft Keys	764
PTC-ACSES Zone Soft Keys for Transceiver Test	765
DISPLAY Zone Soft Keys for PTC-ACSES Transceiver Test	771
METER Zone Soft Keys for PTC-ACSES Transceiver Test	772
AVIONICS Test Mode Soft Keys	774

AutoTune Soft Keys	790
AutoScript Soft Keys	799
13 Settings Mode Soft Keys	804
Settings Mode Soft Keys	805
System Settings Soft Keys	805
Network Setup Soft Keys	820

1 Getting Started

This chapter introduces the Freedom R8200 Communications System Analyzer and familiarizes you with its form, features, and functions. Review the following sections in order to ensure the safe operation of the equipment.

"Introducing the Analyzer" on the next page offers an overview of the analyzer's performance capabilities.

"Requirements for Safe Operation" on page 24 includes general safety precautions that must be observed during all phases of operation, service, and repair of this Communications System Analyzer including signal port limitations.

"Unboxing and Inspection" on page 32 offers instructions for unpacking and inspecting the R8200 Communications System Analyzer and its accessories.

"Initial Set Up" on page 33 includes steps to ensure a safe operating environment, physical stability, access to line power and battery installation.

"Front Panel Interface" on page 35 describes the organization and functions of the analyzer's front panel control interface.

"Display Features" on page 40 describes the organization and function of the analyzer's LCD screen.

"Chassis Features" on page 45 describes the locations and characteristics of the analyzer's signal ports and other hardware interface connectors along with their physical limitations.

"Configuring the Analyzer for Use" on page 50 explains how to activate and configure the instrument for use.

Introducing the Analyzer



The R8200 Communications System Analyzer is a portable test instrument designed to monitor and service LMR equipment over the frequency range of 250 kHz to 3 GHz. Firmware options provide test capability for advanced digital radio protocols such as P25 Phase 1 and 2, DMR, NXDN™, dPMR, TETRA, PTC and others. The R8200 generates and receives signals, measures return loss (VSWR), distance-to-fault, normalized impedance, power, modulation, and frequency, and performs a variety of tests normally associated with the following equipment:

- Single-Port Vector Network Analyzer
- RF Signal Generator
- Sensitive Measurement Receiver
- Spectrum Analyzer
- Duplex Offset Generator

- Oscilloscope
- Frequency Counter
- AC/DC Voltmeter
- RF Watt Meter
- Cable Fault Analyzer (optional)
- Tracking Generator (optional)
- Signaling Encoder/Decoder
- Signal Strength Meter
- SINAD Meter
- Distortion Analyzer

See **"Front Panel Interface" on page 35** for a description of the analyzer's hardware user interface, **"Display Features" on page 40** for an overview of the analyzer's LCD screen interface and, **"Chassis Features" on page 45** for a description of the analyzer's hardware connectors and ports.

Requirements for Safe Operation

The following general safety precautions must be observed during all phases of operation, service, and repair of this Communications System Analyzer. Failure to comply with these precautions or warnings violates safety standards of design, manufacture, and intended use of the equipment. Freedom Communication Technologies assumes no liability for the customer's failure to comply with these requirements.

The safety precautions and warnings listed below represent warnings of certain dangers of which Freedom Communication Technologies is aware. You should follow these warnings and all other precautions necessary for the safe operation of the equipment.

Environmental Requirements

The following table lists the environmental limitations to regard when considering appropriate areas for safe operation of the analyzer.

Environmental Factor	Limitations
Operating altitude	Up to 15,000 ft (4572 m)
Humidity	80 % maximum relative humidity
Operating temperature	-20 °C to 55 °C with external DC; 0 °C to 50 °C using supplied AC power adapter
Storage temperature	Without battery: -30 °C to +85 °C; With battery: -20 °C to +50 °C
Battery charging temperature	0 °C to +45 °C
Shock and vibration	Rated to MIL-PRF-28800F, Class 3

Analyzer Grounding

The R8200 is powered by a provided AC to DC converter connected to a grounded three-wire AC outlet. The negative (or -) output of the converter is internally connected to AC ground. Since the R8200 uses the converter's DC negative as system ground, the analyzer is also connected to AC ground at the power outlet. As a result, most of the external connectors on the R8200 chassis are also at AC ground potential.

WARNING

To minimize shock hazard, the R8200 must be operated with the provided converter and three-wire AC power cable. The power cable must be plugged into an approved three-contact electrical outlet. If the unit is not operated from a properly grounded AC power source, any voltage potential between it and earth ground may cause an electrical shock.

Unit is Live When Plugged In or when Battery is Installed

Internal circuits are live when the DC power cable is plugged in, even when the R8200 has been placed in a non-operating mode using the front panel power switch. To completely remove power from the analyzer internal circuits, disconnect the DC power plug and remove the battery. Position the equipment so that the DC power plug may be easily removed.

Keep Away from Live Circuits

Operating personnel must not remove equipment covers. Only factory and authorized service personnel may remove equipment covers for internal subassembly, component replacement, or any internal adjustment. Disconnect analyzer from all voltage sources before removing covers for adjustments, maintenance, or repairs. Capacitors inside may still be charged even if the analyzer is disconnected from the voltage source.

Explosive Atmosphere

Do not operate the equipment in the presence of flammable gases or fumes. Operation of any electrical equipment in such an environment constitutes a safety hazard.

WARNINGS AND CAUTIONS

Please observe several the following warning and precautions when configuring and operating this equipment:

WARNING

The R8200 analyzer is designed to operate with a provided AC power adapter connected to a properly grounded three-wire AC power source. This configuration provides an earth ground connection to the R8200 internal ground and chassis. If the unit is not operated with the above configuration, any voltage potential between it and earth ground may cause an electrical shock.

WARNING

DO NOT operate the R8200 analyzer using a detachable mains supply cord with an inadequate current rating. Operating the R8200 with an inadequately rated mains supply cord could result in a fire hazard. Use only an adequately rated mains supply cord equivalent to the model supplied with the AC power adapter.

CAUTION

This equipment contains internal parts that are subject to damage by static electricity (Electro-Static Discharge or ESD sensitive). Factory and authorized service personnel must follow proper ESD precautions when handling internal components during repair or calibration.

CAUTION

The AC power adapter provided with this equipment is not rated for outdoor use. Do not use this adapter outdoors, especially near water or rain.

CAUTION

This equipment contains a Rechargeable Smart Lithium Ion Battery. Only use a model RRC2020 battery in the R8200. Do not attempt to insert any other type of battery into the battery enclosure of the R8200.

Analyzer Operating Voltage

The R8200 is powered by 15–16 VDC @ 8.0 A max and operates from a three-wire AC outlet providing 100–240 VAC, 2.5 A max, 50–60 Hz, using an AC power adapter.

WARNING

Only the AC power adapter provided by Freedom Communication Technologies and shipped with the analyzer may be used to power the R8200. Do not substitute other adapters without first consulting Freedom Communication Technologies support personnel or a factory authorized service center. Make certain to plug the AC power adapter into a properly grounded three-wire AC outlet.

Battery

Rechargeable Lithium Ion (Li Ion) Battery pack, 9×18650 cells (3S3P) with 11.25 V / 8850 mAh / 99.6 Wh.





Compliance Information



The following table lists the R8200 compliance with international requirements for electromagnetic compatibility, safety, and hazardous materials standards.

Domicile	Compliance
European Directives	Electromagnetic Compatibility (EMC) EN 61326-1:2013; Low Voltage Directive EN61010-1
USA	EMC, FCC Part 15, Class A; Safety, UL 61010-1, UL61010-2-030
Canada	CSA-C22.2 No. 61010-1, CSA C22.2 No. 61010-2-030
Battery compliance	CE/ UL2054 / FCC / PSE / IEC 62133 / ROHS / UN 38.3 / RCM / EN6095

Chassis Symbols and Markings

The following table explains the markings and symbols found on the analyzer chassis.

Marking or Symbol	Explanation
Antenna	Input for optional RF antenna
Mic In	Input for external microphone with RJ-45 connector.
Demod Out	Output for the demodulated (recovered) audio output from a received carrier when the analyzer is in Monitor or Duplex Mode.
Mod In/Out	As an output, this port provides a composite sum of all internally-generated modulation signals applied to the analyzer's RF carrier. As an input, audio signals external to the analyzer can be used to modulate the RF carrier. Audio input must be $\pm 1 V_{pk}$ to provide a reference for correct display of the applied modulation level.
Meter In	Input for Oscilloscope vertical, SINAD meter, distortion meter, and DVM/-counter functions.
	WARNING To ensure the safety of the user, the Meter In port should not be used to measure equipment containing mains voltages.
RF Gen Out	Output for high level Generate RF output port isolated from the Monitor input.
	WARNING The RF In/Out connector may become hot when inputting power. Exercise caution when removing cabling from the RF In/Out connector.
RF In/Out	Input for external RF signals to the analyzer's internal monitor and output for signals from the analyzer's internal generator.
VGA Out	15-pin connector output for external VGA monitor.
USB	(2) USB 3.0 serial ports for external peripheral devices such as keyboard or flash drive.
Ethernet	RJ-45 connector for 10/100 Mbps Ethernet LAN port for a computer network interface.
Ref In/Out 10 MHz 50 Ω +10 dBm Max	Input/Output for 5 MHz or 10 MHz reference signal
DC Power  15–16 V 8A Max	Input for AC line voltage adapter
	Complies with European Economic Area health, safety, and environmental

Marking or Symbol	Explanation
	protection standards.
	Complies with Canadian and US health, safety, and environmental protection standards.
	Complies with Australian health, safety, and environmental protection standards.

Port Limitations

The following table lists the limitations and typical signals of the analyzer's input and output ports.

Port	Input Limitation or Typical Output	Notes
Antenna	0 dBm Max, 250 kHz–3 GHz (50Ω), 4.5 mA	Port Protection: 5 Watts Max
Demod Out	$\pm 8 V_{pk}$ max (600Ω), 13.3 mA	
Mod In	1 V_{pk} Ref; $\pm 1.5 V_{pk}$ Max (600Ω), 2.5 mA	
Mod Out	$\pm 8 V_{pk}$ max (100Ω), 80 mA	
Meter In	33 $V_{RMS}/70$ VDC (1MΩ) Max; 15 $V_{RMS}/24$ VDC (600Ω) Max, 40 mA	

WARNING

To ensure the safety of the user, the Meter In port should not be used to measure equipment containing mains voltages.

RF Gen Out	+5 dBm Max Out, 250 kHz to 3 GHz (50Ω)	Port Protection: 5 Watts/30 seconds Max
RF In	Absolute Max Power (250 kHz to 3 GHz) – 150 Watts (50Ω), 1.7A 50 Watts – 5 minutes ON Max/5 minutes OFF Min (0 °C to 50 °C) 150 Watts – 30 seconds ON Max/5 minutes OFF Min (25 °C to 50 °C)	

Port	Input Limitation or Typical Output	Notes
	150 Watts – 1.5 minutes ON Max/15 minutes OFF Min (0° to 25° C)	

WARNING

The RF I/O Port connector may become hot when inputting power. Exercise caution when removing cabling from the RF I/O Port. Do not apply 150 W for more than 90 seconds as temperature of RF In/Out connector can exceed 100° C.

RF Out	–30 dBm Max Out, 250 kHz – 3 GHz (50 Ohms), 0.142 mA
--------	---

Hot Surfaces

Be aware of possible changes in temperature to certain surfaces during operation.

WARNING

The RF In/Out connector may become hot when inputting power. Exercise caution when removing cabling from the RF In/Out connector.

Mechanical Specifications

Parameter	Imperial	Metric
Weight	< 14 lbs	6.4 kg
Height	9.4 in	23.9 cm
Width	12.7 in	32.3 cm
Depth	7.5 in	19.1 cm

Maintenance of Exterior Surfaces

Clean only with a damp cloth and a mild detergent. Do not use abrasives, solvents, or alcohol. If the analyzer is used in a relatively dust-free environment, no other periodic maintenance should be required.

Accessories and Replaceable Parts

This section lists the accessories shipped with the Communications System Analyzer.

Item	Part Number	Note
Connector, RT Angle BNC	BCM647	
Adapter, TNC Male to BNC Female	AC-TNCM-BNCF/A	
Adapter, N Plug to BNC jack	BCM648	
Antenna, telescoping	TSBN	
Battery pack 11.25v/8850mAH/99.6Wh Li-Ion	BATT8100	
Power cord #18AWG 1250W/10A	CCW171	AC power cord
Oscilloscope probe kit	RTL-4011A	
Microphone	VM-10042	Speaker microphone
AC/DC Level V efficiency supply with 4 pin connector	EA11011H(T14)	AC adapter
Power supply DC/DC 16V DC output	ED1010A(16)	DC adapter with cigarette lighter plug
Adapter, TNC Male to N Female	MA6532D-21	For use with VNA port
VNA Calibration Kit (Type N)	6550Y06-M	Open/Short/Standard loads
Lanyard, Astronics	Lanyard	For holding VNA Cal Kit

Send orders for accessories and user serviceable replacement parts to the Freedom Communication Technologies factory listed below. Be sure to include the complete identification number located on the equipment.

Service

All R8200 Communications System Analyzers are calibrated and repaired at the Freedom Communication Technologies factory:

FREEDOM COMMUNICATION TECHNOLOGIES

2002 Synergy Blvd. Suite 200
Kilgore, Texas, 75662, USA
Tel/Fax: 1-844-903-7333

Replacement Fuses

No user serviceable fuses are available on the R8200. The unit is internally protected against overloads and risk of fire. If the R8200 fails to operate, return it to the factory or an authorized repair center for diagnosis and repair.

Replacement Parts Orders

Send orders for user serviceable replacement parts to the Freedom Communication Technologies factory listed above. Be sure to include the complete identification number located on the equipment.

Shipping

Remove battery from unit before shipment. See the shipping requirements for your carrier.

Unboxing and Inspection

Follow these steps to unbox and inspect the analyzer and its accessories.

Steps	Actions	Notes
1. Inspect the shipping container and the packing material for signs of stress or damage.	<ul style="list-style-type: none">a. Note any damage to the shipping container.b. Open the container and inspect the packaging material for signs of stress or damage.c. Store the packing container and materials for future use if it becomes necessary to return the analyzer to the factory for servicing.	Foam pieces protect the analyzer while it is packaged inside its shipping container.
2. Inspect the contents of the shipment.	<ul style="list-style-type: none">a. Remove all packaging from the analyzer and accessories.b. Inspect each item to ensure the condition and fidelity of your order.c. Use the shipment contents list to verify the completeness of your shipment.	If the shipment is incomplete or damaged, save all of the shipping materials and contact your nearest Freedom Communications Technologies Service Center.

Initial Set Up

Follow these steps to initiate the analyzer, set your preferred language, and confirm its basic functionality:

Steps	Actions	Notes
1. Ensure a safe operational environment.	<ul style="list-style-type: none">a. Place the analyzer on a workbench in the shop or mobile repair unit, ensuring that the area is free of hazardous environmental conditions.b. Position the analyzer so that the DC power plug on the lower-left side panel may be quickly and easily removed in case of unexpected hazardous situation such as a nearby liquid spillage.c. Ensure that the fan inlet and exhaust vent areas on the sides of the analyzer are unobstructed.	
2. Ensure physical stability.	<ul style="list-style-type: none">a. Flip out the two lever actuated foot extensions underneath the front of the unit and the two underneath the rear of the unit.b. Ensure the analyzer's stability on the work surface.	
3. Access line power.	<ul style="list-style-type: none">a. Connect the appropriate end of power cord to the AC to DC adapter.b. Connect the other end of the power cord to a three-wire 100-240 VAC power source.	

Steps	Actions	Notes
	<ul style="list-style-type: none"> c. Attach the cord's DC plug to the mating connector on the R8200 side panel. 	
<ul style="list-style-type: none"> 4. Install analyzer battery. 	<ul style="list-style-type: none"> a. Remove battery from shipping box. b. Open battery access door on the lower left side of unit. c. Insert battery. d. Close and latch battery access door. 	
<ul style="list-style-type: none"> 5. Install antenna. 	<ul style="list-style-type: none"> a. Remove antenna (and other accessories) from shipping box. b. Insert the whip antenna into the ANTENNA connector, located on the right top of the chassis. 	<p>The analyzer is now ready to operate. See the following section, "Configuring the Analyzer for Use" on page 50.</p>

Front Panel Interface

The R8200 is intuitive and easy to operate. See the following table for an overview of the analyzer's front panel user interface.

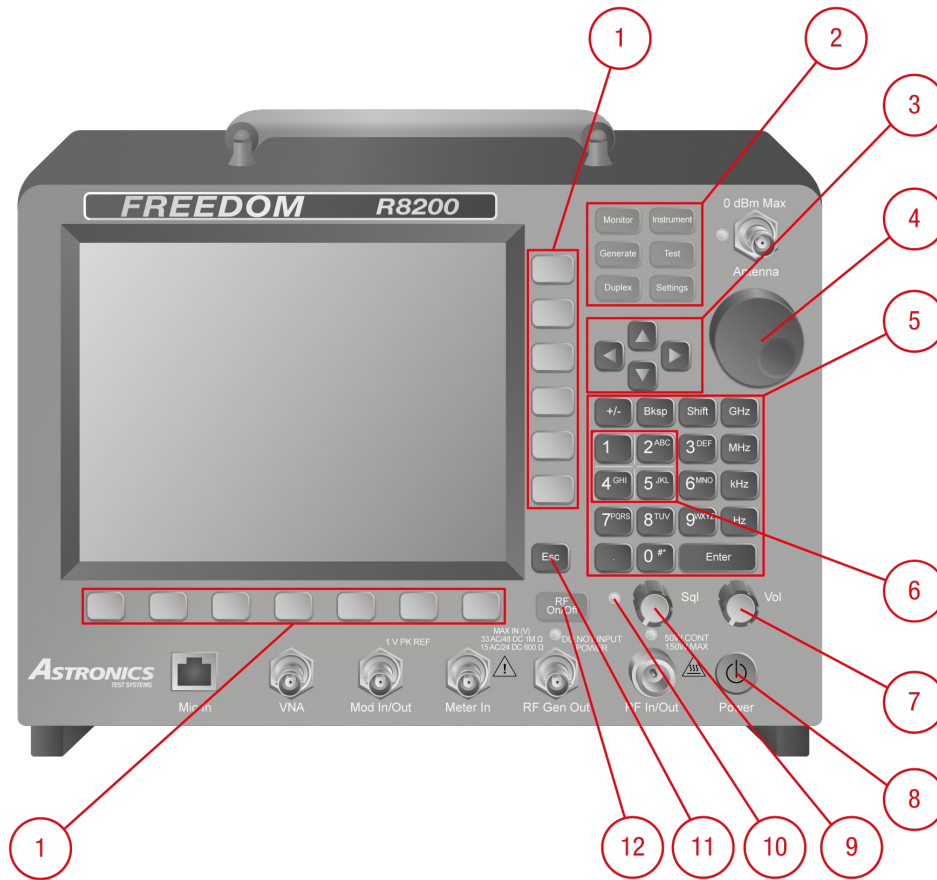

Item		Description
ID	Name	
1	Soft Keys	Two groups of mode-specific soft keys located below and beside the LCD screen. The current key function is shown in the adjacent screen area. Key functions are defined by the analyzer's current operating mode. Depending on the operating mode, pressing a soft key will either open a numeric data entry dialog, provide additional selections for configuration, activate submenus, or perform a

Item		Description
ID	Name	
		single measurement task (peak search, etc.). Multiple presses of the same key will toggle through all available selections for the setting.
2	Mode Keys	<p>Enable five primary operating modes (Monitor, Generate, Duplex, Instrument, and Test) as well as access to the analyzer's global instrument settings. The current RF operating mode is shown in the Status Bar displayed at the bottom left of the LCD screen. An adjacent area shows the current test mode (Standard or optional modes like DMR, Project 25, NXDN, dPMR, TETRA, etc.).</p> <p>Monitor enables RF receiver mode for analyzing signals between 250 kHz to 3 GHz applied to the RF In/Out or Antenna port. Monitor Mode provides signal strength, frequency accuracy, and other metering measurements while decoding the modulation content of incoming RF carriers to produce a recovered baseband signal. Additional analysis is provided by Spectrum Analyzer and Modulation Scopes.</p> <p>Generate enables the RF transmitter mode providing carrier signals with configurable output levels, modulation types (AM, FM, etc.), and tone encoding formats from 250 kHz to 3 GHz at the RF Gen Out and RF In/Out ports.</p> <p>Duplex enables simultaneous operation and independent control of the receiver (monitor) and transmitter(generate) functionality.</p> <p>Instrument enables a full-screen Single-Port Vector Network Analyzer, Spectrum Analyzer, Modulation Scope, Oscilloscope, Tracking Generator, or a dual (simultaneous) display of the Spectrum Analyzer and Modulation Scope.</p> <p>Test enables access to preset instrument configurations and optional advanced LMR test applications, as well as the AutoTune and AutoScript functionality.</p> <p>Settings enables access to global instrument settings including input decoding, reference clock mode, measurement averaging, auto-attenuation, pre-amplification, antenna, DC, and RF offsets, pre-/de-emphasis, metering filters, and audio weighting. It also enables date, time and display language, optional DMR communication protocols licensing, application and firm-ware updating, and remote operation.</p>

Item		Description
ID	Name	
3	Arrow Keys	Move the cursor in order to select and modify existing values in data entry dialogs. The horizontal arrow keys move across alphanumeric symbols in data entry dialogs to select values to enable changes via the vertical arrow keys, the tuning knob, or the alphanumeric keypad. They also step through the available selections in dialogs that display user-defined parameters. The analyzer immediately responds to changes made using the arrow keys. Pressing Enter closes the parameter adjustment dialog. Pressing Esc cancels the previous change in the manner of an Undo key. In the case of entering an RF frequency, pressing a frequency unit key (for example, kHz) also immediately alters the parameter and closes the parameter adjustment dialog.
4	Tuning Knob	Incrementally changes the value of the highlighted digit in an alphanumeric entry field. Clockwise rotation increases the value while counterclockwise rotation decreases the value. Rotating the knob immediately alters the selected parameter, providing the equivalent of an analog rotational control. For example, the operator can manually scan an RF frequency segment for an unknown carrier. The knob also cycles through the available selections when a soft key activates a parameter value dialog. The knob's press-to-enter function (pushing the knob inward until it clicks) closes the parameter value dialog, as does alternatively pressing Enter . Pressing Esc returns the value to its previous setting in the manner of an Undo key.
5	Alphanumeric Keys	Enter parameter values into the analyzer. Pressing a key during data entry places a new value into the highlighted symbol or number in a parameter value dialog or field. The analyzer immediately reacts to the new value. If an invalid entry is attempted, the key press is ignored, and the value on the screen remains unchanged. +/- toggles the directional value displayed in the currently active parameter value dialog or data entry field. Enter closes the active parameter value dialog or moves to the next field in a table.
6	Hot Keys	Numeric keys 1, 2, 4 and 5 highlighted with a gray border are navigational Hot Keys, directly activating the four functional Zones (see " Display Features " on page 40) used for measurement configuration, display, and metering. The functional Zones retain fixed arrangements on the LCD screen regardless of operating mode. These are mirrored by the same relative areas outlined around the Hot Keys. Pressing a Hot Key activates the associated Zone and displays its vertical soft key menu. Hot Keys enable navigation between Zones without navigating back to the top-level vertical soft key menu (RF, DISPLAY, AUDIO, and METER Zone soft keys).

Item		Description									
ID	Name										
7	Volume Knob	This knob controls audio volume. Clockwise rotation increases the volume. Fully counter-clockwise mutes the volume.									
8	Line Power Switch	Press to activate and deactivate the analyzer. When operating, pressing the switch for three seconds or less deactivates the analyzer with an orderly power down sequence (recommended). Pressing the switch for four seconds or more forces an abrupt shutdown (should be avoided).									
9	Sql Knob	<p>The Squelch Knob adjusts the audio gating or <i>squelch</i> function. Clockwise rotation increases the receiver signal level required to overcome the gate threshold and pass the audio signal. The fully counterclockwise position disables squelch. The Squelch Opens field in the lower right corner of the main display shows the current RF threshold level required to open the gate. The level reflects the input signal strength of the RF carrier (not the recovered audio) necessary to overcome the squelch threshold, so that measurements can be performed on un-modulated carriers. For signals below the squelch threshold, various demodulation operations cease. For example, speaker audio is muted and the Freq Error and Deviation measurements are deactivated.</p> <table border="1"> <thead> <tr> <th>Monitor Port</th> <th>Minimum Threshold</th> <th>Maximum Threshold</th> </tr> </thead> <tbody> <tr> <td>Antenna</td> <td>-130 dBm</td> <td>-20 dBm</td> </tr> <tr> <td>RF In/Out</td> <td>-100 dBm</td> <td>+10 dBm</td> </tr> </tbody> </table> <p>In Monitor Mode, the squelch threshold range is set in the RF Zone <i>Mon Port</i> field. Rotating the tuning knob will adjust the threshold in 4 dB increments.</p> <p>NOTE Additional functions utilize squelch; for examples, see "RF Scan" on page 106 and "Voice Loopback (DMR submenu)" on page 598.</p>	Monitor Port	Minimum Threshold	Maximum Threshold	Antenna	-130 dBm	-20 dBm	RF In/Out	-100 dBm	+10 dBm
Monitor Port	Minimum Threshold	Maximum Threshold									
Antenna	-130 dBm	-20 dBm									
RF In/Out	-100 dBm	+10 dBm									
10	LED Indicators	Specific port and control statuses are displayed by an adjacent LED indicator. For ports, illumination signifies the port is active and is either accepting an input or providing an output signal. This applies to the Antenna, Demod Out, Mod In/Out, Meter In, RF In/Out, and RF Gen Out									

Item		Description
ID	Name	
		ports. For controls, the LED indicator next to the Sql knob illuminates when the input signal power at the RF In/Out port is above the squelch threshold.
11	Esc Key	The Escape Key has two functions. First, it acts as an Undo Key for a previous change to a parameter value. For example, pressing Esc while entering a value with the alphanumeric keypad closes the data entry dialog and leaves the original value unchanged. Second, it acts as a Return to Top Level <i>Zone</i> Menu Key or a Return to Top Level <i>Mode</i> Menu Key. For example, if you have finished configuring the DTMF Table in the AUDIO Zone, pressing Esc once will return the display to the top-level AUDIO Zone soft keys. Pressing Esc twice will return the display to the top-level Mode soft keys (RF Zone, AUDIO Zone, DISPLAY Zone, and METER Zone).
12	RF On/Off Key	Toggles the connection between the internal RF Generator and currently configured Gen Port (generator output), either the RF In/Out or RF Gen Out port. The current RF state is displayed at the bottom right of the screen next to the message bar. It is deactivated in Monitor Mode.

Display Features

The analyzer features a large 8.4-inch LCD screen that provides operational status, measurement data, soft key-driven menus and submenus of operating controls, and instructional information. It displays in digital, analog, and bar graph forms. For most applications, the display is divided into four functional Zones (RF, DISPLAY, AUDIO, and METER) atop the Status Bar which displays from left to right: line power/battery state, current test mode, message bar, and the current operating state of the RF In/Out port. For an alternative display format see the optional TETRA Base Station and TETRA TMO user interfaces described in ["Introducing TETRA Base Station Test Mode" on page 220](#) and ["Introducing TETRA TMO Test Mode" on page 258](#), respectively.

The RF Zone is used to configure the analyzer's RF signal path. The DISPLAY Zone is used to configure the graphical display for the signal of interest. The AUDIO Zone displays parameters associated with encoding and decoding messaging content. The METER Zone displays an additional set of RF, audio, and baseband measurements.

NOTE

In Test Mode, the AUDIO Zone displays parameters associated with the current digital communications test protocol. For example, in DMR mode, this area becomes the DMR Zone.

Functional Zones are activated by pressing their associated *Hot Key* (1 for RF, 2 for DISPLAY, 4 for AUDIO, and 5 for METER) or the eponymous soft key. Once active, use the arrow keys to select values and change parameter settings.

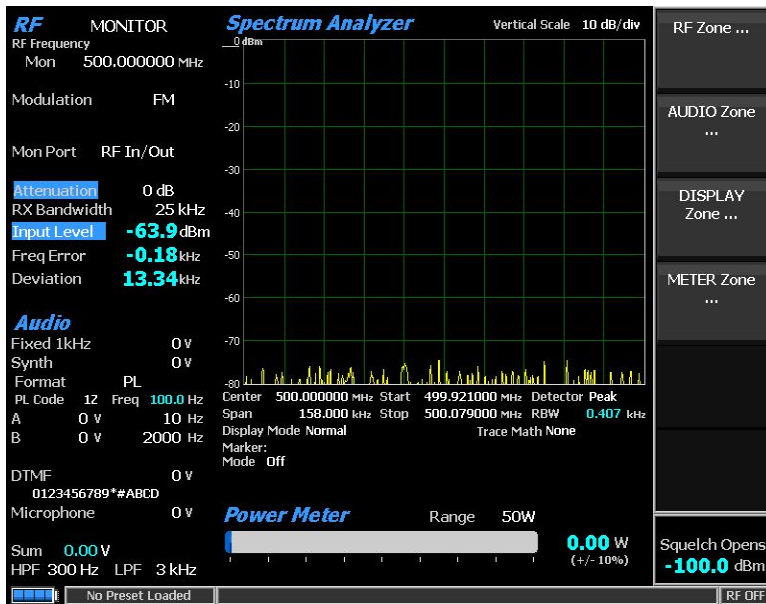

The LCD screen in the analyzer's default Monitor Mode is shown above.

The following sections explain the functional parameters associated with the RF, DISPLAY, AUDIO, and METER Zones, respectively.

RF Zone

The RF Zone occupying the upper left-hand portion of the screen is activated by pressing the top-level **RF Zone** soft key or **Hot Key 1**. The activated RF Zone is highlighted in blue, as shown below.

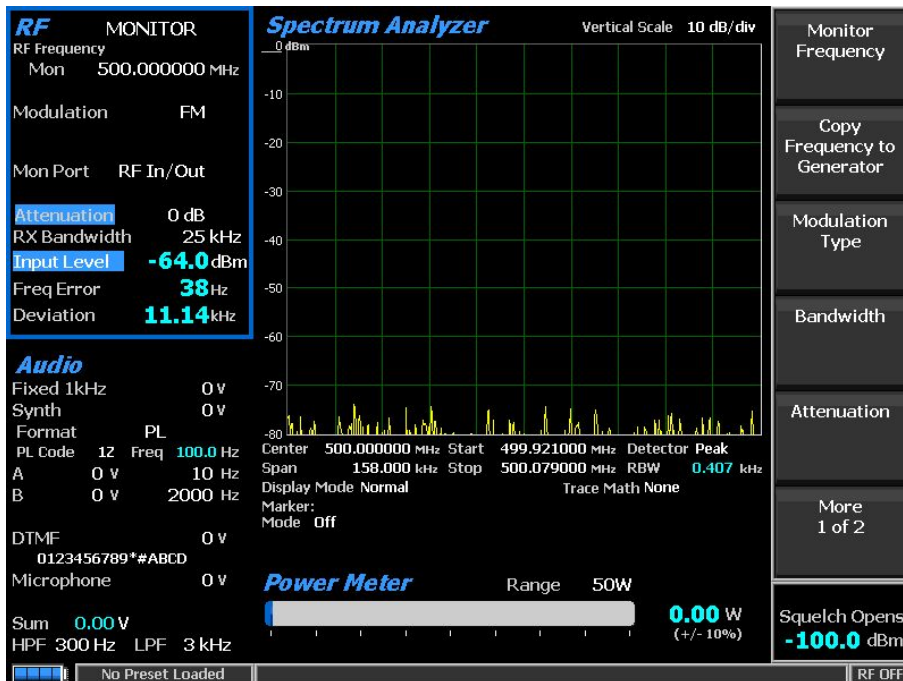

The RF Zone displays the following adjustable parameters in Monitor and Duplex Mode: Mon (receiver center frequency), Modulation (type), Mon Port (receiver input), Attenuation, Pre-amplifier, and RX (receiver) Bandwidth. It also displays three automated carrier measurements: RF Input Level, Freq Error (frequency error), and (frequency) Deviation. The RF Zone displays the following additional adjustable parameters in Generate and Duplex Mode: Gen (transmitter center frequency), Duplex Offset, (transmitter) Output Level (RF output/voltage), Output Units, and Gen Port (transmitter output).

DISPLAY Zone

The DISPLAY Zone occupying the upper right-hand portion of the screen is activated by pressing the top-level **DISPLAY Zone** soft key or **Hot Key 2** and highlighted in blue, as shown below.

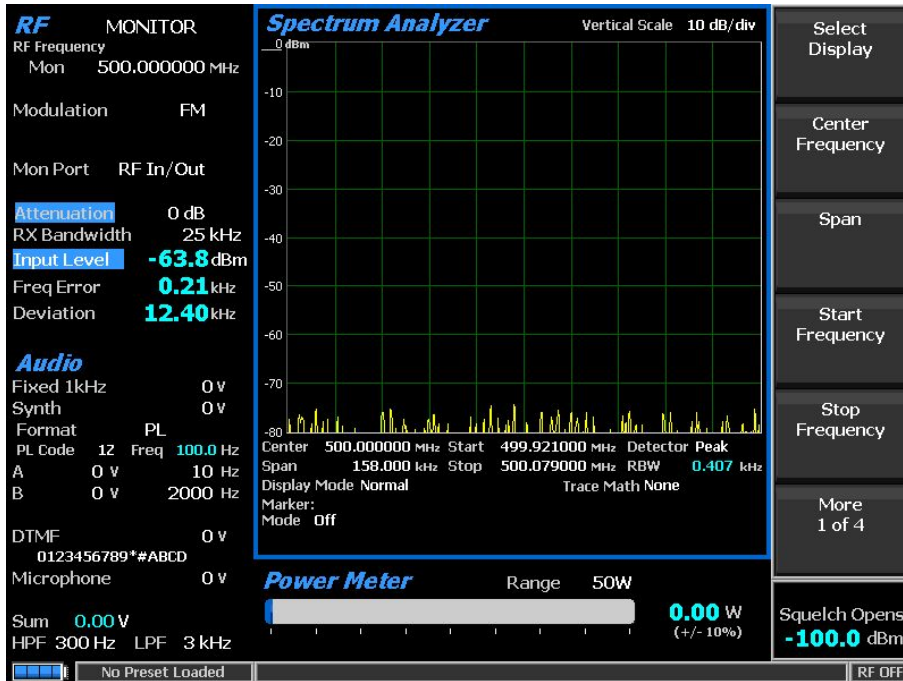

The DISPLAY Zone contains the graticule for the graphical display of the current signal of interest. The instrument type (Spectrum Analyzer, Modulation Scope, Oscilloscope, bar graphs, etc.) is shown at the top of the screen along with the vertical scale-per-division. Vertical Scale and Reference Level are shown on the Y-axis. Frequency, Marker, and Trace Math parameters are shown below the X-axis. The yellow measurement trace is displayed on the graticule.

AUDIO Zone

The AUDIO Zone occupying the lower left-hand portion of the screen is activated by pressing the top-level **AUDIO Zone** soft key or **Hot Key 4** and highlighted in blue, as shown below.

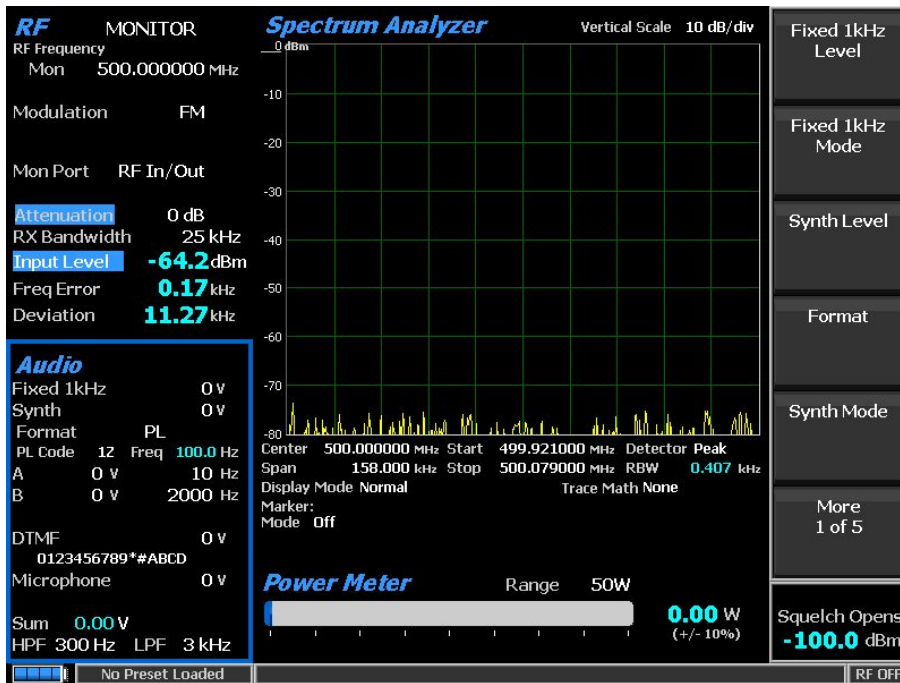

The content of the AUDIO Zone changes depending on the current mode. It contains a variety of audio settings and encoding/decoding parameters associated with the modulation of the carrier transmitted from the R8200 in Generate and Duplex Modes or the baseband filter settings for demodulation in Monitor and Duplex Modes. In Generate and Duplex Modes, the audio/modulation sources include a fixed 1 kHz tone generator, two independent variable-frequency tone (Tone A/Tone B) generators, a wide band (Tone C) generator, a dedicated dual tone multi-frequency (DTMF) generator, external inputs (microphone/modulation) and a synthesizer for generating various other encoding formats used in two-way radio performance verification testing. This synthesizer-generated composite audio modulates the internally generated RF carrier. The carrier modulation level is indicated in frequency units of deviation for FM (kHz) or amplitude percent for AM. The composite audio modulation is also available on the Mod In/Out connector. Decoding parameters for the carrier-recovered audio are primarily located in the METER Zone.

NOTE

In Test Mode, the AUDIO Zone displays parameters associated with the current digital communications test protocol. For example, in DMR mode, this area becomes the *DMR Zone*.

METER Zone

The METER Zone occupying the lower right-hand portion of the screen is activated by pressing the top-level **METER Zone** soft key or **Hot Key 5** and highlighted in blue, as shown below.

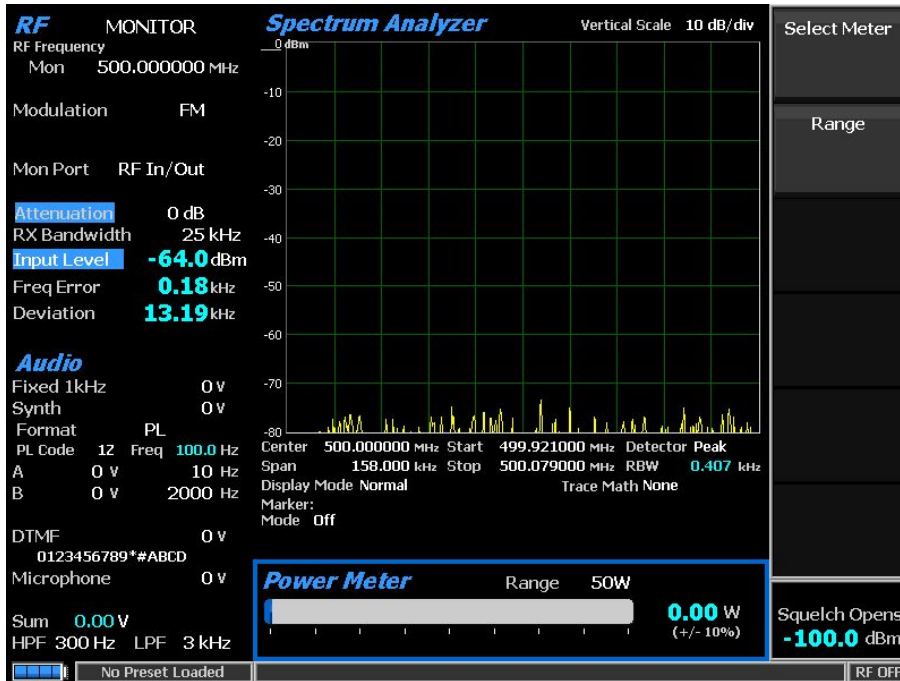

The METER Zone contains the metering display for the analyzer. The R8200 provides a Power Meter, Voltmeter, SINAD/Distortion Meter, Decoder, Frequency Counter, RF Scanner, and SNR Meter to provide detailed analysis of the RF carrier as well as the recovered baseband content. Additional meters are provided for optional digital protocol Test Modes.

Chassis Features

The analyzer can be ordered with several unique port and panel configurations. While all possible chassis configurations are described below, some may not reflect the configuration of your analyzer.

Front Panel Ports

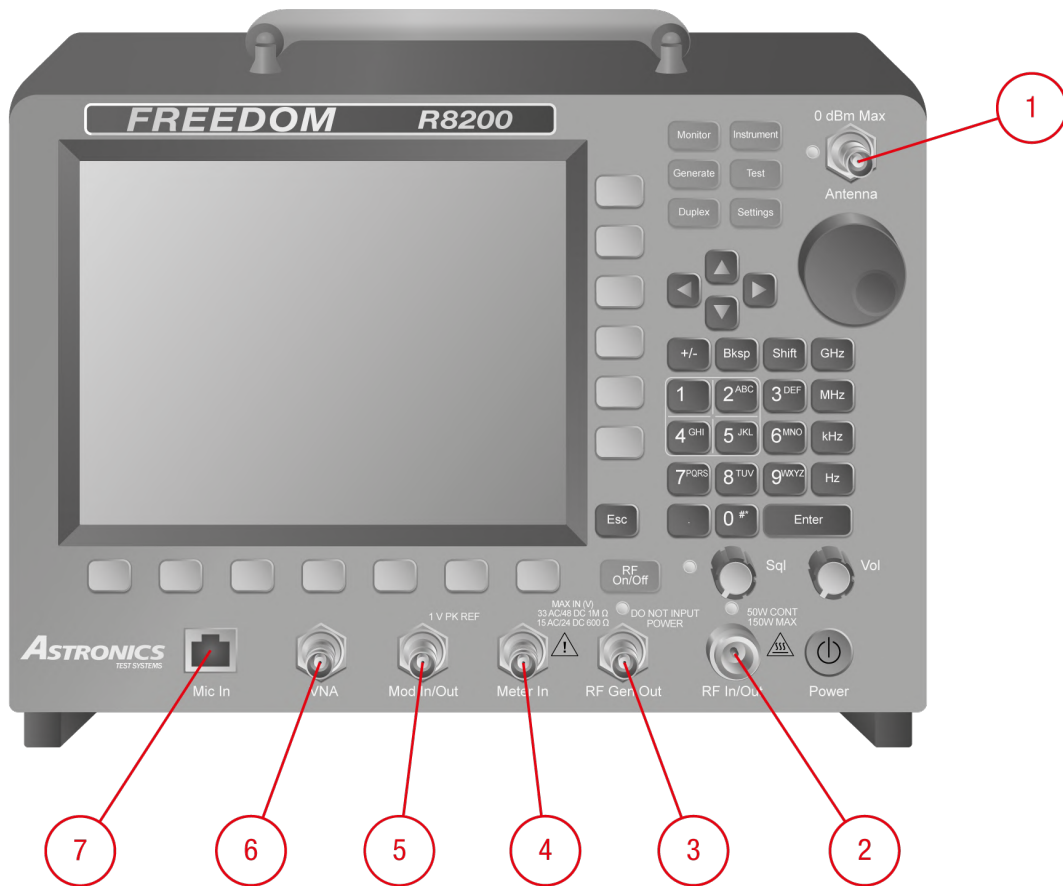

Item		Description
ID	Name	
1	Antenna	<p>BNC connector offering a low-level RF input port for the analyzer's sensitive receiver. Use for off-the-air and other low-level measurements where the RF power is less than 0 dBm.</p> <p>CAUTION Do not apply RF power \geq 0 dBm to the Antenna port.</p>
2	RF In/Out	Type N (f) connector offering a bidirectional port that routes RF input signals to the analyzer's

Item		Description
ID	Name	
		<p>internal monitor or output signals from the analyzer's internal generator. It also provides combined input/output in Duplex Mode and contains the RF Watt meter load.</p> <p>NOTE This is the only port that allows high-level RF power.</p>
3	RF Gen Out	<p>BNC(f) connector offering a high-level RF output port from the Generator which is isolated from the Monitor input.</p> <p>CAUTION Do not apply RF power to the RF Gen Out port.</p>
4	Meter In	<p>TNC(f) connector offering a combined input port for Oscilloscope vertical, SINAD meter, distortion meter, and DVM/counter functions.</p>
5	Mod In/Out	<p>BNC(f) connector, when configured as an output, this port provides a composite sum of all internally-generated modulation signals applied to the RF carrier. When set to input, external audio signals can be used to modulate the R8200 RF carrier.</p> <p>CAUTION Do not exceed +/- 1.5 V_{pk} at the Mod In/Out port or damage may occur to internal circuitry.</p> <p>NOTE The audio signals must equal +/- 1 V_{pk} to provide a reference for accurate display of the applied modulation level.</p>
6	VNA	<p>TNC(f) with Type N adapter providing single-port vector network analyses including Return Loss/VSWR and Distance To Fault.</p>
7	Mic In	<p>RJ-45 connector offering input for an external accessory microphone with RJ-45 connector.</p>

Right-Side Panel Connectors

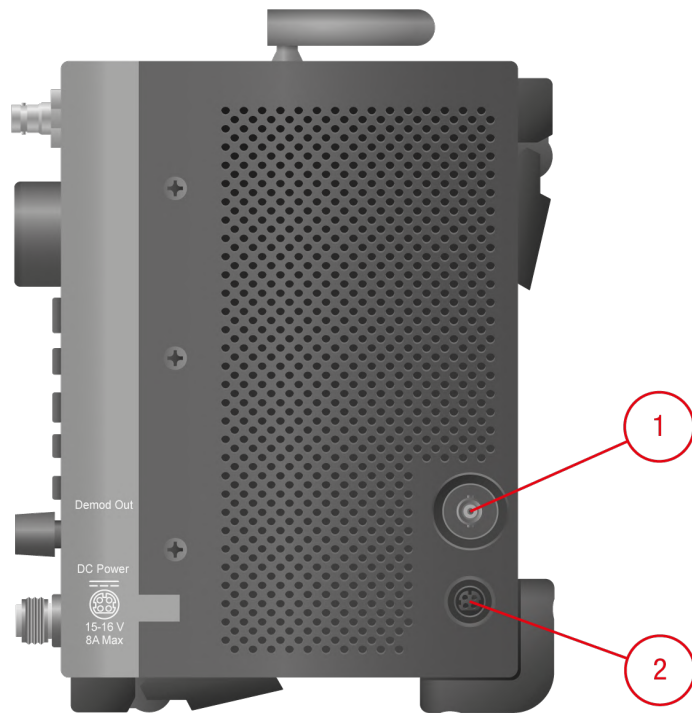

Item		Description
ID	Name	
1	Demod Out	BNC connector provides demodulated (recovered) audio output from a received carrier when the analyzer is in Monitor or Duplex Mode.
2	DC Power	Input for AC line voltage adapter

Left-Side Panel Connectors

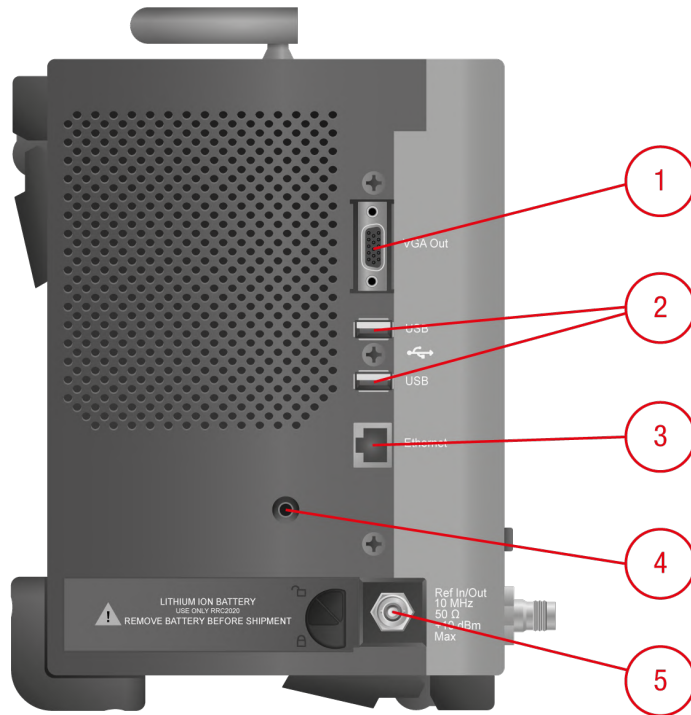

Item		Description
ID	Name	
1	VGA Out	15-pin connector for external VGA color monitor.
2	USB	Two USB 3.0 serial ports for connecting a radio under test or flash drive.
3	Ethernet	RJ-45 connector for 10/100 Mbps Ethernet LAN interface.
4	Headphone	3.5 mm stereo headphone output.
5	Ref. In/Out	BNC connector providing input/output for 10 MHz reference frequency or input for 5 MHz reference frequency. Input impedance is 50 Ω . Input level requirement is 70 mV to 1 V _{RMS} . Output level is approximately 250 mV _{RMS} .

Configuring the Analyzer for Use

This section describes how to activate the analyzer, configure global parameters such language, preset states, and remote operation. Follow these steps to initiate the analyzer, set your preferred language, and confirm its basic functionality.

Steps	Actions	Notes
1. Activate the analyzer.	a. Press the green circular power switch in the lower right-hand corner of the front panel.	It takes less than 90 seconds for the analyzer to boot up.
2. Set the preferred language.	a. Press Settings > System Settings > More × 4 > Language . b. Choose English or Spanish .	This opens a horizontal soft key menu where you can select your preferred language.
3. Set the date.	a. Press Date . b. Use the arrow keys, tuning knob, or the alphanumeric keypad to enter the values for the current month, day and year. c. Press Enter .	The date is formatted as mm.dd.yyyy. You can use the horizontal arrow keys to move between values.
4. Set the time.	a. Press Time . b. Use the vertical arrow keys, tuning knob, or the alphanumeric keypad to enter the values for the hour and minute. c. Press More > Apply Date/Time Changes .	The time is in 24-hour format.
5. Prepare to make your initial RF measurements.	a. Connect your device to the analyzer. b. Configure the analyzer to perform the desired analysis.	The analyzer can be used immediately after boot up with best accuracy achieved after a suitable warm-up period. The OCXO time base stabilizes within five minutes

Steps	Actions	Notes
	c. Complete the measurement.	of operation, permitting frequency-dependent measurements at the specified accuracy of the analyzer (e.g., operating frequency, frequency error, audio tone generation, etc.). For all other measurements, a minimum warm-up of 15 minutes is recommended, with full measurement stability after 30.
6. Otherwise, power down the analyzer.	a. Quickly press the front panel switch to turn the analyzer off.	When operating, pressing the switch for three seconds or less turns off the analyzer with an orderly power down sequence (recommended). Pressing the switch for four seconds or more forces an abrupt shutdown (should be avoided).

Operating Modes

The R8200 has six unique operating modes:

- **Monitor** – for analyzing the transmitter performance of LMR mobile and portable radios. In Monitor Mode, the R8200 emulates a series of instruments traditionally used to measure various aspects of microwave, RF, and audio signals such as Vector Network Analyzers, Spectrum Analyzers, Modulation Scopes, Oscilloscopes, and Tracking Generators.
- **Generate** – for producing precision microwave, RF, and audio signals necessary to evaluate LMR mobile and portable radios' receiver performance. In Generate Mode, analyzer emulates a series of signal generators such as microwave and RF signal sources, function generators, and synthesized sweepers.
- **Duplex** – which combines Generate and Monitor functionality to simultaneously stimulate and measure the performance of LMR mobile and portable radio transceivers.
- **Instrument** – for analyzing a particular aspect or component of LMR mobile and portable radio transmitters. In Instrument Mode, the R8200 emulates a stand-alone, full-screen Vector Network Analyzer, Spectrum Analyzer, Modulation Scope, Dual Display (Spectrum Analyzer with Modulation Scope), Oscilloscope, Tracking Generator, or Cable Fault Locator.
- **Test** – for simultaneous broadcast and measurement of signals defined by advanced digital radio protocols such as P25 Phase 1 and 2, DMR, NXDN™, dPMR, TETRA, PTC and others employed by the world's largest LMR mobile, portable, and infrastructure manufacturers.
- **Settings** – for managing the global operational parameters of the R8200.

Together, these six unique operating modes make the R8200 an indispensable tool for the ongoing care and maintenance of your valuable LMR assets.

Turn to **"2 Using Monitor Mode" on page 53** for step-by-step instructions on using the R8200 to analyze the transmitter performance of an LMR mobile or portable radio.

2 Using Monitor Mode

This chapter explains how to use the analyzer as a stand-alone monitor or RF receiver for testing LMR transmitters or other RF signal sources. It includes an overview of the use model and display features with links to the detailed soft key reference and an example measurement configuration.

See **"Introducing Monitor Mode" on the next page** for an introduction to using the R8200 in Monitor Mode to measure the output of LMR transmitters or other RF signal sources.

See **"Measuring LMR Signals in Monitor Mode" on page 63** for step-by-step instructions on configuring the R8200, connecting the radio to the R8200, and configuring the radio to make an initial carrier power and frequency analysis of the unit under test.

Introducing Monitor Mode

In Monitor Mode, the analyzer operates as a stand-alone RF receiver for testing radio transmitters. It is capable of monitoring either over the air (OTA) RF signals through its ANTENNA port or a direct connection to the transmitter through the RF In/Out port. The operating frequency range is 250 kHz to 3 GHz in 1 Hz increments with selectable bandwidths between 6.25 kHz and 200 kHz.

The analyzer processes AM and FM carriers and a variety of audio encoding formats. It provides signal strength, frequency accuracy, and other metering results while decoding the messages on incoming RF carriers to produce a recovered baseband signal. Additional analysis is provided by a Spectrum Analyzer and a Modulation Scope. When activated by pressing the blue Monitor operating mode key, the Monitor Mode is displayed as shown.

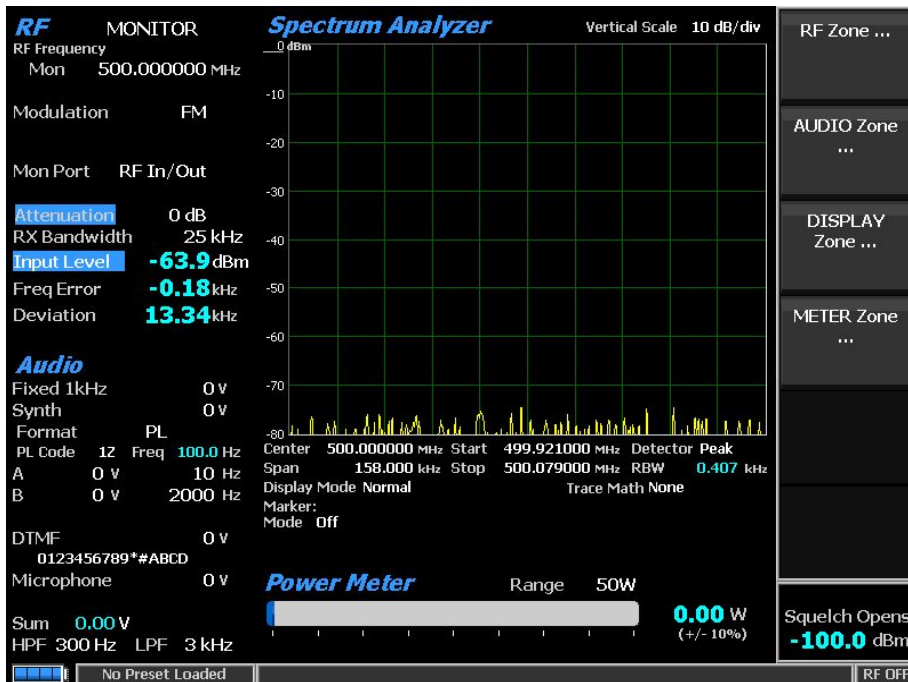

The following sections explain the functional parameters associated with the RF, DISPLAY, AUDIO, and METER Zones, respectively.

RF Zone

The RF Zone in the upper left-hand screen is activated by pressing the top-level **RF Zone** soft key or **Hot Key 1**. The active RF Zone is bordered in blue, as shown.

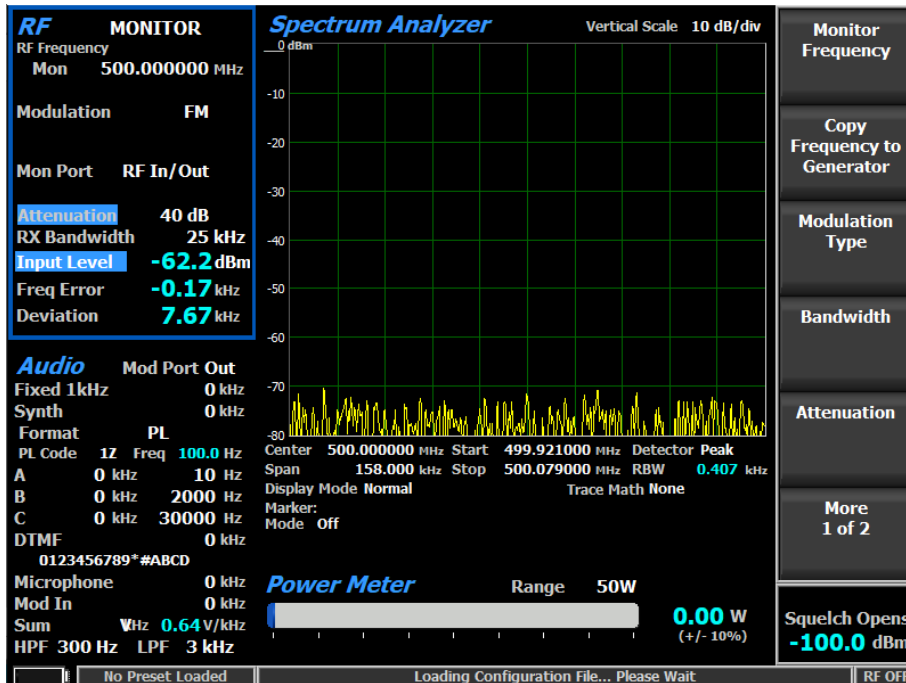

The RF Zone displays the following adjustable parameters: Mon (receiver center frequency), Modulation (type), Mon Port (receiver input), Input Source, Input Units, Attenuation, Pre-Amplifier. and RX (receiver) Bandwidth. It also displays three fields of automated carrier measurements: Input Level, Freq Error (frequency error), and (frequency) Deviation.

NOTE

When the RF input power on the RF In/Out port is above +20 dBm (100 mW), the R8200 utilizes a broadband power detector for the measurement. The Input Level field in the RF Zone changes to Watt Meter to indicate broadband power measurement.

Input Level – Displays the RF input level of the received carrier. Different units may be selected using the Input Level Units soft key.

Watt Meter – Displays the level of broadband power applied to the RF In/Out port. For increased Watt Meter accuracy, disable the Pre-amplifier in Monitor Mode (press **Settings** > **System Settings** > **More** × 2 > **Pre-Amplifier Auto Off** > **Enable**), and in Generate Mode, set the Gen Port to RF In/Out (press **Generate** > **Gen Port** > **RF In/Out**).

Freq Error – Displays the frequency difference between the received carrier frequency and the R8200 current Monitor Center Frequency.

Deviation – When the selected modulation type is FM, displays the positive peak frequency deviation of the received modulated carrier (i.e., from the Frequency Error mean). Negative peak frequency deviation can be observed by selecting Bar Graphs in the DISPLAY Zone (press **DISPLAY Zone** > **Select Display** > **Bar Graphs**).

%AM – When AM modulation is selected, displays the positive peak AM percentage of the received modulated carrier.

For RF Zone soft key definitions, ranges, discrete and default values, and detailed notes, see "[RF Zone Soft Keys for Monitor Mode](#)" on page 352.

DISPLAY Zone

The DISPLAY Zone in the upper right-hand screen is activated by pressing the top-level **DISPLAY Zone** soft key or **Hot Key 2**. The active DISPLAY Zone is bordered in blue, as shown.

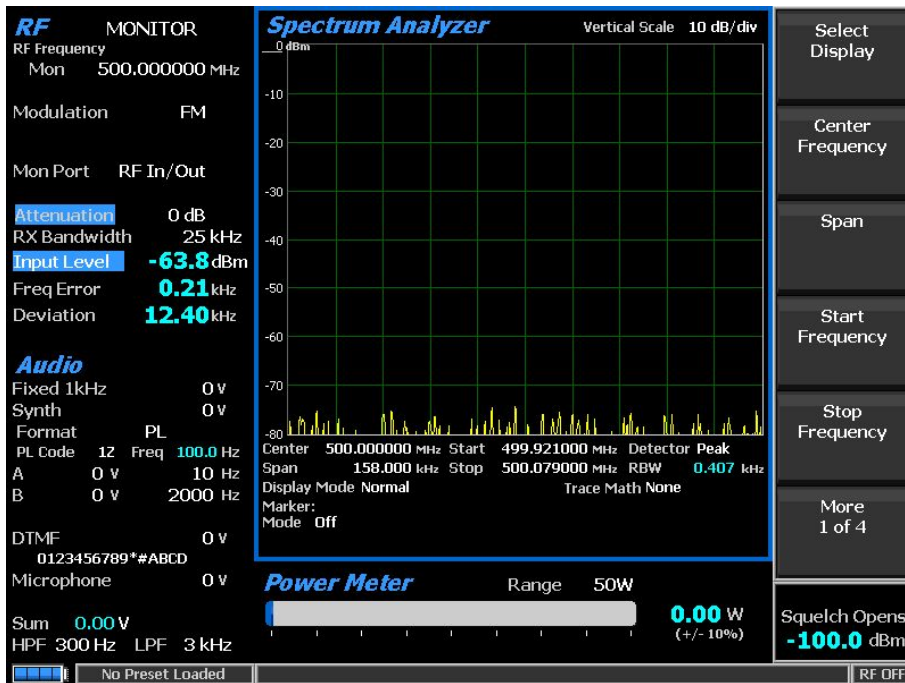

The DISPLAY Zone contains the graticule for the graphical display of the current signal of interest providing a visual presentation of received RF signal measurements, recovered audio, internally-generated audio, and externally-measured audio signals. These include a Spectrum Analyzer, Modulation Scope, Oscilloscope, and Bar Graphs. The instrument type is shown at the top of the screen along with the vertical scale-per-division. Vertical scale and reference level are shown on the Y-axis. Frequency, Marker, and Trace Math parameters are shown below the X-axis. The yellow measurement trace is displayed on the graticule.

For bar graph displays, see ["Bar Graphs" on the next page](#). For General Sequence display, see ["Introducing Monitor Mode" on page 54](#).

For details regarding the individual instrument displays, see:

- ["Introducing the Spectrum Analyzer" on page 93](#)
- ["Introducing the Modulation Scope" on page 95](#)
- ["Introducing the Oscilloscope" on page 96](#)

Bar Graphs

The Bar Graphs display provides a simultaneous analog and digital readout of critical signal characteristics. The analog display facilitates real time tuning adjustments of two-way radios while the digital reading provides precision in the measured result. The Monitor Deviation response can be changed to peak averaging, power-weight averaging, RMS averaging, or +/-Peak/2. Three bar graphs are displayed for the received carrier while in Monitor and Duplex Modes, as shown here when FM is selected as the Modulation Type.

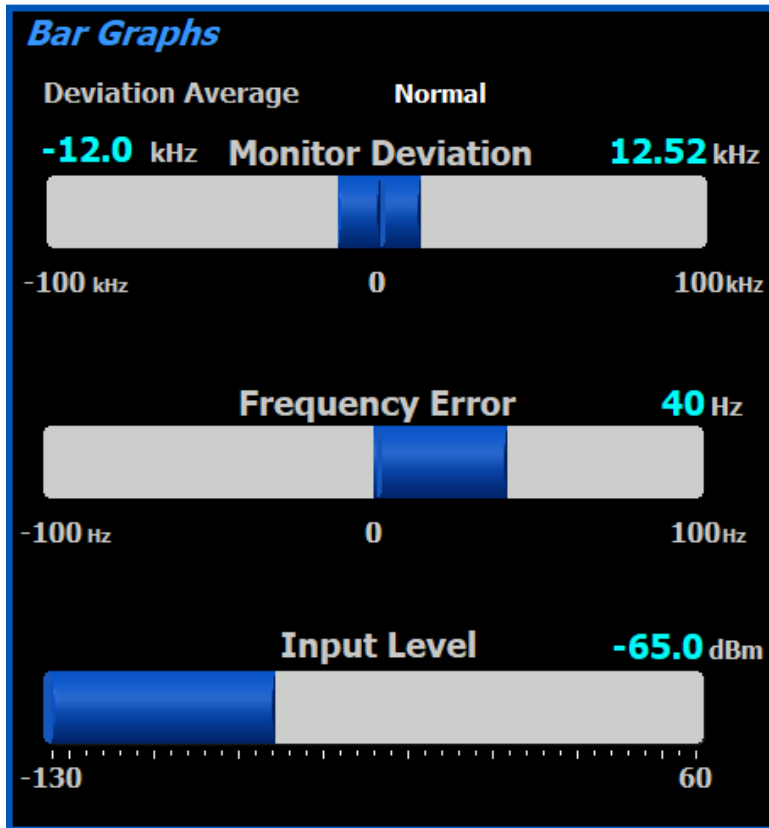

Monitor Deviation

This graph displays the negative and positive peak frequency deviation of a modulated carrier (i.e., from the Frequency Error mean), available when Modulation Mode is FM.

Monitor AM%

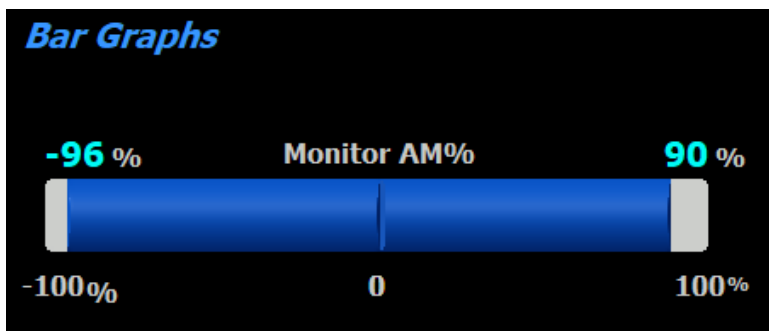

When Modulation mode is AM, this graph displays the negative and positive peak AM percentages of a modulated carrier.

Frequency Error

Represents the frequency difference (error) of the input carrier minus the current center frequency setting of the receiver (i.e., Monitor Frequency).

Input Level

Displays the RF input level of the carrier. Indicated units are Volts, Watts, or dBm as defined by the Input Level Units parameter in the RF Zone.

NOTE

When the RF input power on the RF In/Out port is above +20 dBm (100 mW), the R8200 utilizes a broadband power detector for the measurement. The Input Level field in the RF Zone changes to Watt Meter to indicate this measurement mode.

The Input Source parameter can be used to force narrow or broadband power. That is useful for TDMA protocols whose on and off slots can cause the indicator to toggle between them.

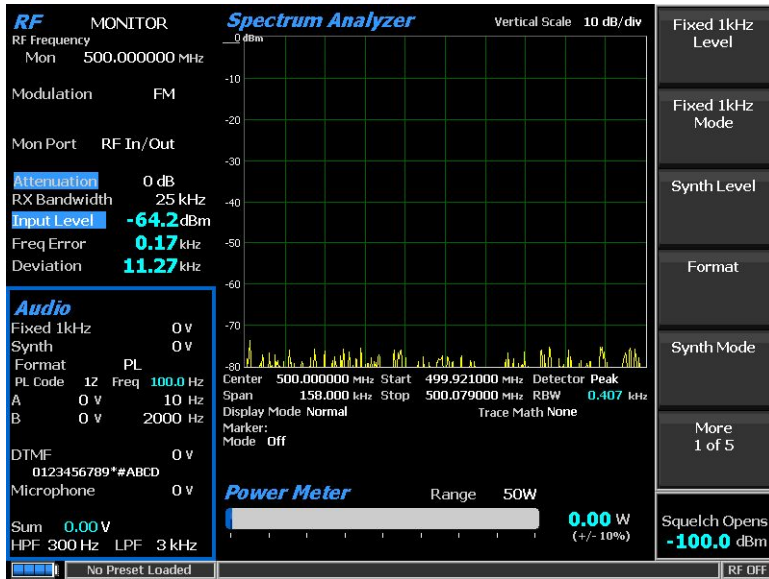

In Monitor Mode, the AUDIO Zone contains audio and baseband filter settings for retrieving test signals and a display of the current encoding format and voltage level.

NOTE

AUDIO Zone menu screens display common settings along with menu choices that change to reflect the Format (signal type) chosen for the audio synthesizer. Different submenu screens and settings appear when other encoding types such as DPL, A/B Sequence, or 5/6 Tone are selected with the Format soft key.

The audio synthesizers operate like a stand-alone audio generator since they are not modulating a carrier. The composite audio signal is available at the Mod In/Out port.

Sum – displays the composite sum of all audio sources enabled in volts.

NOTE

Decoding parameters for the carrier-recovered audio are primarily located in the METER Zone.

For AUDIO Zone soft key definitions, ranges, discrete and default values, and detailed notes, see "**AUDIO Zone Soft Keys for Monitor Mode**" on page 356.

METER Zone

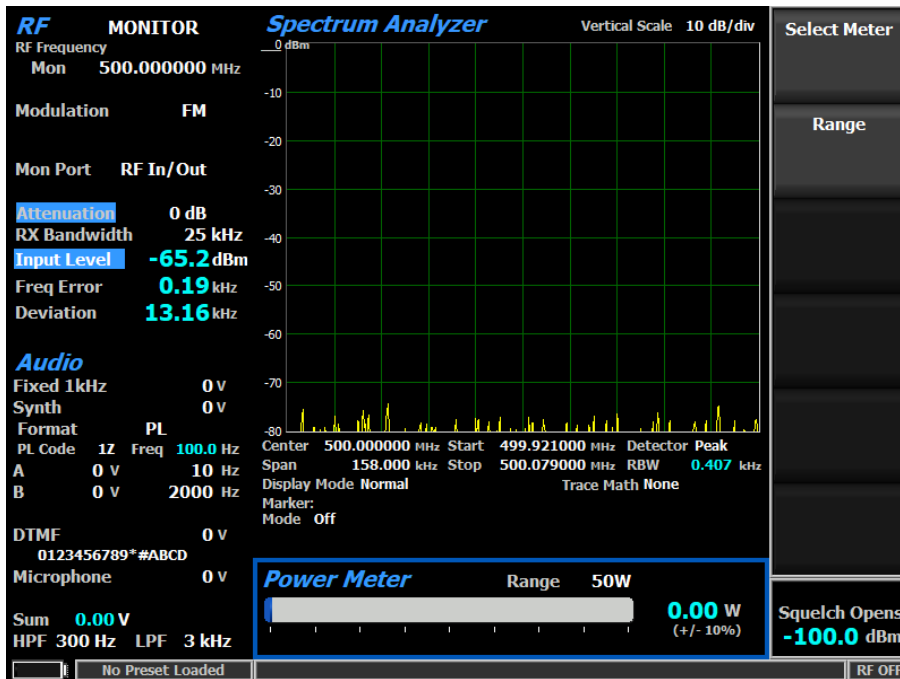

The METER Zone in the lower right-hand screen is activated by pressing the top-level **METER Zone** soft key or **Hot Key 5**. It contains the metering display for the receiver, represented in a dedicated area on the LCD screen below the DISPLAY Zone. The R8200 offers a Power Meter, Voltmeter, SINAD/Distortion, Decoder, Frequency Counter, RF Scan, and SNR meter to provide detailed analysis of the RF carrier as well as the recovered baseband content. For individual meter descriptions, see **"Introducing the Meters" on page 100**.

For METER Zone soft key definitions, ranges, discrete and default values, and detailed notes, see **"METER Zone Soft Keys for Monitor Mode" on page 401**.

See the following section, **"Measuring LMR Signals in Monitor Mode" on the next page** for instructions on configuring a simple FM transmitter test using Monitor Mode.

Measuring LMR Signals in Monitor Mode

This section provides an example verification measurement of a portable radio's digital signal processing without the need for specialized power supplies, test boxes, or radio service software. It can be completed using only the radio, a single BNC cable, and two adapters. This section describes a simple procedure for verifying the basic functionality of the radio's RF transmitter and physical layer protocol using the R8200 in Monitor Mode. Follow these steps to connect the radio to the R8200 and configure your measurement.

Required Equipment

- Freedom R8200 Communications System Analyzer
- Portable Radio, programmed for Project 25 (i.e., Motorola APX 6000 or similar)
- Cable, coax, BNC (m-m)
- Adapter, Type N(f)-to-BNC(f)
- Adapter, SMA(f)-to-BNC(f)

Video Support

A video of this transmitter verification procedure is available on the Freedom Communication Technologies YouTube channel at <https://youtu.be/tJsQkOedFQU>.

Test Setup

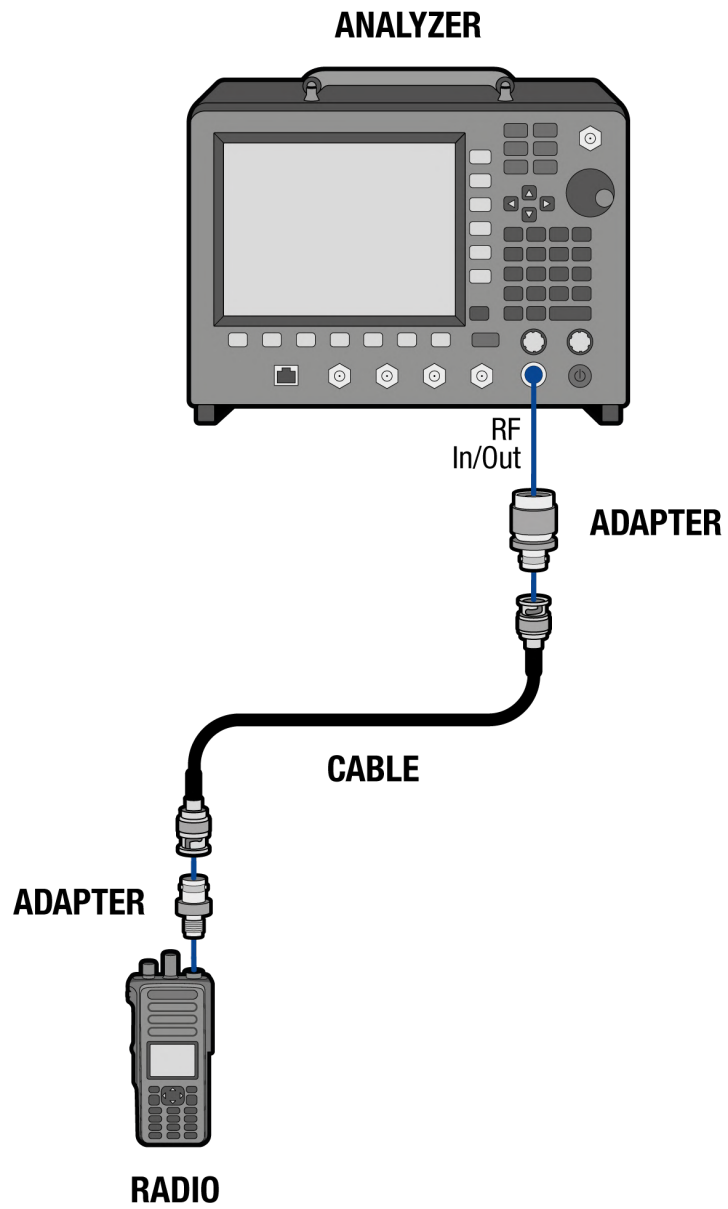

Procedure

Steps	Actions	Notes
1. Configure the test setup.	<ul style="list-style-type: none"> a. Connect the Type N(f)-to-BNC(f) adapter to the R8200's RF In/Out port. b. Remove the antenna from the radio. c. Connect the SMA(f)-to-BNC(f) Adapter to the Antenna port of the radio. d. Connect the BNC cable between the radio and the R8200. 	
2. Configure the R8200.	<ul style="list-style-type: none"> a. To access the PROJECT 25 Test Mode, press Test > Test Mode > PROJECT 25. b. To set the receiver Center Frequency to match the radio transmitter, press Hot Key 1 > Monitor Frequency > 851 > MHz. c. In the RF Zone, confirm that Mon Port displays RF In/Out as the receiver's input. d. To appropriately attenuate the receiver's input, press Attenuation > 40 dB. 	<p>This opens the PROJECT 25 Test menu.</p> <p>Alternatively, press RF Zone > Monitor Frequency > 851 > MHz.</p> <p>If not, press Mon Port > RF In/Out > Enter.</p>
3. Activate and key the radio.	<ul style="list-style-type: none"> a. Turn the On/Off/Volume Knob clockwise to activate the radio. b. Press PTT on the portable. 	This initiates a broadcast of the voice content picked up by the radio microphone.
4. Observe the DISPLAY Zone.	<ul style="list-style-type: none"> a. Confirm that the analyzer is 	You should observe change in the

Steps	Actions	Notes
	decoding the radio's transmitted Voice Frame Data.	Voice Frame Data display.
5. Observe the RF Zone.	<p>a. Confirm that the Input Level displays the radio's output as approximately 3 W.</p> <p>b. Confirm that the Freq Error displays the radio's frequency error as less than 100 Hz.</p>	This verifies the performance of the radio's RF transmitter.
6. Observe the PROJECT 25 Zone.	<p>a. Confirm that NAC displays a valid Network Access Code.</p> <p>b. Confirm that Mod Fidelity displays less than 1%.</p> <p>c. Confirm that Symbol Dev displays less than 2 kHz.</p>	This verifies that the radio correctly encoding the PROJECT 25 message content.

Having confirmed these transmission parameters, you can verify that the transmitter on this radio is working properly in PROJECT 25 Test Mode.

3 Using Generate Mode

This chapter explains how to use the analyzer as a stand-alone RF signal source or RF transmitter for testing LMR receivers. It includes an overview of the use model and display features with links to the detailed soft key reference and an example LMR broadcast configuration.

See **"Introducing Generate Mode" on the next page** for an overview of the Generate Mode display and use model.

See **"Producing LMR Signals in Generate Mode" on page 72** for step-by-step instructions on configuring the R8200, connecting the radio, and configuring the radio to make an initial carrier power and frequency analysis of the radio's receiver.

Introducing Generate Mode

In Generate Mode, the analyzer operates as an RF transmitter for testing radio receivers over an operating frequency range of 250 kHz to 3 GHz in 1 Hz increments. The RF carrier output is accessible through the RF Gen Out or RF In/Out ports for over the air (OTA) operation or direct coupling to a receiver. The output level is adjustable from -95 dBm to +5 dBm (Standard) or -125 dBm to +5 dBm (Optional) on the RF Gen Out port, and -130 dBm to -30 dBm on the RF In/Out port. A variety of modulation types and encoding formats are available for the RF carrier.

The following sections explain the unique functional parameters associated with the RF, Display, Audio and METER Zones respectively while in Generate Mode.

RF Zone

When the RF Zone is selected while in Generate Mode, the R8200 display appears as shown.

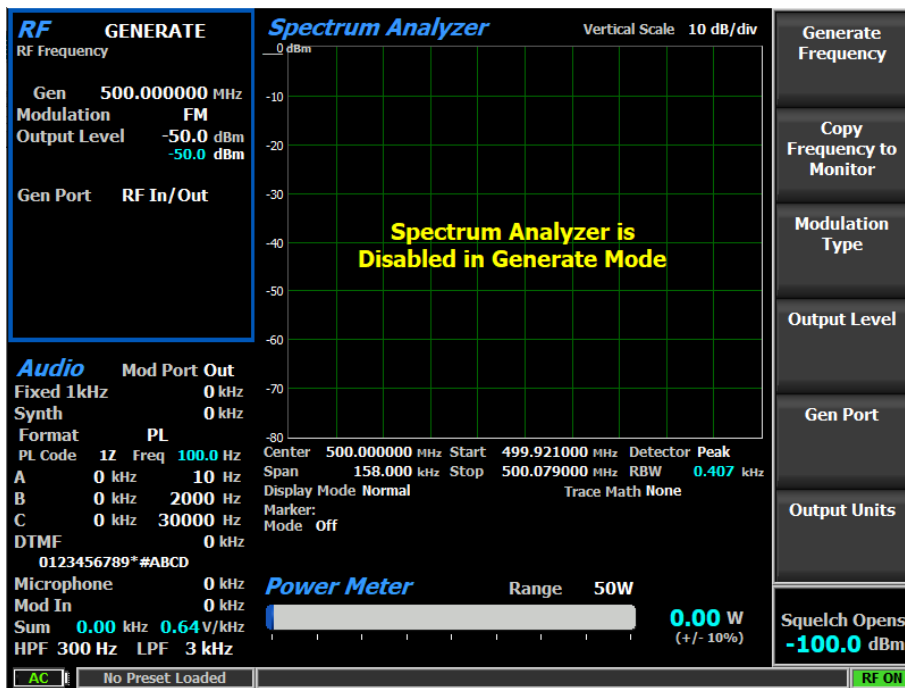

In Generate Mode, the RF Zone displays the following adjustable parameters: Gen (transmitter center frequency), Duplex Offset, Modulation (type), Output Level (RF output power/voltage), Output Units, and Gen Port (transmitter output).

For RF Zone soft key definitions, ranges, discrete and default values, and detailed notes, see ["RF Zone Soft Keys for Generate Mode"](#) on page 412.

DISPLAY Zone

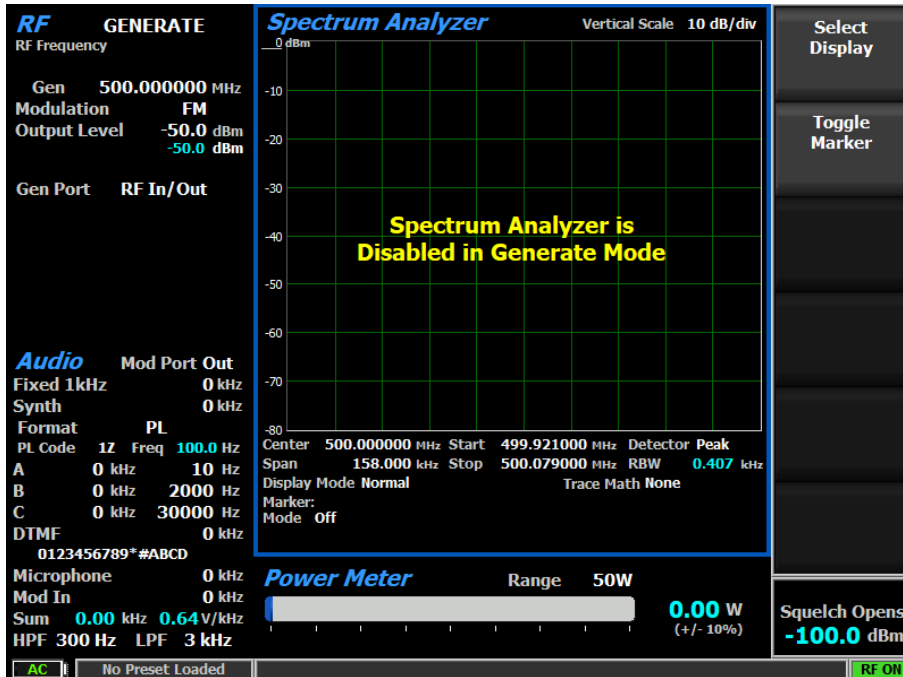

In Generate Mode, the DISPLAY Zone in the upper right-hand screen is activated by pressing the top-level **DISPLAY Zone** soft key or **Hot Key 2**. It contains the graticule for the graphical display of the current time-based signal of interest (frequency based instrument displays such as Spectrum Analyzer and bar graphs are disabled). The instrument type (Modulation Scope or Oscilloscope) is shown at the top of the screen along with the vertical and horizontal scale-per-division. When Oscilloscope is selected, Maximum Recommended Input frequency is also displayed at the top of the screen. Vertical scale in voltage/div is shown on the Y-axis. Horizontal scale in time/div is shown on the X-axis. The yellow measurement trace is displayed on the graticule.

For DISPLAY Zone soft key definitions, ranges, discrete and default values, and detailed notes, see ["DISPLAY Zone Soft Keys for Generate Mode"](#) on page 442.

AUDIO Zone

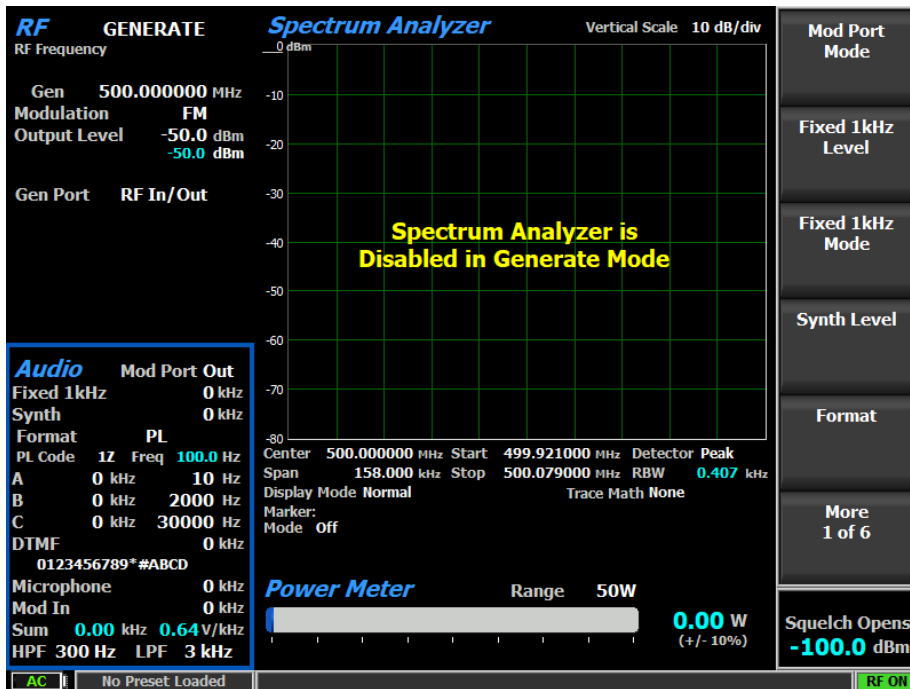

The AUDIO Zone in the lower left-hand screen is activated by pressing the top-level **AUDIO Zone** soft key or **Hot Key 4**. It contains audio and baseband filter settings for encoding test signals and a display of the current encoding format and voltage level.

The AUDIO Zone parameters in Generate Mode replicate those in Monitor Mode *with two key differences*.

- In Generate Mode, the audio signal is applied simultaneously, as modulation to the RF carrier, and as a base band signal at the Mod In/Out connector.
- In Generate Mode, (Mod) Sum level is shown in units of FM deviation (kHz) or AM modulation depth (%), depending on the current Modulation Type (FM or AM, respectively) displayed in the RF Zone.

For AUDIO Zone soft key definitions, ranges, discrete and default values, and detailed notes, see "**AUDIO Zone Soft Keys for Generate Mode**" on page 414.

METER Zone

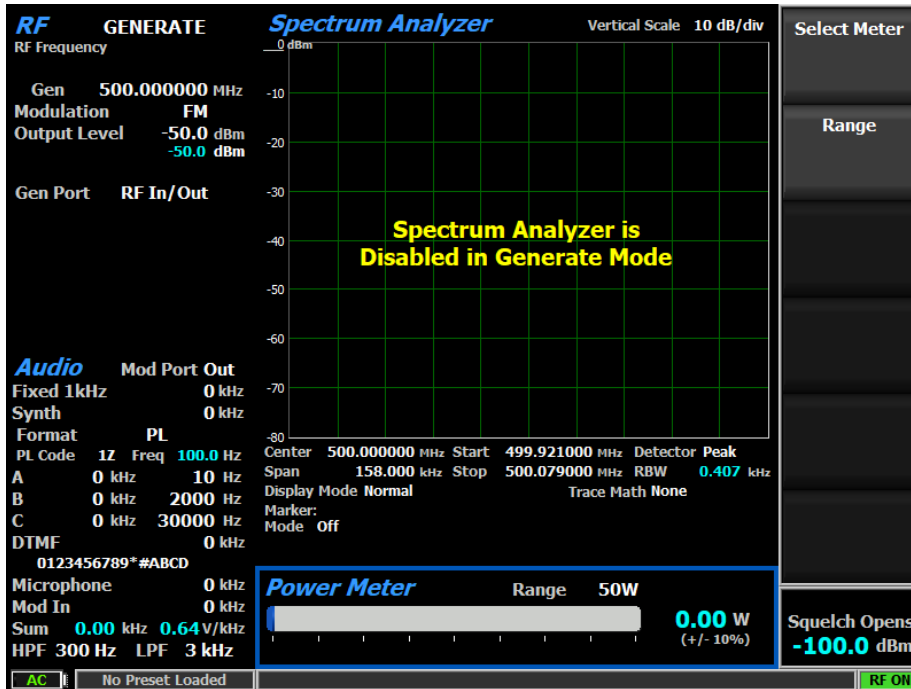

The METER Zone in the lower right-hand screen is activated by pressing the top-level **METER Zone** soft key or **Hot Key 5**. It contains the metering display for the receiver. The R8200 offers a Power Meter, Voltmeter, SINAD/Distortion, Decoder, Frequency Counter, RF Scan, and SNR meter to provide detailed analysis of the RF carrier as well as the recovered baseband content. For individual meter descriptions, see ["Introducing the Meters" on page 100](#).

For METER Zone soft key definitions, ranges, discrete and default values, and detailed notes, see ["METER Zone Soft Keys for Generate Mode" on page 451](#).

See the following section, ["Producing LMR Signals in Generate Mode" on the next page](#) for a simple procedure verifying the basic analog functionality of the radio's RF receiver and physical layer protocol using the R8200 in Generate Mode.

Producing LMR Signals in Generate Mode

This section provides an example verification measurement of a portable radio's digital signal processing without the need for specialized power supplies, test boxes, or radio service software. It can be completed using only the radio, a single BNC cable, and two adapters. This section describes a simple procedure for verifying the basic analog functionality of the radio's RF receiver and physical layer protocol using the R8200 in Generate Mode. Follow these steps to connect the radio to the R8200 and configure your measurement.

NOTE

This procedure begins at the where **"Measuring LMR Signals in Monitor Mode" on page 63** ends.

Required Equipment

- Freedom R8200 Communications System Analyzer
- Portable Radio, programmed for Project 25 (i.e., Motorola APX 6000 or similar)
- Cable, coax, BNC (m-m)
- Adapter, Type N(f)-to-BNC(f)
- Adapter, SMA(f)-to-BNC(f)

Video Support

A video of this receiver verification procedure is available on the Freedom Communication Technologies YouTube channel at <https://youtu.be/tJsqkOedFQU>.

Test Setup

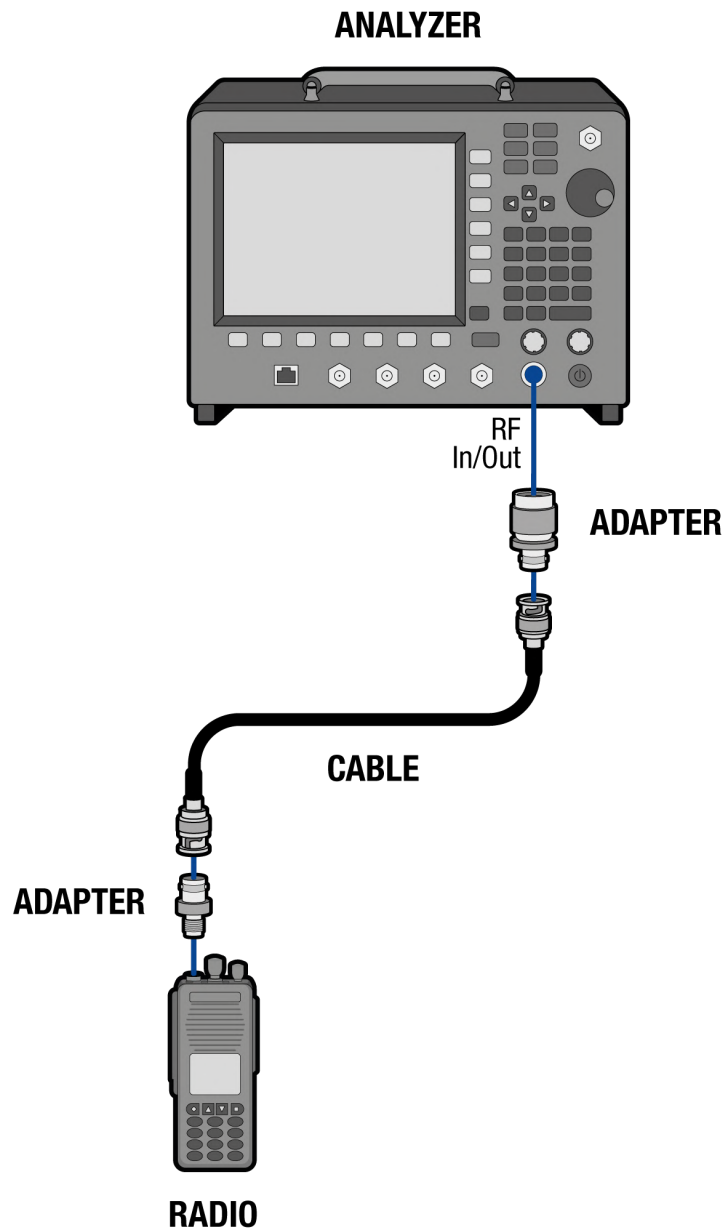

Procedure

Steps	Actions	Notes
1. Configure the R8200	<p>a. While still in Monitor Mode, to quickly set the generator output to the proper frequency, press Copy Frequency to Generator.</p> <p>b. To do the same with the NAC parameter, press Hot Key 4 > Copy NAC to Generator.</p> <p>c. To begin transmitting RF from the R8200, press Generate.</p> <p>d. To generate a standard P25 test pattern, press Gen Test Pattern > 1011 Hz Tone.</p> <p>e. To modulate the RF carrier, press Modulation Mode > Continuous.</p>	
2. Listen for the 1 kHz tone broadcast from the radio's speaker.	a. Adjust the volume of the 1011 Hz tone using the radio's On/Off/Volume Knob.	This verifies that the radio correctly decodes the PROJECT 25 baseband content.
3. Test the sensitivity of the radio.	<p>a. To adjust the Output Level of the R8200, press Hot Key 1 > Output Level.</p> <p>b. Decrease the Output Level until the tone is no longer heard.</p> <p>c. Confirm the RF Output Level is <i>less than -120 dBm</i> when the tone disappears.</p>	This confirms that the radio receiver is sensitive to transmissions as weak as -120 dBm.

Having confirmed these reception parameters, you can verify this radio is working in PROJECT 25 Test Mode.

4 Using Duplex Mode

This chapter explains how to use the analyzer as a stand-alone transceiver for testing LMR radios. It includes an overview of Duplex Mode, its use model and display features, with links to the detailed soft key reference and an example measurement configuration.

See **"Introducing Duplex Mode" on the next page** for an introduction to the Duplex Mode display and use model.

See **"Verifying LMR Performance in Duplex Mode" on page 87** for step-by-step instructions on configuring the R8200, connecting it to the radio, and configuring the radio to make an initial measurement of the entire RF signal path of the radio.

Introducing Duplex Mode

Duplex Mode combines the functionality of the Monitor and Generator modes. The analyzer operates as a stand-alone RF transceiver for testing LMR portables, mobiles, and system infrastructure. It provides simultaneous generator and monitor operation for testing radio transceivers with full duplex capability or radio systems with offset transmit and receive frequencies. All Generate and Monitor Mode RF parameters are independently adjustable in Duplex Mode except the shared functions of modulation type and bandwidth. Duplex Mode provides offset frequency operation of the generator and monitor over the full frequency range of the R8200.

NOTE

If RF Level Offset is enabled, the Gen Port and Mon Port labels are cyan-colored, indicating that Output Level amplitudes and RX measurements are adjusted by the Gen Port and Mon Port-specific offsets.

Its receiver is capable of monitoring over the air (OTA) RF signals through its Antenna port or via direct connection to the transmitter through the RF In/Out port. Its transmitted RF carrier is accessible through the RF Gen Out or RF In/Out ports for over the air (OTA) operation via antenna broadcast or direct coupling via cabling to a receiver. The output level is adjustable from -95 dBm to $+5$ dBm on the RF Gen Out port, and -130 dBm to -30 dBm on the RF In/Out port. The operating frequency range is 250 kHz to 3 GHz in 1 Hz increments with selectable bandwidths between 6.25 kHz and 200 kHz.

The transmitter produces AM and FM carriers and a variety of baseband encoding formats. Its receiver provides signal strength, frequency accuracy, and other metering results while decoding the messages on incoming RF carriers to produce a recovered baseband signal. Additional analysis is provided by a Single-Port Vector Network Analyzer, Spectrum Analyzer, a Modulation Scope, a Dual Display (combined display of the aforementioned), an Oscilloscope, a Tracking Generator, and a Cable Fault Locator. When activated by pressing the blue mode key, the Duplex Mode is displayed as shown.

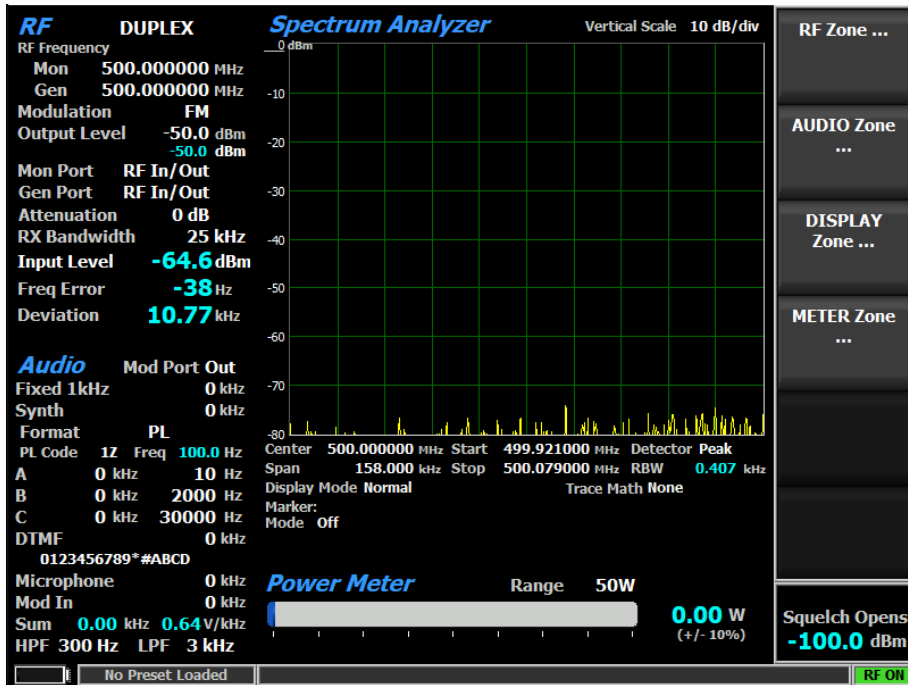

The following sections explain the functional parameters associated with the RF, DISPLAY, AUDIO, and METER Zones, respectively.

RF Zone

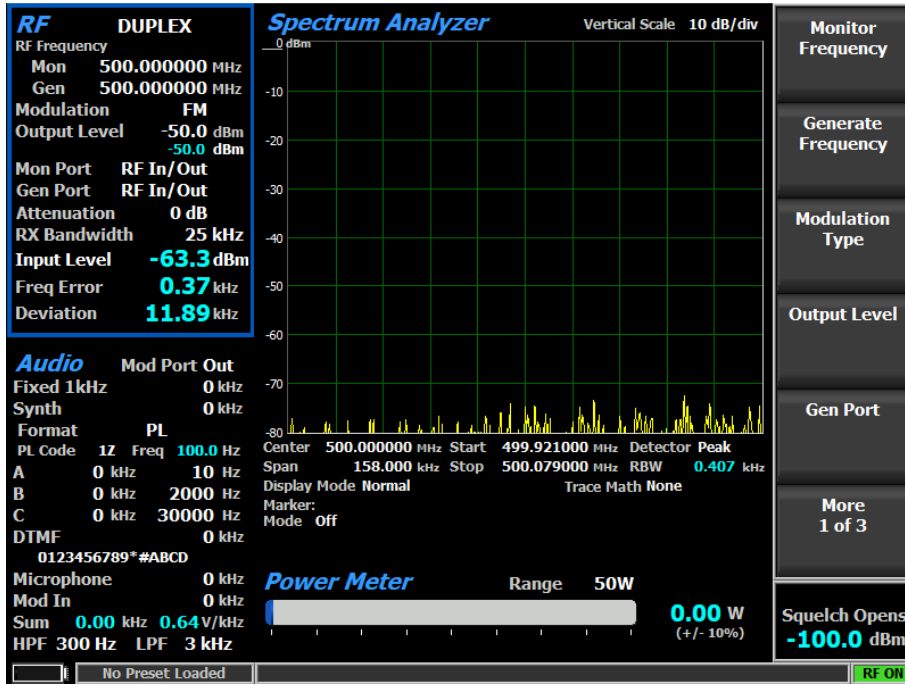

The RF Zone in the upper left-hand screen is activated by pressing the top-level **RF Zone** soft key or **Hot Key 1**. It displays the following adjustable parameters: Mon (receiver center frequency), Gen (transmitter center frequency), Duplex Offset, Modulation (type), (transmitter) Output Level (RF output power/voltage), Output Units, Mon Port (receiver input), Input Source, Input Units, Gen Port (transmitter output), Attenuation, Pre-Amplifier, and RX (receiver) Bandwidth. It also displays three fields of automated carrier measurements: Input Level, Freq Error (frequency error), and (frequency) Deviation.

NOTE

When the RF input power on the RF In/Out port is above +20 dBm (100 mW), the R8200 utilizes a broadband power detector for the measurement. The Input Level field in the RF Zone changes to Watt Meter to indicate broadband power measurement.

Input Level – Displays the RF input level of the received carrier. Different units may be selected using the Input Level Units soft key.

Watt Meter – Displays the level of broadband power applied to the RF In/Out port. For increased Watt Meter accuracy, disable the Pre-amplifier in Monitor Mode (press **Settings** > **System Settings** > **More** × 2 > **Pre-Amplifier Auto Off** > **Enable**), and in Generate Mode, set the Gen Port to RF In/Out (press **Generate** > **Gen Port** > **RF In/Out**).

Freq Error – Displays the frequency difference between the received carrier frequency and the R8200 current Monitor Center Frequency.

Deviation – When the selected modulation type is FM, displays the positive peak frequency deviation of the received modulated carrier (i.e., from the Frequency Error mean). Negative peak frequency deviation can be observed by selecting Bar Graphs in the DISPLAY Zone (press **DISPLAY Zone** > **Select Display** > **Bar Graphs**).

%AM – When the selected modulation type is AM, displays the positive peak AM percentage of the received modulated carrier.

For RF Zone soft key definitions, ranges, discrete and default values, and detailed notes, see "[RF Zone Soft Keys for Monitor Mode](#)" on page 352.

DISPLAY Zone

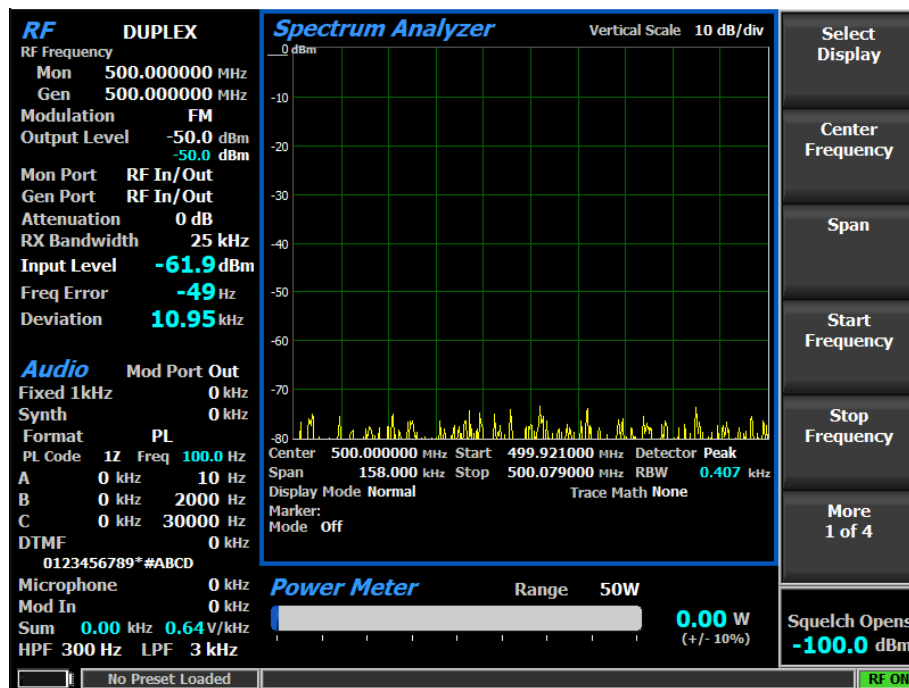

The DISPLAY Zone in the upper right-hand screen is activated by pressing the top-level **DISPLAY Zone** soft key or **Hot Key 2**. It contains the graticule for the graphical display of the current signal of interest providing a visual presentation of received RF signal measurements, recovered audio, internally-generated audio, and externally-measured audio signals. These include a Spectrum Analyzer, Modulation Scope, and Oscilloscope, along with Bar Graphs for RF signal deviation, frequency error and input level. The instrument type is shown at the top of the screen along with the vertical scale-per-division. Vertical scale and reference level are shown on the Y-axis. Frequency, Marker, and Trace Math parameters are shown below the X-axis. The yellow measurement trace is displayed on the graticule.

For individual bar graphs, see "**Bar Graphs**" below. For General Sequence, see "**General Sequence**" on page 83.

For details regarding the individual instrument displays, see:

- "**Introducing the Spectrum Analyzer**" on page 93
- "**Introducing the Modulation Scope**" on page 95
- "**Introducing the Oscilloscope**" on page 96
- "**Introducing the Dual Display**" on page 97
- "**Introducing the Tracking Generator**" on page 98
- "**Introducing the Cable Fault Locator**" on page 99
- "**Introducing the Meters**" on page 100

Bar Graphs

The Bar Graphs display provides a simultaneous analog and digital readout of critical signal characteristics. The analog display facilitates real time tuning adjustments of two-way radios while the digital reading provides precision in the measured result. The graph response can be smoothed using peak, power-weight, and RMS averaging. Press **Select Display** to enable a horizontal soft key menu of bar graph choices. Three bar graphs are displayed for the received carrier while in Monitor and Duplex Modes, as shown here when FM is selected as the Modulation Type.

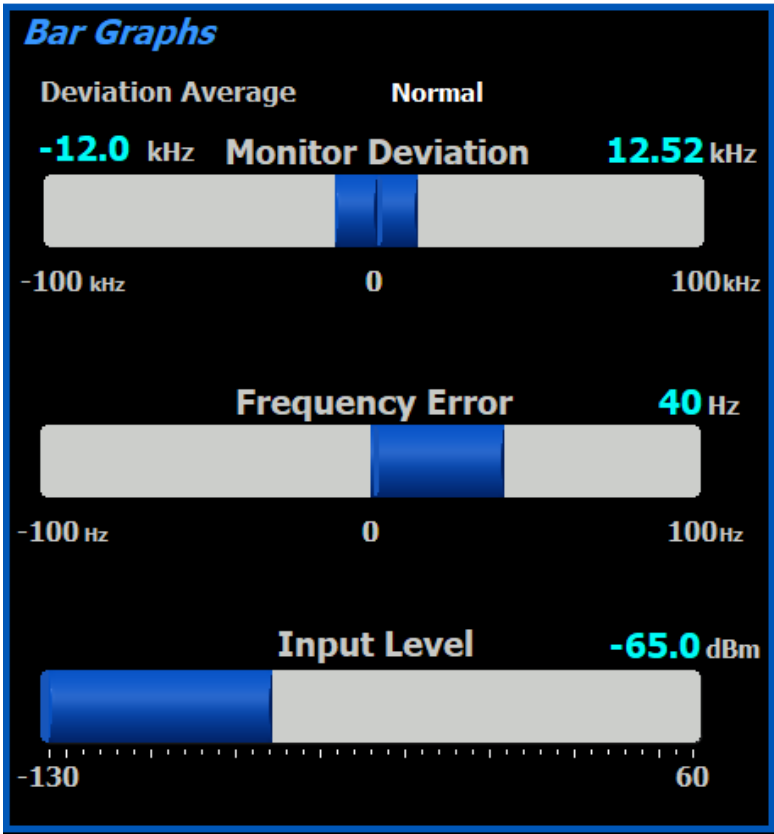

Monitor Deviation

This graph displays the negative and positive peak frequency deviation of a modulated carrier (i.e., from the Frequency Error mean), available when Modulation Mode is FM.

Monitor AM%

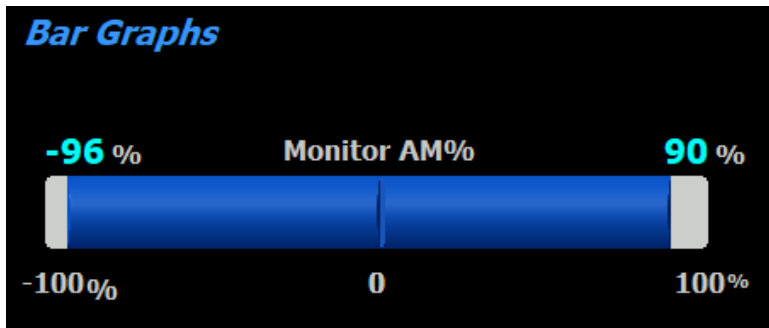

When Modulation mode is AM, this graph displays the negative and positive peak AM percentages of a modulated carrier.

Frequency Error

Represents the frequency difference (error) of the input carrier minus the current center frequency setting of the receiver (i.e., Monitor Frequency).

Input Level

Displays the RF input level of the carrier. Indicated units are Volts, Watts, or dBm as defined by the Input Level Units parameter in the RF Zone.

NOTE

When the RF input power on the RF In/Out port is above +20 dBm (100 mW), the R8200 utilizes a broadband power detector for the measurement. The Input Level field in the RF Zone changes to Watt Meter to indicate this measurement mode.

General Sequence

<i>General Sequence</i>					
Tone Standard			None		
	Freq (Hz)	Duration (sec)		Freq (Hz)	Duration (sec)
-	-	-	-	-	-
-	-	-	-	-	-
-	-	-	-	-	-
-	-	-	-	-	-
-	-	-	-	-	-
-	-	-	-	-	-
-	-	-	-	-	-
-	-	-	-	-	-
-	-	-	-	-	-
-	-	-	-	-	-
-	-	-	-	-	-
-	-	-	-	-	-
-	-	-	-	-	-
-	-	-	-	-	-
-	-	-	-	-	-
-	-	-	-	-	-
-	-	-	-	-	-
-	-	-	-	-	-
-	-	-	-	-	-
-	-	-	-	-	-
-	-	-	-	-	-

When General Sequence is selected as the Decoder in the METER Zone, the DISPLAY Zone is occupied by the General Sequence display which shows the current Tone Standard detected by the meter, as well as the frequency and duration of its 20 Tone Codes (0 to 9 and A to J).

For DISPLAY Zone soft key definitions, ranges, discrete and default values, and detailed notes, see **"DISPLAY Zone Soft Keys for Monitor Mode"** on page 383.

AUDIO Zone

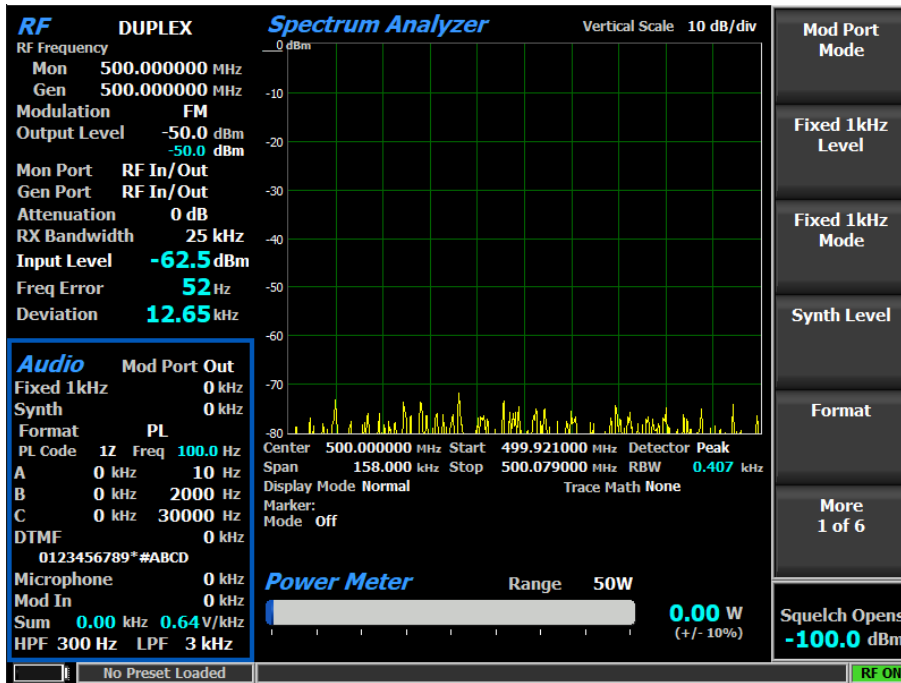

The AUDIO Zone in the lower left-hand screen is activated by pressing the top-level **AUDIO Zone** soft key or **Hot Key 4**. In Duplex Mode, the AUDIO Zone contains audio and baseband filter settings for encoding and retrieving baseband signals and a display of the current encoding/decoding format and voltage level.

NOTE

AUDIO Zone menu screens display common settings along with menu choices that change to reflect the Format (signal type) chosen for the audio synthesizer. Different submenu screens and settings appear when other encoding types such as DPL, A/B Sequence, or 5/6 Tone are selected with the Format soft key.

The AUDIO Zone parameters in Duplex Mode replicate those in Monitor Mode *with two key differences*.

- In Duplex Mode, the audio signal is applied simultaneously, as modulation to the RF carrier, and as a base band signal at the Mod In/Out connector.
- In Duplex Mode, (Mod) Sum level is shown in units of FM deviation (kHz) or AM modulation depth (%), depending on the current Modulation Type (FM or AM, respectively) displayed in the RF Zone.

Sum – displays the composite sum of all audio sources enabled in volts.

NOTE Decoding parameters for the carrier-recovered audio are primarily located in the METER Zone. See "**Decoder**" on page 102.

For AUDIO Zone soft key definitions, ranges, discrete and default values, and detailed notes, see "**AUDIO Zone Soft Keys for Duplex Mode**" on page 468.

METER Zone

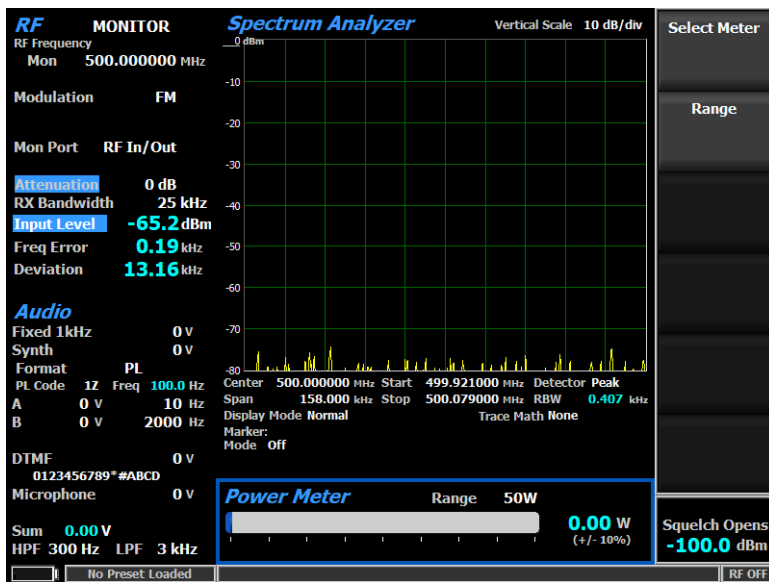

The METER Zone in the lower right-hand screen is activated by pressing the top-level **METER Zone** soft key or **Hot Key 5**. It contains the metering display for the receiver, represented in a dedicated area on the LCD screen below the DISPLAY Zone. The R8200 offers a Power Meter, Voltmeter, SINAD/Distortion, Decoder, Frequency Counter, RF Scan, and SNR meter to provide detailed analysis of the RF carrier as well as the recovered baseband content. For individual meter descriptions, see "**Introducing the Meters**" on page 100.

For METER Zone soft key definitions, ranges, discrete and default values, and detailed notes, see "**METER Zone Soft Keys for Duplex Mode**" on page 514.

See the following section, "**Verifying LMR Performance in Duplex Mode**" on the next page for instructions on configuring a simple FM transmitter test using Duplex Mode.

Verifying LMR Performance in Duplex Mode

This section provides an example measurement using the analyzer's Duplex Mode. Complete this procedure to make an initial verification measurement of a portable radio transceiver's FM analog signal processing without the need for specialized power supplies, test boxes, or radio service software. It can be completed using only the radio, a single BNC cable, and two adapters. This section describes a simple procedure for verifying the basic functionality of the radio's RF transceiver and physical layer protocol using the R8200 in Duplex Mode. Follow these steps to connect the radio to the R8200 and configure your measurement.

Required Equipment

- Freedom R8200 Communications System Analyzer
- Portable Radio
- Cable, coax, BNC (m-m)
- Adapter, Type N(f)-to-BNC(f)
- Adapter, SMA(f)-to-BNC(f)

Test Setup

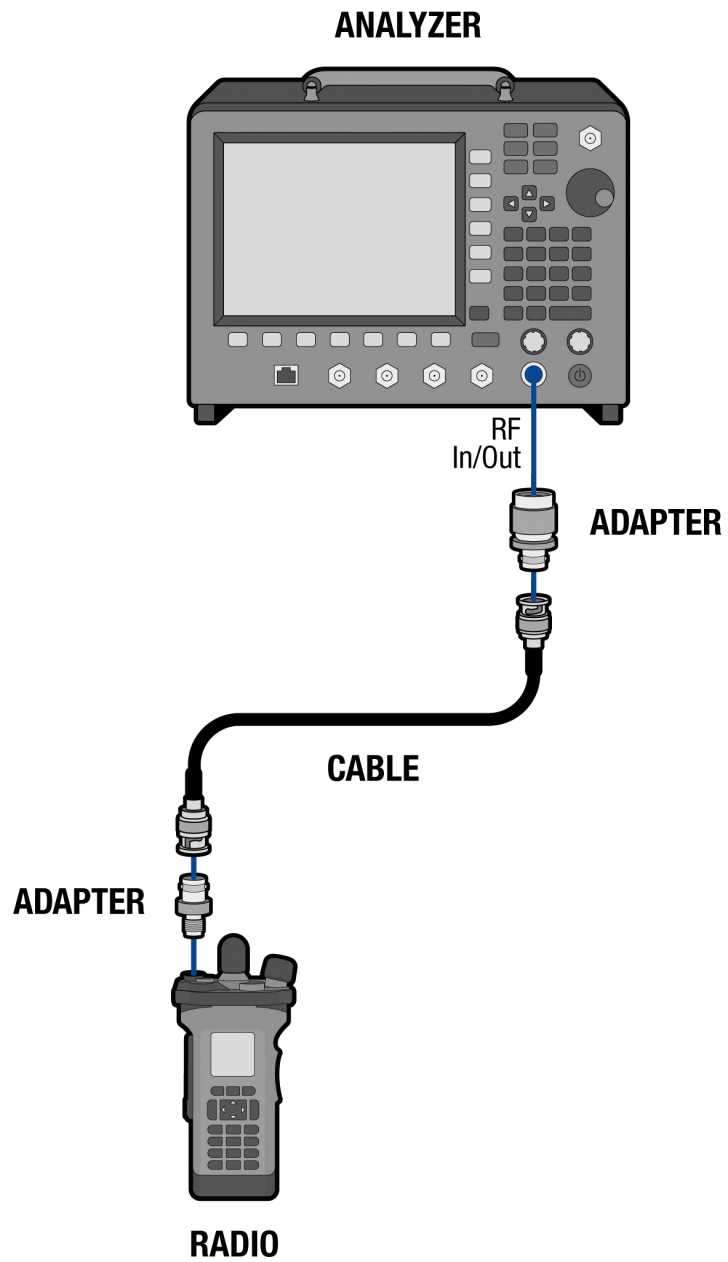

Procedure

Steps	Actions	Notes
1. Configure the test setup.	<p>a. Connect the Type N(f)-to-BNC(f) adapter to the R8200 RF In/Out port.</p> <p>b. Remove the antenna from the radio.</p> <p>c. Connect the SMA(f)-to-BNC(f) adapter to the Antenna port of the radio.</p> <p>d. Connect the BNC cable between the radio and the R8200.</p>	
2. Configure the R8200.	<p>a. Press Duplex.</p> <p>b. To set the receiver Center Frequency, press Hot Key 1 > Monitor Frequency > 403 > MHz.</p> <p>c. To set the transmit frequency to match the radio receiver press Generate Frequency >403 > MHz.</p> <p>d. To disable transmission from the R8200, press RF On/Off.</p> <p>e. In the RF Zone, confirm that Mon Port displays RF In/Out as the receiver's input.</p> <p>f. In the RF Zone, confirm that Gen port displays RF In/Out as the Gen Port.</p> <p>g. Confirm in RF Zone that Mod-</p>	<p>Alternatively, press RF Zone > Monitor Frequency > 403 > MHz.</p> <p>If not, press Mon Port > RF In/Out > Enter.</p> <p>If not, press Gen Port > RF In/Out > Enter.</p>

Steps	Actions	Notes
	ulation displays FM.	By default, the R8200 starts in FM modulation. If not, press Modulation Type > FM .
3. Activate and key the radio.	<ul style="list-style-type: none"> a. Turn the On/Off/Volume Knob clockwise to activate the radio. b. Press PTT on the portable. c. Speak into the radio microphone. 	This initiates a broadcast of the voice content input from the radio microphone. It may be necessary to adjust the volume to hear the demodulated voice on the R8200 speaker.
4. Observe the DISPLAY Zone.	<ul style="list-style-type: none"> a. Confirm that the Spectrum Analyzer displays the radio's transmitted carrier signal. 	You should observe a jump in signal on Spectrum Analyzer. Allow time for auto attenuation to activate and stabilize the Spectrum Analyzer level.
5. Observe the RF Zone.	<ul style="list-style-type: none"> a. Confirm that the Input Level displays the radio's output power. b. Verify measured power is at the level expected for radio. c. Confirm that Freq Error displays the radio's frequency error as <i>less than 100 Hz</i>. 	This verifies the operation of the radio's RF FM transmitter.
6. Configure the R8200.	<ul style="list-style-type: none"> a. To set a 1 kHz test tone, press Hot Key 4 > Fixed 1 kHz Level > 2.500 > Enter. b. To output the test tone, press Fixed 1 kHz Tone > Continuous. c. Press RF On/Off until RF ON is displayed in the lower right hand corner of the display. 	If generate frequency set above then no need to duplicate.
7. Listen for the 1 kHz tone broadcast from the radio's speaker.	<ul style="list-style-type: none"> a. Adjust the volume of the 1 kHz tone using the radio's On/Off/Volume Knob. 	This verifies that the radio correctly decoding the FM transmission from the R8200.

Steps	Actions	Notes
8. Test the sensitivity of the radio.	<ul style="list-style-type: none"> <li data-bbox="613 264 987 380">a. To adjust the Output Level of the R8200, press Hot Key 1 > Output Level. <li data-bbox="613 405 987 604">b. Use the arrow keys or the tuning knob to decrease the Output Level until the 1 kHz tone is no longer broadcast from the radio speaker. <li data-bbox="613 627 987 743">c. Confirm that the RF Output Level on the R8200 is <i>less than -120 dBm</i> when the tone disappears. 	This confirms that the radio receiver is sensitive to transmissions as weak as -120 dBm.

Having confirmed these parameters, you can verify that the transceiver on this radio is operating correctly in Analog FM Duplex Mode.

5 Using Instrument Mode

This chapter introduces Instrument Mode which provides full-screen versions of a variety of test equipment employed in the verification and maintenance of LMR portables, mobiles, and infrastructure systems. Instrument Mode provides frequency- and time-based analytical instruments, making detailed visual analysis of waveforms easier while providing additional measurement specific data fields. These instruments include a Single-Port Vector Network Analyzer, Spectrum Analyzer, Modulation Scope, and an Oscilloscope. Optional instruments include a Dual Display (combining a Spectrum Analyzer and Modulation Scope), Tracking Generator, and Cable Fault Locator. The metering devices available in the R8200's METER Zone are also offered from Instrument Mode.

NOTE

Enabling a full screen display in Instrument Mode suspends the standard operation of the R8200 (i.e., RF Zone, AUDIO Zone, etc.). To restore standard operation, press **Monitor**, **Generate**, or **Duplex**.

The following sections feature an overview of each individual instrument with a description of the display user interface followed by links to each instrument's soft key reference.

- ["Introducing the Spectrum Analyzer" on the next page](#)
- ["Introducing the Modulation Scope" on page 95](#)
- ["Introducing the Oscilloscope" on page 96](#)
- ["Introducing the Dual Display" on page 97](#)
- ["Introducing the Tracking Generator" on page 98](#)
- ["Introducing the Cable Fault Locator" on page 99](#)
- ["Introducing the Meters" on page 100](#)
- ["Introducing the Single-Port Vector Network Analyzer" on page 109](#)

Introducing the Spectrum Analyzer

The R8200 Instrument Mode is equipped with a stand-alone full-screen Spectrum Analyzer capable of analysis between 1 MHz and 3 GHz with +2 dB level accuracy and -140 dBm typical noise floor performance. It offers two absolute and delta markers frequency/power markers as well as a variety of measurement trace types. The Spectrum Analyzer display is shown below with an active marker.

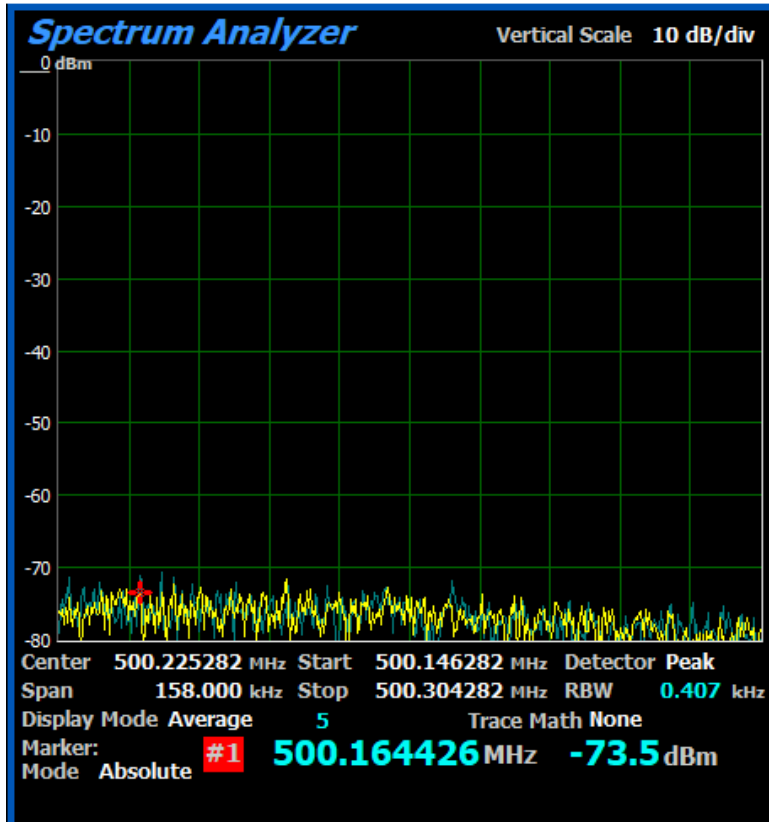

The instrument type is shown at the top of the screen along with the vertical scale-per-division. Vertical scale and reference level are shown on the Y-axis. Frequency, Resolution Bandwidth, Display Mode, Marker, and Trace Math parameters are shown below the X-axis. The yellow measurement trace as well as the blue reference trace are displayed on the graticule.

Display Mode Average – Displays the number of sweeps currently averaged to create the displayed measurement trace when the Display Mode is set to Averaging.

RBW – Displays the optimized resolution bandwidth based on the current frequency span and sweep time.

With the Enhanced Spectrum Analyzer option, up to seven markers and associated data can be activated on the Spectrum Analyzer display.

NOTE

For an R8200 without the Enhanced Spectrum Analyzer option, the Toggle Marker soft key activates the two available markers.

After enabling CW Harmonics and pressing Measure Harmonics, the Spectrum Analyzer measures and displays the relative power and frequency of the fundamental as well as the 2nd, 3rd, 4th, and 5th harmonics, as shown below.

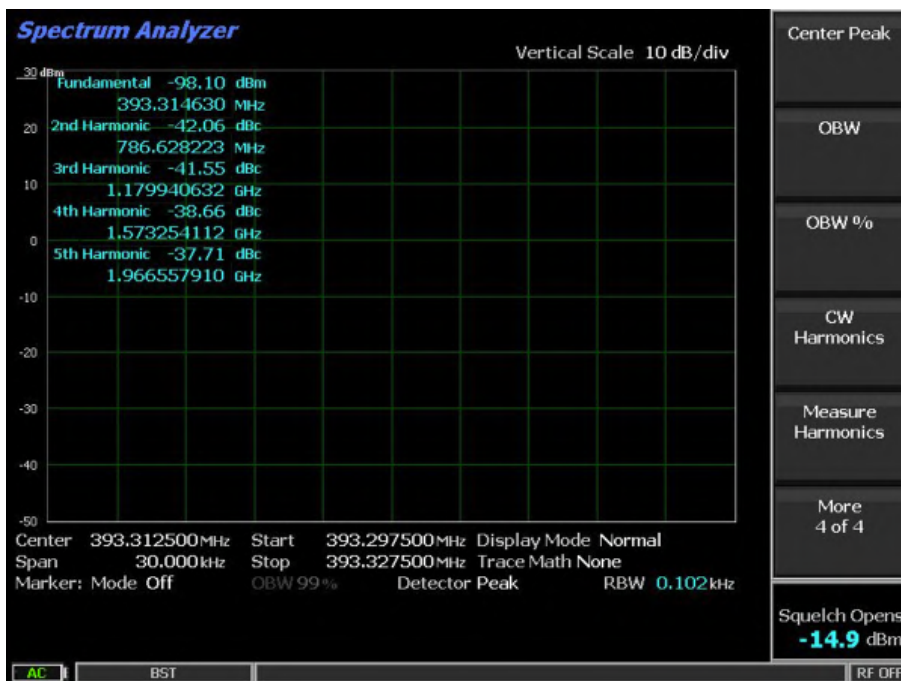

For Spectrum Analyzer soft key definitions, ranges, discrete and default values, and detailed notes, see "[Spectrum Analyzer Soft Keys](#)" on page 525.

Introducing the Modulation Scope

The R8200 Instrument Mode is equipped with a stand-alone full-screen Modulation Scope. It also appears as an available display in the DISPLAY Zone as well as one half of the Dual Display instrument. The Modulation Scope display is shown below.

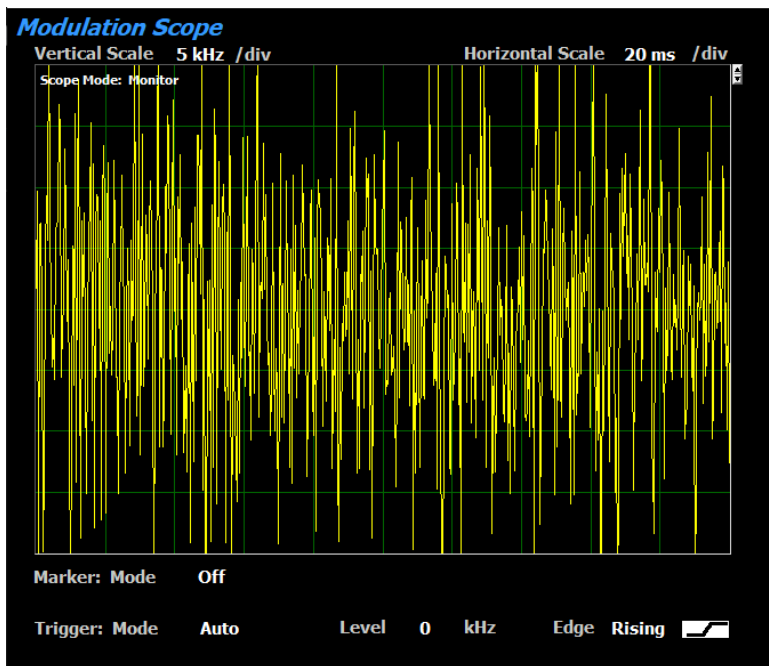

The Modulation Scope displays the internally-processed RF modulation waveforms. It automatically switches between Generator and Monitor modulation depending on which mode is selected. In Duplex Mode an additional soft key allows manual selection of the Monitor or Generator modulation waveform. Vertical and Horizontal Scale as well as Scope Mode are shown at the top of the screen. Marker Mode and Trigger parameters are shown below the X-axis. The yellow measurement trace is displayed on the graticule.

For Modulation Scope soft key definitions, ranges, discrete and default values, and detailed notes, see ["Modulation Scope Soft Keys" on page 535](#).

Introducing the Oscilloscope

The R8200 Instrument Mode is equipped with a stand-alone full-screen Oscilloscope. It also appears as an available display in the DISPLAY Zone.



This general-purpose Oscilloscope features calibrated vertical input sensitivities and automatic or triggered horizontal sweep rates. Use the Oscilloscope to analyze waveforms, detect asymmetric modulation or audio distortion, trace signals, and troubleshoot subsystems or circuits. The Meter In port serves as the vertical input for the Oscilloscope. Coupling, Vertical and Horizontal Scale as well as Maximum Recommended Input are shown at the top of the screen. Marker Mode and Trigger parameters are shown below the X-axis. The yellow measurement trace is displayed on the graticule.

For Oscilloscope scope soft key definitions, ranges, discrete and default values, and detailed notes, see "[Oscilloscope Soft Keys](#)" on page 539.

Introducing the Dual Display

The R8200 Instrument Mode is equipped with a stand-alone full-screen Dual Display. It also appears as an available display in the DISPLAY Zone.

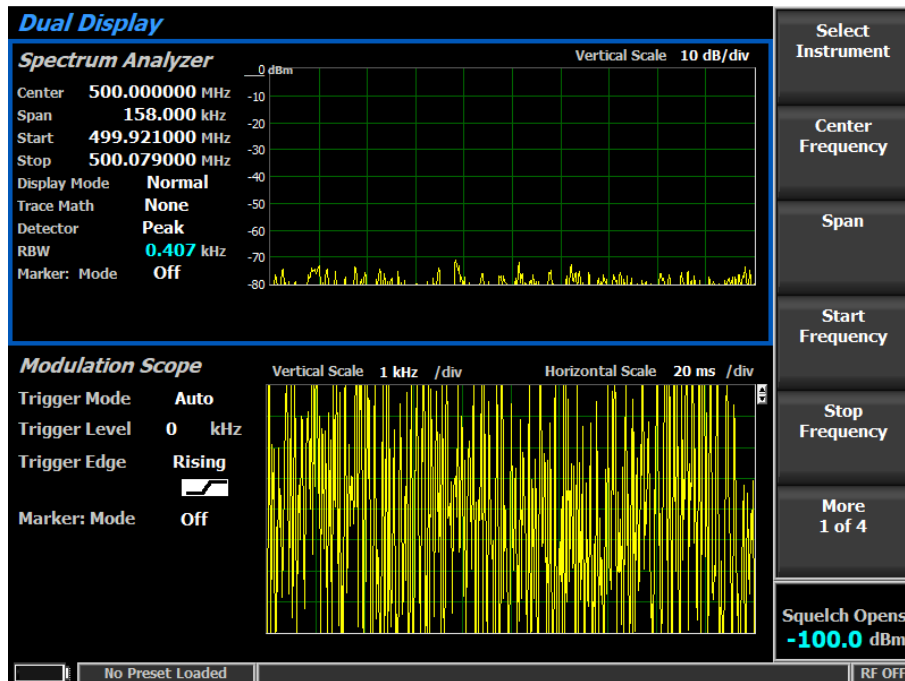

The optional Dual Display provides a convenient one screen presentation of two instruments often used together, the Spectrum Analyzer and Modulation Scope. This gives a user control and a simultaneous view of the results from both measurement functions. In Dual Display Mode the submenus, control, and parameter entry are unchanged from the full screen versions of each instrument.

For the upper portion of the Dual Display, the Spectrum Analyzer, the instrument type is shown at the top left of the screen along with the vertical scale-per-division and display mode. Vertical scale and reference level are shown on the Y-axis. Frequency, Resolution Bandwidth, Display Mode, Marker, and Trace Math parameters are shown to the left of the Y-axis. The yellow measurement trace as well as the blue reference trace are displayed on the graticule.

For the lower portion of the Dual Display, the Modulation Scope, the instrument type is shown at the top left of the screen along with Vertical and Horizontal Scale as well as Scope Mode. Marker Mode and Trigger parameters are shown to the left of the Y-axis. The yellow measurement trace is displayed on the graticule.

For Dual Display soft key definitions, ranges, discrete and default values, and detailed notes, see **"Dual Display Soft Keys"** on page 544.

Introducing the Tracking Generator

The R8200 Instrument Mode is equipped with an optional stand-alone full-screen Tracking Generator, as shown below.

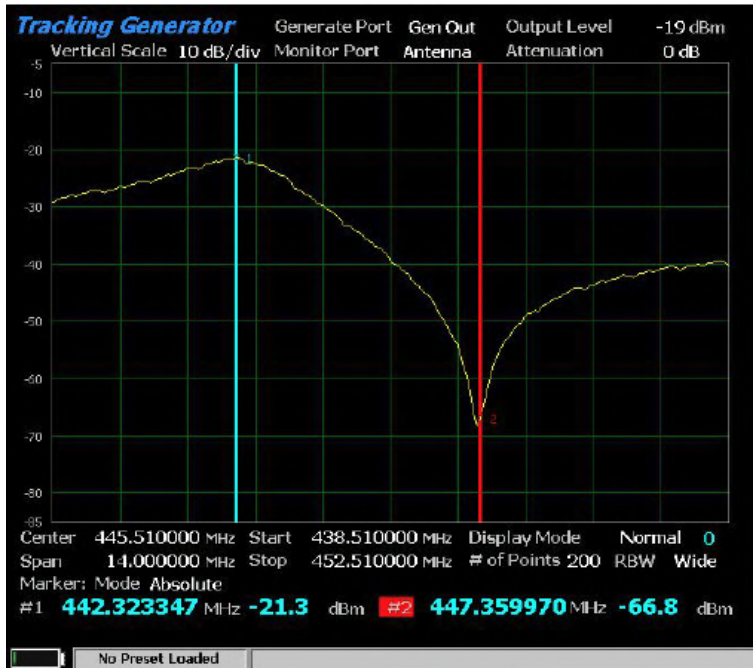

The optional Tracking Generator function sets up the R8200 RF generator in a sweeping mode for simultaneous use with the Spectrum Analyzer display. This delivers a valuable capability for measuring and servicing a wide variety of RF filtering and combining networks. The instrument type is shown at the top left of the screen along with the Vertical Scale, Generate Port, Output Level, Monitor Port, and Attenuation. Vertical scale and reference level are shown on the Y-axis. Frequency, Resolution Bandwidth, Display Mode, Marker, and Trace Math parameters are shown to the left of the Y-axis. The yellow measurement trace is displayed on the graticule.

For Tracking Generator soft key definitions, ranges, discrete and default values, and detailed notes, see **"Tracking Generator Soft Keys"** on page 557.

Introducing the Cable Fault Locator

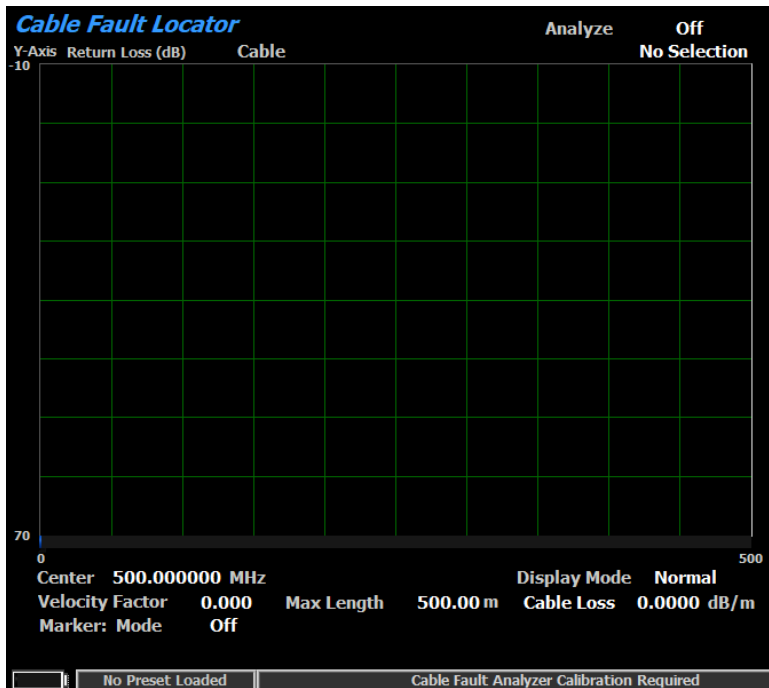

The optional Cable Fault Locator uses the R8200 Tracking Generator along with FFT analysis to determine distance to a fault or termination mismatch in RF cables. Pressing the Cable Fault Locator soft key provides the full screen display. The Cable Fault Locator is used with an optional directional coupler or splitter. The Cable Fault Locator has settings for entering cable parameters and display specifics. Several standard cable selections provide predetermined settings. You can also enter specific data for a cable under test and save these settings for future use. The instrument type is shown at the top left of the screen along with the Vertical Scale, Return Loss, Cable Type, and Analysis Mode. Vertical scale and reference level are shown on the Y-axis. Center Frequency, Display Mode, Maximum Length, Cable Loss, and Marker parameters are shown below the graticule. The yellow measurement trace is displayed on the graticule.

For Cable Fault Locator soft key definitions, ranges, discrete and default values, and detailed notes, see ["Cable Fault Locator Soft Keys" on page 567](#).

Introducing the Meters

The Instrument Mode is also equipped with access to all of the metering capabilities offered by the R8200. These are the same devices available by pressing either **METER Zone** or **Hot Key 5**.

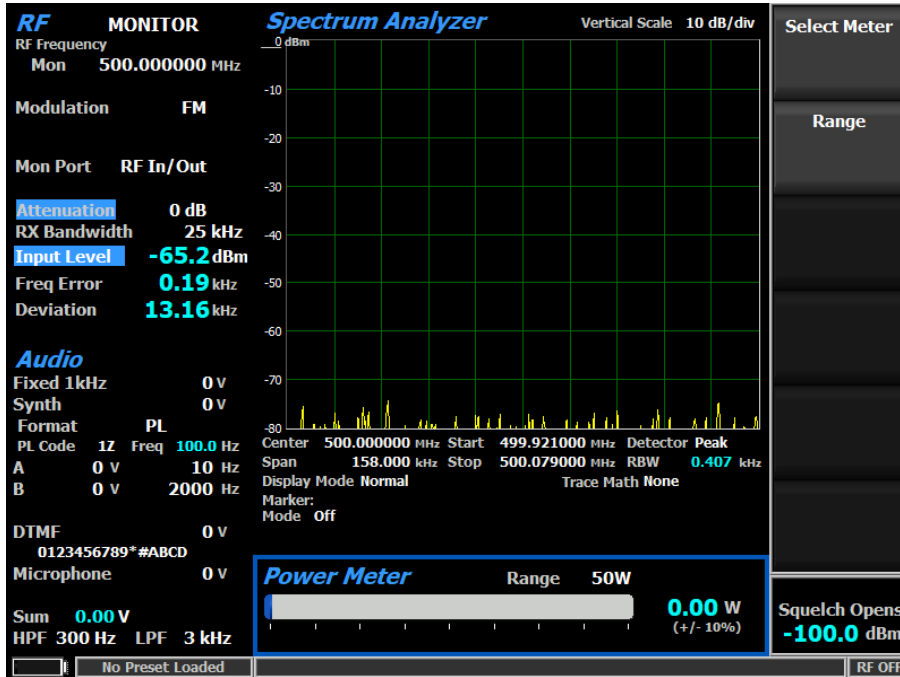

From the Instrument Mode main menu, access the metering devices by pressing **More > Other Meters**. This opens a horizontal soft key menu where you can select a Power Meter, Voltmeter, SINAD/Distortion, Decoder, Frequency Counter, RF Scan, and SNR meter to provide detailed analysis of the RF carrier as well as the recovered baseband content.

Power Meter

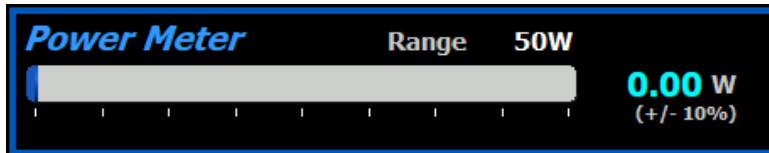

Provides a bar graph display and numeric readout in Watts of the broadband input power applied to the RF In/Out port. For a detailed reference of its parameter settings, see ["METER Zone Soft Keys for Monitor Mode" on page 401](#).

NOTE

For increased Power Meter accuracy, disable the Pre-amplifier in Monitor Mode (press **Settings** > **System Settings** > **More** × 2 > **Pre-Amplifier Auto Off** > **Enable**). In Generate Mode, set the Gen Port to RF In/Out (press **Generate** > **Gen Port** > **RF In/Out**).

Voltmeter

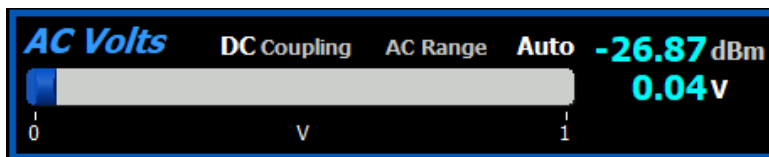

Measures the amplitude of AC and DC voltages at the Meter In port with adjustable range and dBr (normalized measurement between reference voltage and current input voltage; AC only). For a detailed reference of its parameter settings, see ["METER Zone Soft Keys for Monitor Mode" on page 401](#).

NOTE

The range on AC and DC must be set to 1 or 10 Volts to use 600 Ohm Input Impedance.

SINAD/Distortion Meter

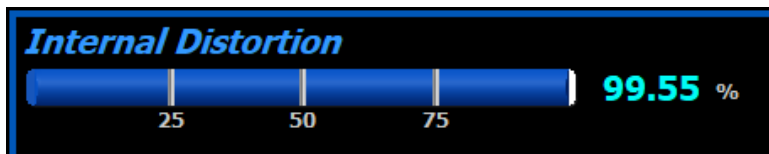
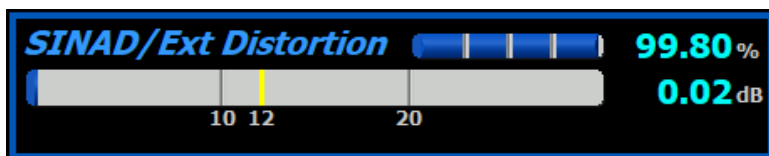

Provides Signal in Noise and Distortion (SINAD)/external distortion and internal distortion audio measurements. For a detailed reference of its parameter settings, see **"METER Zone Soft Keys for Monitor Mode" on page 401**.

In Monitor Mode, Internal Distortion measures the distortion in percent of the internally-recovered audio from a transmitter modulated with a 1 kHz sine wave.

In Generate and Duplex Modes, SINAD/Ext Distortion provides a SINAD and External Distortion measurement of the recovered audio signal applied to the Meter In port from an external radio. The test is performed using a 1 kHz modulated RF carrier applied to the radio's antenna port by the R8200. The RF level is adjusted in the RF Zone while monitoring the SINAD meter to determine the receiver sensitivity per EIA (12 dB yellow tick mark) and other standards.

Decoder

Provides a horizontal soft key menu enabling a suite of tone decoding functions, including PL/Period Counter, DPL Decode, DTMF Decode, 2-Tone Decode, 5/6 Decode, and General Sequence. For a detailed reference of its parameter settings, see **"METER Zone Soft Keys for Monitor Mode" on page 401**.

PL/Period Counter

<i>PL/Period Counter</i>		Decoding	Internal
Frequency	255.1 Hz	PL Code	??
		HP	1 Hz
		LP	300 Hz

Displays the frequency and numeric code of the recovered audio from a radio modulated with the Motorola Private-Line (PL) format. The period counter allows rapid high resolution measurements of non-PL low frequency modulation without the long gate times associated with frequency counting. Horizontal soft key menus provide adjustment of the Low and High Pass filters to reduce noise for more accurate measurements. Recommended filter settings for PL: HP= 1 Hz; LP = 300 Hz. For a detailed reference of its parameter settings, see **"METER Zone Soft Keys for Monitor Mode" on page 401**.

DPL Decode

<i>DPL Decode</i>		Decoding	Internal
DPL Code	???	HP	1 Hz
		LP	3 kHz

Displays a numeric code from the recovered audio modulated with the Motorola Digital Private-Line (DPL) format. Horizontal soft key menus provide adjustment of the Low and High Pass filters to reduce noise for more accurate measurements. Recommended filter settings for DPL: HP= 1 Hz; LP = 3 kHz.

DTMF Decode

<i>DTMF Decode</i>		Decoding	Internal
DTMF Code		HP	1 Hz
		LP	3 kHz

Decodes DTMF (Dual Tone Multi-Frequency) signals used in testing telephone interfaced systems. Horizontal soft key menus adjustment of the Low and High Pass filters to reduce noise for more accurate measurements. Recommended filter settings for DTMF: HP= 1 Hz; LP = 3 kHz.

NOTE

The R8200 displays the history of previously decoded DTMF codes, with the right-most code digit being replaced by the most recently decoded tone. The DTMF Code field appears static when the transmitted code is not changing or nothing is being decoded. Press **Reset** to clear the history.

2-Tone Decode

<i>2-Tone Decode</i>			Decoding	Internal
Tone 1	Hz	sec	HP	1 Hz
Tone 2	Hz	sec	LP	3 kHz

Decodes the two-tone sequential paging format. The meter displays the Tone A/Tone B (Tone 1 and Tone 2) frequencies and durations. Horizontal soft key menus provide adjustment of the Low and High Pass filters to reduce noise for more accurate measurements. Press **Decode** to start or stop decoding. Recommended filter settings for 2-Tone Decode: HP= 1 Hz; LP = 3 kHz.

5/6 Tone Decode

<i>5/6 Tone Decode</i>							Decoding	Internal
Cap Code	-	-	-	-	-	-	-	HP 1 Hz
Freq (Hz)	0	0	0	0	0	0	0	
Dur(sec)	0.000	0.000	0.000	0.000	0.000	0.000	0.000	LP 3 kHz

Decodes the 5/6 tone sequential paging format. The meter displays a table with the decoded cap code along with the individual tone frequencies and durations. A horizontal soft key menu enables selection of the meter sensitivity from MIN to MAX via the tuning knob, arrow keys, or repeated presses of **Sensitivity**. A horizontal soft key menu enables adjustment of the Low and High Pass filters to reduce noise for more accurate measurements. Recommended filter settings for 5/6 Tone: HP= 1 Hz; LP = 3 kHz.

General Sequence

<i>General Sequence</i>					
Tone Standard			None		
	Freq (Hz)	Duration (sec)		Freq (Hz)	Duration (sec)
1	-	-.---	11	-	-.---
2	-	-.---	12	-	-.---
3	-	-.---	13	-	-.---
4	-	-.---	14	-	-.---
5	-	-.---	15	-	-.---
6	-	-.---	16	-	-.---
7	-	-.---	17	-	-.---
8	-	-.---	18	-	-.---
9	-	-.---	19	-	-.---
10	-	-.---	20	-	-.---

<i>General Sequence</i>	Decoding	Internal
	HP	1 Hz
	LP	3 kHz

Decodes the individual frequency and time duration for up to 20 tones in a tone sequence. This table occupies the entire DISPLAY Zone and provides a detailed representation of the frequency and duration of the SelCall codes, as shown above. A horizontal soft key menu enables adjustment of the Low and High Pass filters to reduce noise for more accurate measurements, an Input Decoding selection key to select internal or external decoding, a Decode key with start and stop settings to control the decode function, and a selection window to choose the SelCall standard (or none) used for decoding. When a standard is selected, the decoded tones are mapped to the selected standard, and the Tone Code is listed with each tone in the table. When no standard is selected, the decoded tones are listed in numerical order. The recommended filter settings on the R8200 are: HP= 1 Hz; LP = 3 kHz.

NOTE

For correct operation, input tones should have a duration of 0.5 seconds or less.

Frequency Counter



In Monitor Mode, a general-purpose frequency counter with adjustable resolution for the recovered baseband audio or IF frequency displayed in the Modulation Scope. In Generate Mode, the counter measures the frequency of the internal or external modulation applied to the RF carrier. In External Scope Mode, the counter measures the frequency of signals applied to the Meter In port.

RF Scan

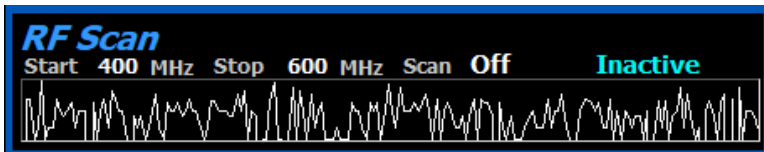

Searches for the strongest RF signal above the Squelch threshold setting on the active RF input port. The R8200 locks onto and automatically centers its operating frequency on this carrier. The search frequency range in MHz is entered using Start Frequency and Stop Frequency soft keys. Scanning begins when you press **Scan > Start**. Scanning is terminated by pressing **Scan > Off**. The meter graph displays an automatically-scaled spectrum of the entire scan range. Once a signal is acquired, the RF Scan meter stays locked on that frequency even if the carrier disappears. It resumes scanning once the **Scan > Single** or **Auto** are pressed. The RF Scan meter operates only when it is high-lighted; otherwise, it becomes inactive.

SNR

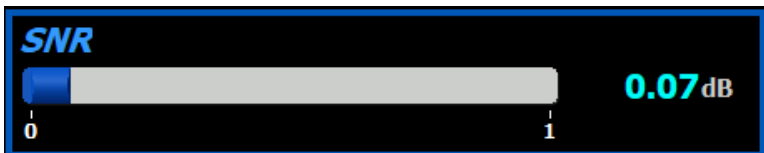

Measures signal-to-noise ratio at the selected Monitor port.

For METER Zone soft key definitions, ranges, discrete and default values, and detailed notes, see "**METER Zone Soft Keys for Monitor Mode**" on page 401.

Using the Single-Port VNA

This section describes the Single-Port Vector Network Analyzer featured in the R8200 Communications System Analyzer and explains how to use it to perform common verification and measurement tasks for LMR portables, mobiles, and infrastructure systems.

"Introducing the Single-Port Vector Network Analyzer" on the next page describes the instrument's display and covers important aspects of its use, including its calibration kit and common cables libraries.

"Calibrating the VNA" on page 116 explains how to maintain critical measurement accuracy by keeping the instrument calibrated.

"Measuring Return Loss and VSWR" on page 128 offers step-by-step instructions for measuring Return Loss or Voltage Standing Wave Ratio, an important part of maintaining high performance signal transmission lines.

"Measuring Distance To Fault" on page 139 offers step-by-step instructions for using the Distance To Fault display to quickly characterize and locate damaged cables and transmission lines.

"Measuring Normalized Impedance" on page 135 contains step-by-step instructions for using the Smith Chart display to quickly characterize a bandpass filter.

"Using the Calibration Kit Library" on page 124 explains how to use stock calibration kits as well as custom calibration kits.

"Using the Cable List" on page 144 offers step-by-step instructions for using the Cable List to increase your measurement accuracy.

Introducing the Single-Port Vector Network Analyzer

The R8200 offers a Single-Port VNA designed to analyze forward reflected power for RF sub-assemblies, circuits, and components from 1 MHz to 6 GHz. The Single-Port VNA display includes a magnitude plot and a Smith chart. It features up to seven absolute and/or delta markers simultaneously viewable within the magnitude plot, as well as a peak search threshold setting to clarify signals of interest prior to marker assignment. Sweep sampling is configurable up to 10001 measurement points with trace smoothing, averaging, scaling and adjustable IF bandwidths, start/stop or center/span frequency entry, as well as libraries containing preset characterization data for many industry standard cal kits and common cable assemblies. Error correction improves high frequency measurement accuracy. The R8200 has two error correction modes: the default mode using a calibration data set generated by a factory calibration, and a user-defined mode which generates a custom calibration data set based on the measurement at hand using the supplied Open/Short/Load (OSL) calibration kit. For details, see ["Error Correction" on the next page](#).

Use the VNA to make near-instantaneous measurements of Return Loss (RL) and Voltage Standing Wave Ratio (VSWR) for cables and antennae. Use Distance To Fault (DTF) to pinpoint impedance problems by first entering the length of the cable under test and cable type (i.e., velocity factor and frequency response), then calibrating the measurement plane before connecting the cable to it and inspecting different sections of the cable for RL anomalies. The DTF function employs a time domain transformation of a Frequency Domain Reflectometer (FDR) to display RL between any two points (the start distance and the stop distance) on a transmission line. The DTF display can clearly represent impedance discontinuities at discrete points along the signal path, enabling quick recognition and accurate pinpointing of compromised locations along transmission lines. The DTF display can also locate incoherence generated by other component irregularities in the signal path to significantly reduce troubleshooting and repair time. Use the Smith chart to measure normalized impedance to investigate the nature of reflection coefficients between different components of your LMR portable, mobile, or infrastructure system.

For detailed information on each adjustable measurement parameter including default value, range, and saved state, see ["Single-Port VNA Soft Keys" on page 576](#).

Display

The VNA features a RL/VSWR display (a magnitude plot) and a DTF display (RL versus distance) both with up to 6 trace markers configurable as Absolute or Delta representations of signal frequency and power, as well as a Smith Chart, an editable Cable List, and Calibration Kit Library. Measurements and measurement parameters are accessed and adjusted via soft key selections or dialog and data field entries.

Depending on the current measurement display, important measurement parameters are displayed above the status bar below the graticule. Frequency span information and other parameters associated with a particular measurement are displayed closest to the graticule, while other common parameters are displayed below. These include Error Correction status, Number of Points sampled, IFBW, Output Level, Trigger Mode, Averaging, Averaging Factor, Smoothing, and Smoothing Aperture.

Error Correction

The VNA has two error correction modes: factory calibration based mode and a measurement calibration based mode. Factory error correction is the default mode. One of the two modes is always enabled.

Default Calibration Error Correction – the calibration data set was generated by a default calibration at the factory using 10001 samples (the maximum number of points) at 10 kHz IF bandwidth from 1 MHz to 6 GHz (the full frequency range of the VNA).

User Calibration Error Correction – the calibration data set was generated by the most recent measurement calibration using the number of points and frequency range defined by the user.

NOTE

The Default factory calibration is performed at the Type N(f) connector of the TNC(m) to Type N(f) adapter attached to the VNA port. This makes the plane of reference for the Default error correction the Type N(f) connector of the TNC(m) to Type-N(f) adapter attached to the VNA port. Connect your DUT directly to the TNC(m) to Type N(f) adapter when using Default Error Correction. If a supplementary transmission line is necessary to connect the DUT to the VNA port, perform a user-defined calibration prior to device measurement.

The Correction field located in the lower left-hand corner of every VNA display reports the current source and status of error correction in regard to the validity of the measurement trace. See the following table.

Correction Field	Error Correction State
Def	Default Error Correction, based on the calibration data set generated by the factory default calibration over 10001 points, at 10 kHz IFBW, from 1 MHz to 6 GHz.
User	User-Defined Error Correction, based on the calibration data set generated by the most recent measurement calibration configured and performed by the user.
Ext (Extrapolated)	User-Defined Error Correction is currently <i>extrapolated</i> because one or more of the display settings (typically a frequency or distance setting) exceeds the integer boundaries of the user-defined measurement calibration data set.
Int (Interpolated)	User-Defined Error Correction is currently <i>interpolated</i> because two or more of the display settings (typically a frequency or distance setting) falls between two consecutive data points sampled during user-defined measurement calibration as circumscribed by the value set for the Number of Points parameter.

For example, if you configure a return loss measurement with a start frequency at 1 GHz, stop frequency at 2 GHz, and the number of points sampled was 1001, and then perform a calibration, your calibration would store the frequency response for 1.00 GHz, 1.01 GHz, 1.02 GHz, 1.03 GHz ... continuing in 10 MHz steps up to 2.00 GHz correcting for measurement error at every point in the data set.

Once your device is connected with the Trigger Mode set to Auto, the return loss is displayed as a yellow trace on the magnitude plot while the Correction field below the graticule would display User. If the stop frequency is increased to 3 GHz, the Correction field would display Ext. This indicates that the portion of the current display between 2 GHz and 3 GHz is being extrapolated or predicted from the lower frequency values contained in the calibration data set, and therefore it may not be a valid representation of the device's actual return loss between 2 GHz and 3 GHz.

If the start frequency is changed to 1.001 GHz and the stop frequency is changed to 1.009 GHz, the Correction field would display Int. This indicates that the portion of the current display between 1.001 GHz and 1.009 GHz is being interpolated or predicted from the lower (1 GHz) and upper (1.01 GHz) point (representing RL values) contained in the calibration data set, and therefore it may not be a valid representation of the device's actual return loss between 1.001 GHz and 1.009 GHz.

Return Loss/VSWR

The magnitude plot is designed to characterize the RL/VSWR of your device under test (DUT). To measure RL/VSWR, enter the desired frequency range and number of points for the measurement sample, then calibrate the measurement plane before connecting your DUT to display the measurement. The RL/VSWR display is shown below.

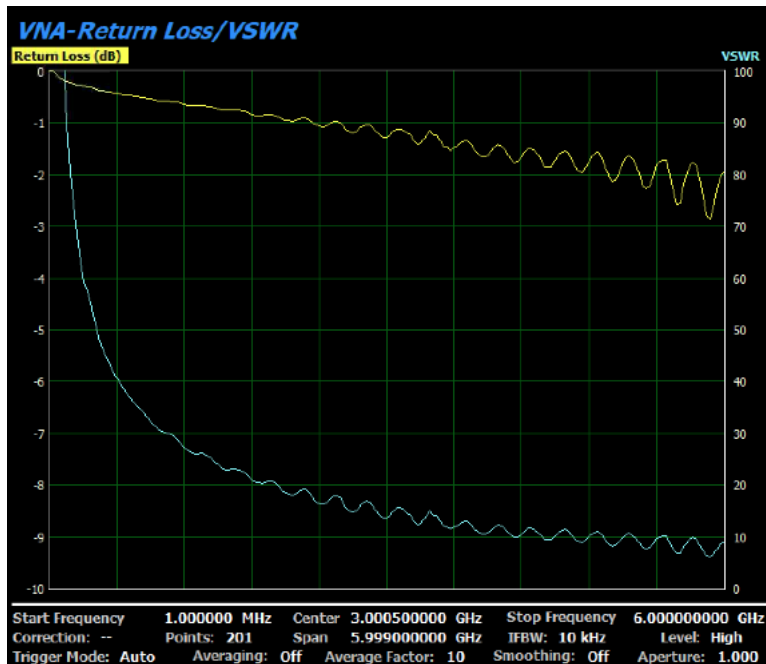

The vertical scale displays RL in dB. The horizontal scale of the magnitude plot always displays the frequency span of the current measurement with start frequency on the left, center frequency (above) and span (below) in the middle, and stop frequency on the right. Graph dimensions are updated by changes to the start frequency, stop frequency, center frequency, or span on the horizontal scale or changes to the reference power level or scaling on the vertical scale.

The yellow Return Loss (dB) label is displayed above the left vertical graticule. It represents the current reference level scale in deciBels. Measured RL is displayed as a yellow trace indicating the frequency response of the DUT to a theoretically flat (i.e., constant power) stimulus swept between the start and stop frequencies.

The cyan VSWR label is shown above the right graticule. It displays the ratio of maximum to minimum voltage for the standing wave. The standing wave is created by the additive and subtractive aspects of the incident and reflected potentials on the transmission line. The VSWR scale displays ratios from 0:1 to 100:1 on the vertical scale across the current frequency span displayed on the horizontal scale.

Important RL/VSWR measurement parameters are displayed above the status bar below the graticule. In addition to frequency span information, these include Error Correction status, Number of Points sampled, IFBW, Output Level, Trigger Mode, Averaging, Averaging Factor, Smoothing, and Smoothing Aperture.

Up to seven markers can be employed to simultaneously monitor the frequency and amplitude at an array of points along the DUT.

See ["Measuring Return Loss and VSWR" on page 128](#) for step-by-step measurement instructions.

Distance To Fault

The return-loss-versus-distance plot comprising the Distance To Fault display is shown below.

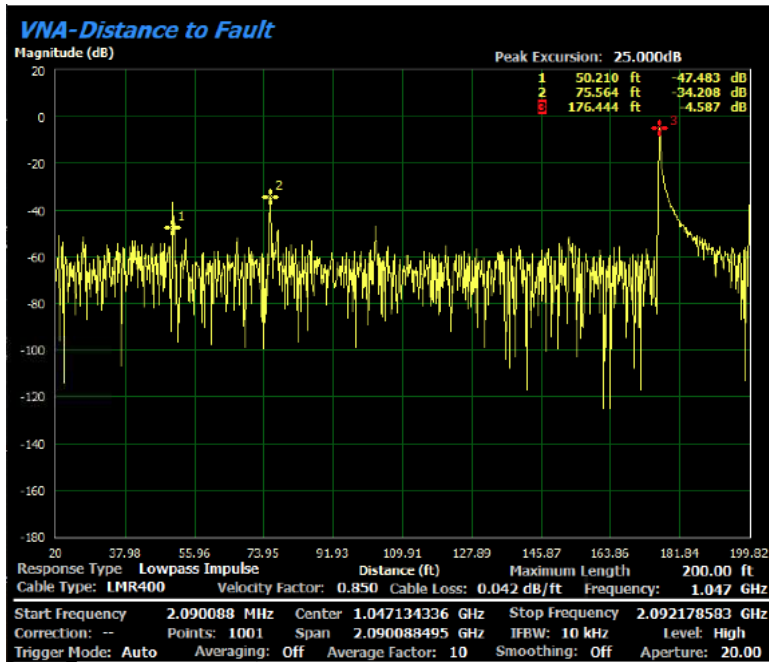

The vertical scale measures the RL of the DUT in dB. The DTF display's horizontal scale measures distance in feet or meters. It is defined by the start and stop distance. These values display the RL for a particular section of cable as defined by these two parameters. The start distance displays the RL for the DUT at a point measured in feet (or meters) from the plane of reference (typically the input connector on the transmission line). The stop distance displays the return loss for the DUT at a second point measured in feet or meters from the plane of reference. The horizontal scale of the Distance To Fault display typically depicts the incremental points between the start distance on the left and the stop distance on the right, showing the return loss for a subsection of the transmission line.

The *measurement* plane (i.e., the plane of reference for both the calibration and the device measurement) on the other hand is defined by the velocity factor and frequency response of the transmission line and Maximum Length value (i.e., the transmission line's total length). The transmission line's length, velocity factor, and frequency response determine the optimal frequency sweep. This optimized sweep is employed for both the calibration and the subsequent device measurement. After calibration, error correction is enabled to increase measurement accuracy across the length of the cable defined by the Maximum Length parameter during the critical DUT measurements.

In essence, the start and stop distances (along with vertical scaling via the Scale and Ref Value soft keys) enable zooming in and out on different sections of the cable for increased measurement resolution. Zooming is helpful when investigating suspect areas of relatively small but sudden changes in return loss associated with impedance discontinuities that imply faults or other damage to the DUT.

Up to seven markers can be employed to simultaneously monitor the distance from the reference plane peak and magnitude of return loss at an array of points along the DUT.

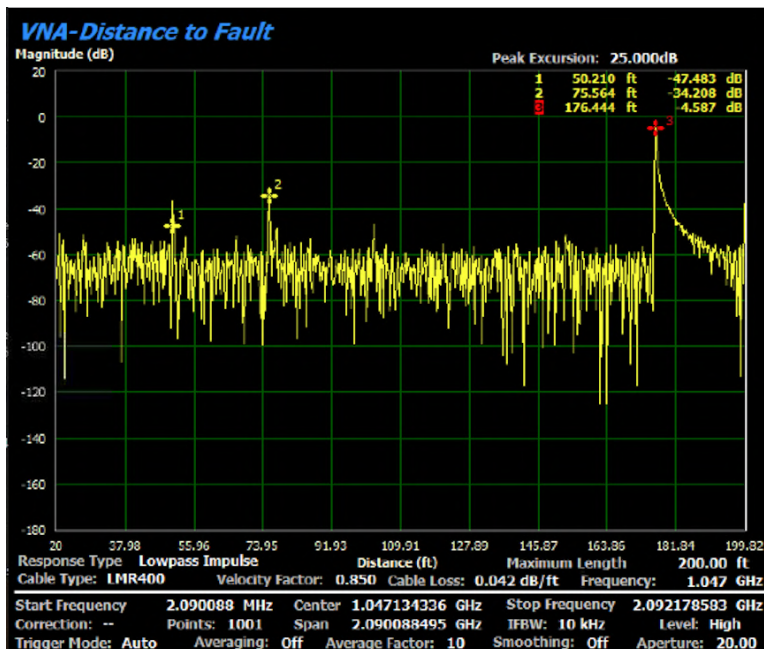

Important DTF measurement parameters are displayed above the status bar below the graticule. These include Response Type, Maximum Length, Cable Type, Velocity Factor, Cable Loss, Cable Loss Frequency, Frequency Values, Error Correction status, Number of Points sampled, IFBW, Output Level, Trigger Mode, Averaging, Averaging Factor, Smoothing, and Smoothing Aperture.

See **"Measuring Distance To Fault" on page 139** for step-by-step measurement instructions.

Normalized Impedance

The Smith Chart display is designed to characterize the Normalized Impedance (NI) of your device under test (DUT). The NI of a 20 MHz bandpass filter sampled across 401 frequencies from 10 MHz to 30 MHz using an IFBW of 10 kHz is shown below.

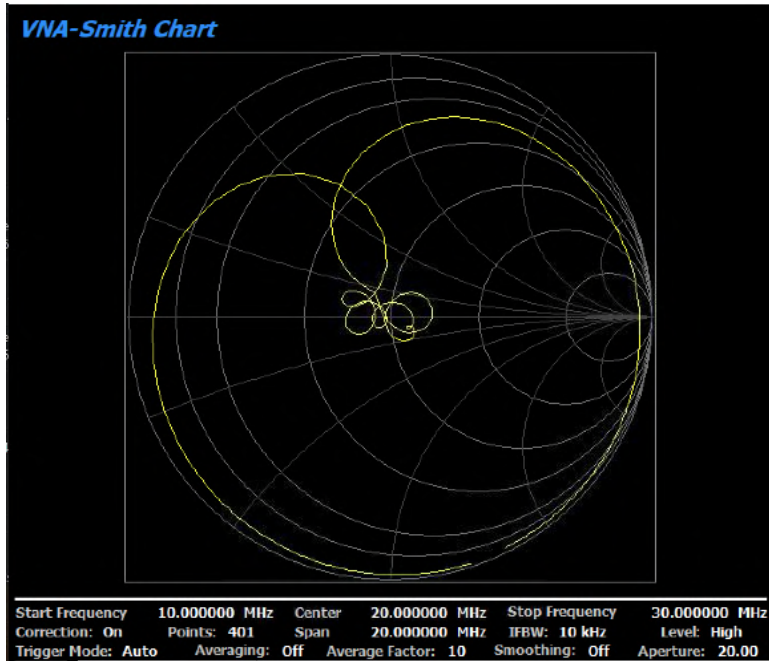

The Smith Chart displays a polar plot of the complex reflection coefficient of your device. Use the Smith Chart to determine how capacitive or inductive your device is over its designated frequency range. Enter the frequency range and power level for your device, calibrate the measurement plane, then connect the DUT. The VNA performs an S-11 measurement and presents the results in the Smith Chart display.

Important impedance measurement parameters are displayed above the status bar below the graticule. These include Start Frequency, Center Frequency (above) and Span (below), Stop Frequency, Error Correction source and status, Number of Points sampled, IFBW, Output Level, Trigger Mode, Averaging, Averaging Factor, Smoothing, and Smoothing Aperture.

See **"Measuring Normalized Impedance" on page 135** for step-by-step measurement instructions.

Calibrating the VNA

Measurement calibration characterizes the cables, adapters, and test fixtures over the same specified range of frequencies at the specified power level of the subsequent device measurement. The point in the signal path where the Device Under Test (DUT) receives the measurement stimulus from the VNA is known as the *reference plane* or the *plane of reference*. Optimally, this would be the VNA port on the front panel of the R8200. But in typical applications, other structures such as adapters, transmission lines, or test fixtures are necessary to connect the VNA to the DUT. In this case, the plane of measurement is no longer located at the VNA port, but at the point in the signal path where the DUT connects to the measurement stimulus (i.e., the adapter, transmission line, or test fixture).

Measurement calibration is achieved using a calibration kit or *cal kit* containing standardized devices (a Standard Open, Standard Short, and a Standard Load). A theoretically *flat* or constant-power RF source is swept across the frequency span planned for the subsequent (post-calibration) device measurement. These device standards qualify the plane of measurement over this range of frequencies in order to characterize the impedance discontinuities introduced by any cables, adapters, or test fixtures propagating the signal to the DUT. This data (reflection coefficients or fluctuations in reflected energy across the frequency span) is stored as a *calibration data set*. This data set drives an algorithm which mathematically compensates for the aforementioned impedance discontinuities during the subsequent device measurement, thereby increasing measurement accuracy.

NOTE

Error correction is based on the transmitted power as well as the specific number of points sampled during the frequency sweep (i.e., the frequency span of the measurement), as these data points form the equivalent reflection coefficients stored in the calibration data set. Therefore, *you must configure the number of points, power level, and frequency span for your device measurement prior to performing the calibration procedure*. Furthermore, this calibration procedure should be performed prior to all critical device measurements in order to maintain the highest measurement accuracy.

To maintain the utmost measurement accuracy, calibrate your plane of measurement before attempting any device measurement using the VNA. If this is impractical, you should consider calibrating the measurement whenever a new DUT is introduced or whenever there are *changes* in:

- the frequency span, power level, or number of points in a measurement sweep
- signal path components (i.e., transmission lines, adapters, or test fixtures)
- environmental temperature or humidity

The Device Under Test (DUT)

Like all calibrations, this example calibration procedure is performed to ensure the accuracy of a subsequent device measurement. In the following Return Loss/VSWR and Distance To Fault example measurement procedures, the DUT is an *ad hoc* composite transmission line tasked with maintaining the operation of a trunked radio system base station until the damaged original 175 ft transmission line can be replaced. This ad hoc transmission line is comprised of three sections of LMR400 cable varying in length, measuring 25, 50, and 100 feet. They are connected using Type N female-to-female adapters to form a single 175-foot replacement transmission line. This transmission line connects the output of a LMR receiving antenna to the input of a multicoupler and is expected to perform over a frequency range of 1 to 2 GHz.

All example procedures in this chapter use this transmission line as the DUT. Therefore, this example calibration procedure as well as the measurement examples are tailored to it.

NOTE

A calibration procedure should always be carried out using the same number of points, power level and frequency span as the subsequent critical device measurement it is intended to calibrate.

This section offers step-by-step instructions for calibrating your plane of measurement including required equipment, test setup, and procedure.

Required Equipment

- Freedom R8200 Communications System Analyzer
- Adapter, TNC(m) to Type N(f)
- Calibration Kit, FREEDOM CKN-M-6G

Test Setup

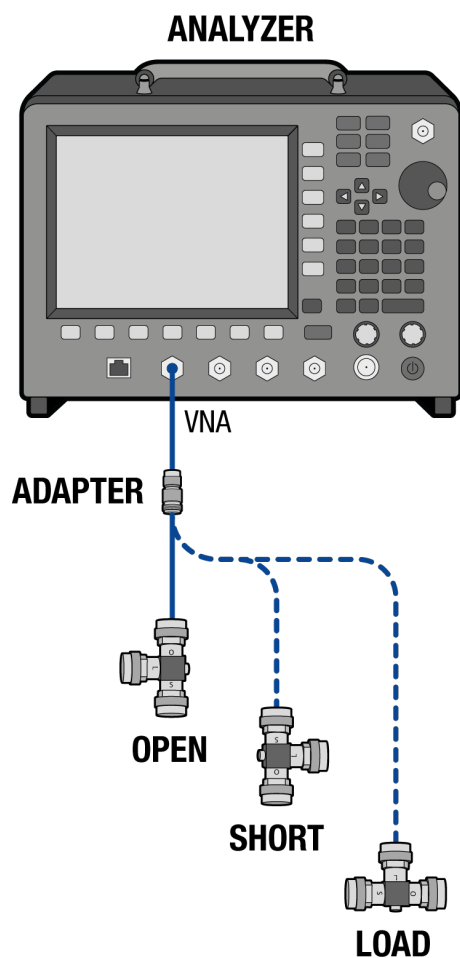

Procedure

Using the FREEDOM CKN-M-6G calibration kit, follow these steps to perform a 1-port OSL (Open, Short, Load) measurement calibration in preparation for a subsequent 1001-point device characterization from 1 GHz to 2 GHz.

Steps	Actions	Notes
1. Configure your sample points and	a. Press Select Display > Return Loss/VSWR .	This example uses a 1001 point

Steps	Actions	Notes
frequency span for your subsequent device measurement (for example " Measuring Return Loss and VSWR " on page 128).	<p>b. To set start frequency, press Frequency... > Start Frequency > 1000 > Enter.</p> <p>c. To set stop frequency, press Stop Frequency > 2000 > Enter.</p> <p>d. To set number of points in the measurement sweep, press Esc > Measure... > # of Points > 1001 > Enter.</p>	sample between 1 GHz and 2 GHz for a subsequent Return Loss measurement to create the calibration data set for error correction.
2. Select the Calibration display.	<p>a. Press Esc until you return to the main VNA menu.</p> <p>b. Press Calibration....</p>	This opens the Calibration display, which will remain open until either Apply or Esc is pressed.
3. Select the calibration kit.	<p>a. Press Calibration Kit....</p> <p>b. Use the arrow keys or the tuning knob to highlight the FREEDOM CKN-M-6G cal kit.</p> <p>c. Press Select.</p>	This opens the Calibration Kit library. It will remain open until a cal kit is selected by pressing Select , or until Esc is pressed.

Steps	Actions	Notes
		<p>The active Calibration Kit is shown above the graticule.</p>

NOTE

The next step assumes your device under test cannot be connected directly to the adapter on the VNA port due to the physical limitations of the device or the measurement environment. In this example, a short transmission line is attached to the VNA port.

Adding this transmission line results in an assembly (VNA port + adapter + transmission line). This assembly must be characterized to ensure that the calibration standard, and later the device input, is the reference plane when subsequently applying user-defined error correction generated by this calibration procedure.

4. Firmly connect the adapter to the VNA port.
 - a. Thread the adapter onto the VNA port.
 - b. Optionally, torque to 3 ft·lbf¹ with wrench. Torquing ensures consistent connections.
5. Firmly connect the adapter to the VNA port.
 - a. Remove the calibration kit from its container.

¹foot-pound force as defined by IEEE Std 260.1™-2004, IEEE Standard Letter Symbols for Units of Measurement (SI Units, Customary Inch-Pound Units, and Certain Other Units)

Steps	Actions	Notes
Standard Open and characterize the reference plane at the adapter (the subsequent point of connection of the DUT).	<ul style="list-style-type: none"> b. Attach the Standard Open to the adapter on the VNA port. c. Torque to 3 ft·lbf with wrench. d. To characterize the Standard Open, press Open. e. When the green <i>Open</i> indicator above the graticule illuminates, remove the Standard Open from the adapter. 	

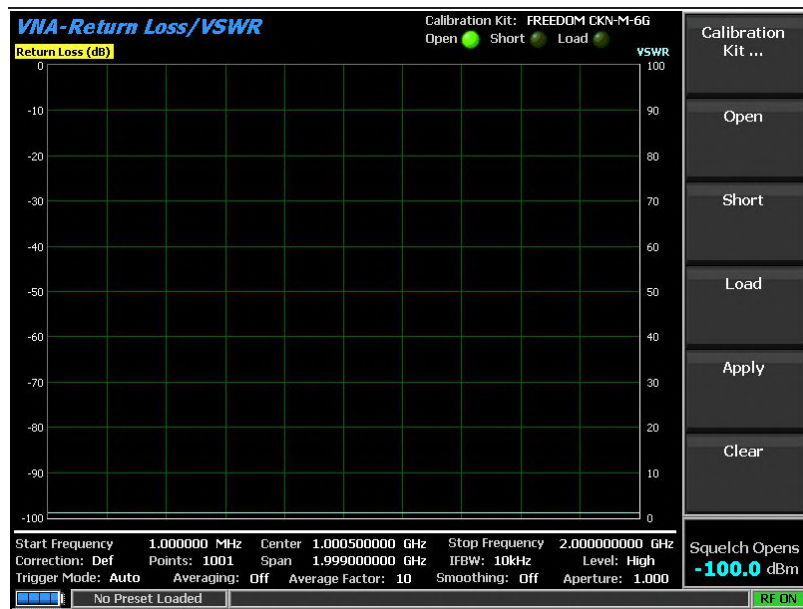

This enters one half of the data necessary to calculate phase error associated with transmission line into the calibration data set.

6. Firmly connect the Standard Short to the adapter and characterize the assembly.	<ul style="list-style-type: none"> a. Rotate the calibration kit and attach the Standard Short to the adapter on the VNA port. b. Torque to 3 ft·lbf with wrench. c. To characterize the Standard Short, press Short. d. When the green <i>Short</i> indicator 	
--	---	--

Steps	Actions	Notes
-------	---------	-------

above the graticule illuminates, remove the Standard Short from the adapter.

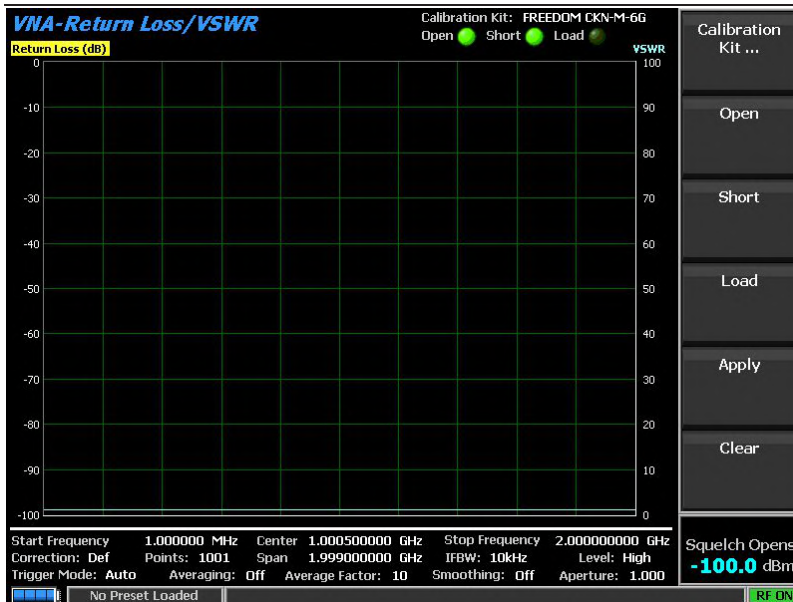

This enters the other half of the data necessary to calculate phase error associated with your transmission line into the calibration data set.

7. Firmly connect the Standard Load to the adapter and characterize the assembly.
 - a. Rotate the calibration kit and attach the Standard Load to the adapter on the VNA port.
 - b. Torque to 3 ft-lbf with wrench.
 - c. To characterize the Standard Load, press **Load**.
 - d. When the green *Load* indicator above the graticule illuminates, remove the Standard Load from the adapter.

Steps	Actions	Notes
	<p>Calibration Kit: FREEDOM CKN-M-6G Open ● Short ● Load ●</p> <p>Calibration Kit ... Open Short Load Apply Clear</p> <p>Squelch Opens -100.0 dBm</p>	<p>This enters the impedance errors associated with your adapter into the calibration data set.</p>

- | | | |
|--|--|---|
| <p>8. Apply the error correction generated by this calibration procedure to your subsequent measurement.</p> | <p>a. To apply error correction, press Apply.</p> | <p>This activates error correction and closes the Calibration display and completes the calibration procedure.</p> <p>You are now prepared to make a calibrated device measurement. For an example measurement procedure, see "Measuring Return Loss and VSWR" on page 128.</p> |
|--|--|---|

Guidelines for Recalibrating

Repeat this calibration procedure if there are *changes* in:

- The number of points in a measurement
- The frequency span or power level of a measurement
- Environmental temperature or humidity
- Any signal path component between the VNA port and the DUT

See "**Calibration Soft Keys**" on page 577 for detailed descriptions of the soft keys in this menu. Each soft key is defined, along with its range, discrete, default, and saved state values.

See "**Measuring Distance To Fault**" on page 139 for an alternative subsequent measurement procedure.

Using the Calibration Kit Library

Though the R8200 is equipped with FREEDOM CKN-M-6G calibration kit from the factory, you may use alternative calibration kits. To use an alternative calibration kit, review the Calibration Kit Library and select your preferred calibration kit. If your preferred kit is unlisted, you can add it to the Calibration Kit Library by entering the required device characteristics into the Calibration Kit Library Editor.

Selecting a Predefined Cal Kit from the Library

To select a common calibration kit from predefined models listed in the Calibration Kit Library, follow these steps.

Steps	Actions	Notes
1. Select the Calibration display to enter the Calibration Kit Library.	<p>a. From the main VNA menu, press Calibration ...</p> <p>b. Press Calibration Kit ...</p>	This opens the Calibration display, which will remain open until either Apply or Esc is pressed.
2. Highlight the stock calibration kit.	<p>a. Use the tuning knob or the arrow keys to highlight the N612-912-M calibration kit.</p> <p>b. Press Select.</p>	This selects the N612-912-M calibration kit and returns to the Calibration display.

Steps	Actions	Notes
	<p>VNA-Calibration Kit</p> <p>FREEDOM CKN-M-6G (Type-N Male 500hm 6/9GHz Cal Kit) 05CK10A-150 -F- (Type-N 500hm 18GHz Cal Kit (Rosenberger)) 05CK10A-150 -M- (Type-N 500hm 18GHz Cal Kit (Rosenberger)) N1.1 -F- (Type-N 500hm 1.5GHz Cal Kit (PLANAR)) N1.1 -M- (Type-N 500hm 1.5GHz Cal Kit (PLANAR)) 85032B/E -F- (Type-N 500hm 6GHz Cal Kit (KeySight)) 85032B/E -M- (Type-N 500hm 6GHz Cal Kit (KeySight)) 85032F -F- (Type-N 500hm 9GHz Cal Kit (Agilent)) 85032F -M- (Type-N 500hm 9GHz Cal Kit (Agilent)) N611 -F- (Type-N 500hm 6GHz Cal Kit, S/N 4xx,5xx,6xx (CMT)) N612 -M- (Type-N 500hm 6GHz Cal Kit, S/N 4xx,5xx,6xx (CMT)) 03CK10A-150 -F- (3.5 mm 26.5GHz Cal Kit (Rosenberger)) 03CK10A-150 -M- (3.5 mm 26.5GHz Cal Kit (Rosenberger)) 85033D/E -F- (3.5 mm 500hm 6GHz/9GHz Cal Kit (KeySight)) 85033D/E -M- (3.5 mm 500hm 6GHz/9GHz Cal Kit (KeySight)) N611/911 -F- (Type-N 500hm 6/9GHz Cal Kit, S/N Axx, Bxx, 12xx (CMT)) N612/912 -M- (Type-N 500hm 6/9GHz Cal Kit, S/N Axx, Bxx, 12xx (CMT)) S911 -F- (3.5 mm 500hm 9GHz Cal Kit (CMT)) S911T -F- (3.5 mm 500hm 9GHz Cal Kit (CMT)) N1801 -F- (Type-N 500hm 18GHz Cal Kit (CMT)) S2611 -F- (3.5 mm 500hm 26.5GHz Cal Kit (CMT)) N1.2 -F- (Type-N 500hm 1.5GHz Cal Kit (PLANAR)) N1.2 -M- (Type-N 500hm 1.5GHz Cal Kit (PLANAR))</p>	<p>Select</p> <p>New</p> <p>Edit</p> <p>Delete</p> <p>Squelch Opens -100.0 dBm</p> <p>RF ON</p>

3. Select the stock calibration kit. a. Press **Select**.

This selects the N612/912-M calibration kit and returns to the Calibration display.

<p>VNA-Return Loss/VSWR</p> <p>Return Loss (dB)</p> <p>Start Frequency 1.000000 MHz Center 1.000500000 GHz Stop Frequency 2.000000000 GHz Correction: Def Points: 1001 Span 1.999000000 GHz IFBW: 10kHz Level: High Trigger Mode: Auto Averaging: Off Average Factor: 10 Smoothing: Off Aperture: 1.000</p>	<p>Calibration Kit: N612/912 -M- Open Short Load</p> <p>Calibration Kit ...</p> <p>Open</p> <p>Short</p> <p>Load</p> <p>Apply</p> <p>Clear</p> <p>Squelch Opens -100.0 dBm</p> <p>RF ON</p>	<p>The active calibration kit is displayed above the graticule.</p>
--	---	---

Adding a New Cal Kit to the Calibration Kit Library

To add a new calibration kit into the R8200's Calibration Kit Library, following these steps.

Steps	Actions	Notes
1. Select the Calibration display to enter the Calibration Kit Library and open the Calibration Kit Entry Editor.	<p>a. From the main VNA menu, press Calibration ...</p> <p>b. Press Calibration Kit ...</p> <p>c. To open the Calibration Kit Entry Editor, press New.</p>	This opens the Calibration display, which will remain open until either Apply or Esc is pressed.

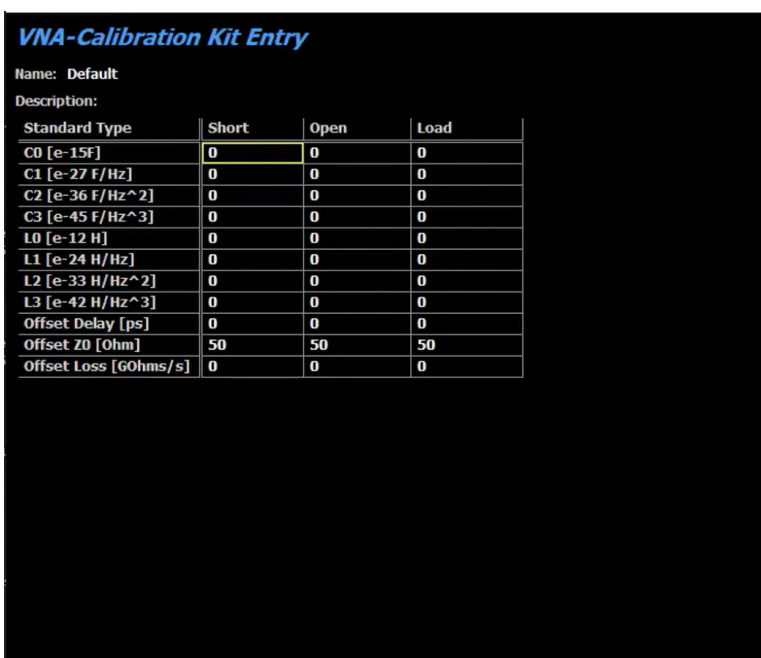

- | | | |
|--|---|---|
| 2. Describe, characterize, and save the new cal kit. | <p>a. To identify the new cal kit, press Name and use the alphanumeric keypad to enter a name.</p> <p>b. To depict the new cal kit, press Description and use the alphanumeric keypad to describe it.</p> | Value for your cal kit's open and short capacitance, inductance, offset delay, offset Z0, and offset loss can be found on the product's data sheet. |
|--|---|---|

Steps	Actions	Notes
	<ul style="list-style-type: none"> <li data-bbox="618 260 992 422">c. Use the tuning knob or the arrow keys to highlight the first field for the Standard Short (C0 [e-15F]), and press Edit Field. <li data-bbox="618 443 992 558">d. Use the alphanumeric keypad to enter the value, then press Enter. <li data-bbox="618 579 992 695">e. Repeat c and d until all cal kit parameters have been entered for the new cal kit. <li data-bbox="618 716 992 961">f. Press Save to enter the new cal kit and return to the Calibration Kit Library, or press Back to exit the Calibration Kit Entry Editor without saving the information you have entered. 	

See "[Single-Port VNA Soft Keys](#)" on page 576 for detailed descriptions of the soft keys in this menu. Each soft key is defined, along with its range, discrete, default, and saved state values.

Measuring Return Loss and VSWR

This section offers step-by-step instructions for measuring Return Loss (RL) and Voltage Standing Wave Ratio (VSWR) at 1001 points between 1 GHz and 2 GHz. The device under test in this example is an *ad hoc* transmission line. The required equipment, test setup, and procedure are included below.

NOTE

The following RL/VSWR measurement assumes the device under test (DUT) is connected through the TNC(m) to Type N(f) adapter which is connected directly to the VNA port, making the transmission line input connector the plane of reference. Calibrate the VNA to the reference plane with the calibration standards connected to the Type N(f) adapter on the VNA port to ensure the accuracy of your RL/VSWR measurement. See ["Calibrating the VNA" on page 116](#) for step-by-step instructions.

Required Equipment

- Freedom R8200 Communications System Analyzer
- Cable, LMR400, Type N(m), 100 feet
- Cable, LMR400, Type N(m), 50 feet
- Cable, LMR400, Type N(m), 25 feet
- Adapter, TNC(m) to Type N(f)
- Adapters, Type N(f) to Type N(f) (2)
- Load, 50 Ω , Type N(f)

Test Setup

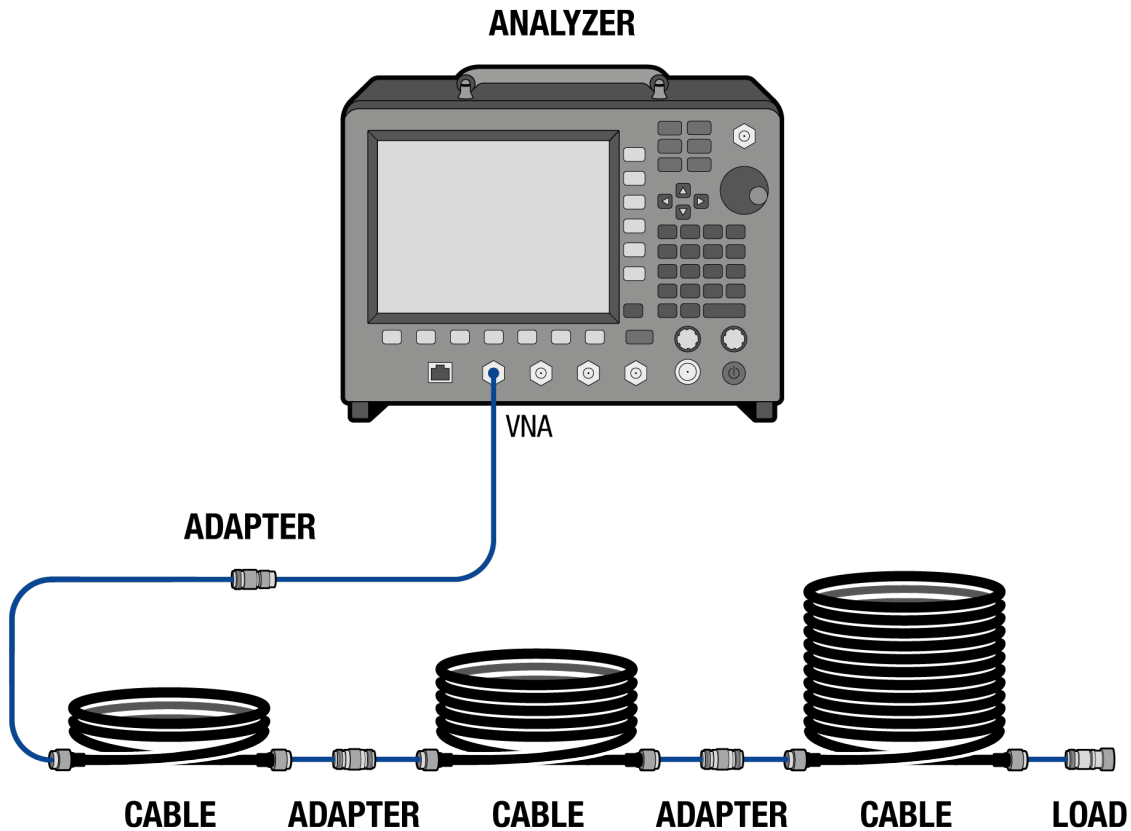

Procedure

Follow these steps to measure the RL/VSWR of the *ad hoc* transmission line at 1001 points between 1 GHz and 2 GHz.

Steps	Actions	Notes
1. Configure the R8200 to measure RL/VSWR.	a. Press Select Display > Return Loss/VSWR .	This enables the Return Loss/VSWR display.
2. Configure the RL/VSWR measurement parameters.	a. Press Frequency ... > Start Frequency > 1000 > Enter . b. Press Stop Frequency > 2000 >	Sets the frequency range of the measurement sweep from 1 to 2 GHz.

Steps	Actions	Notes
	<p>Enter.</p> <p>c. Press Esc > Measure ... > # of Points > 1001 > Enter.</p> <p>d. Press Esc to return to the top level VNA soft key menu.</p>	<p>Defines a 1001-point measurement sample over the frequency range.</p>
3. Connect the adapter to the VNA port.	<p>a. Connect the TNC(m) to Type N (f) adapter to the VNA port.</p> <p>b. Torque to 3 ft-lbf with wrench.</p>	<p>This is necessary to ensure that the calibration is performed at the reference plane (the transmission line input connector), as opposed to the VNA port.</p>
4. Calibrate the RL/VSWR measurement.	<p>a. Follow the steps outlined in "Calibrating the VNA" on page 116.</p>	<p>Measurement calibration ensures the highest accuracy analysis based on the output level and number of points sampled across the frequency range of the measurement.</p>
5. Connect and terminate the transmission line.	<p>a. Connect the TNC(m) to Type N (f) adapter on the VNA port to the transmission line input.</p> <p>b. Torque to 3 ft-lbf with wrench.</p> <p>c. Connect the 50Ω load to the transmission line output.</p> <p>d. Torque to 3 ft-lbf with wrench.</p>	
6. Scale the vertical axis of the RL display.	<p>a. From the top-level VNA soft key menu, press Scale ... > Return Loss Auto Scale.</p>	<p>Automatically scales the RL trace for an optimum view of the peaks and valleys.</p>
7. Adjust the Scale and Reference Level for both RL and VSWR to optimize the trace displays.	<p>a. Press Return Loss Scale and enter a value that produces your desired trace height.</p> <p>b. Press Return Loss Reference Value and enter a value that</p>	

Steps	Actions	Notes
	<p>moves the RL trace to the optimal position on the display.</p> <p>c. Press VSWR Scale and enter a value that produces your desired trace height.</p> <p>d. Press VSWR Reference Value and enter a value that moves the VSWR trace to the optimal position on the display.</p>	

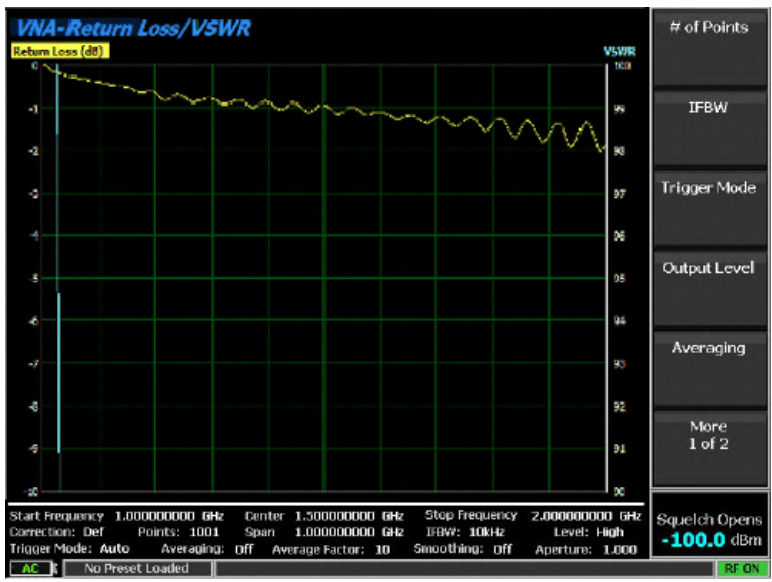

8. Enable smoothing and adjust the aperture to optimize the RL trace.
- a. Press **Esc > Measure ... > More > Smoothing > On**. Smoothing and Smoothing Aperture affects both measurement traces.
 - b. Press **Smoothing Aperture** and adjust the value to optimize the RL trace.

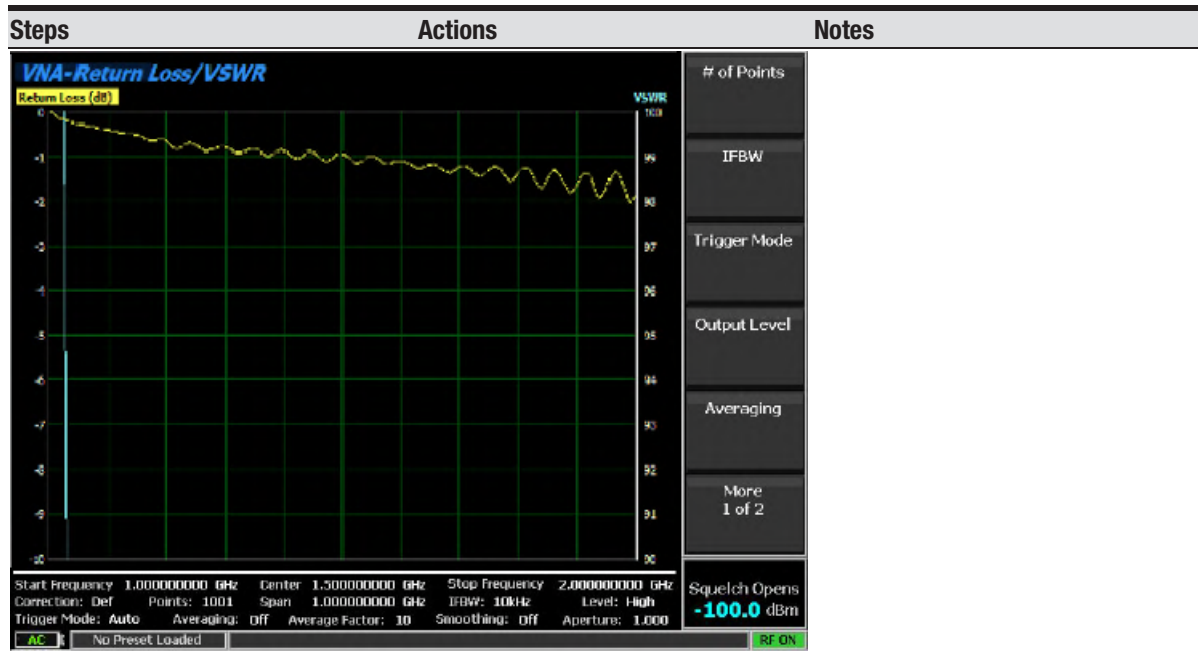

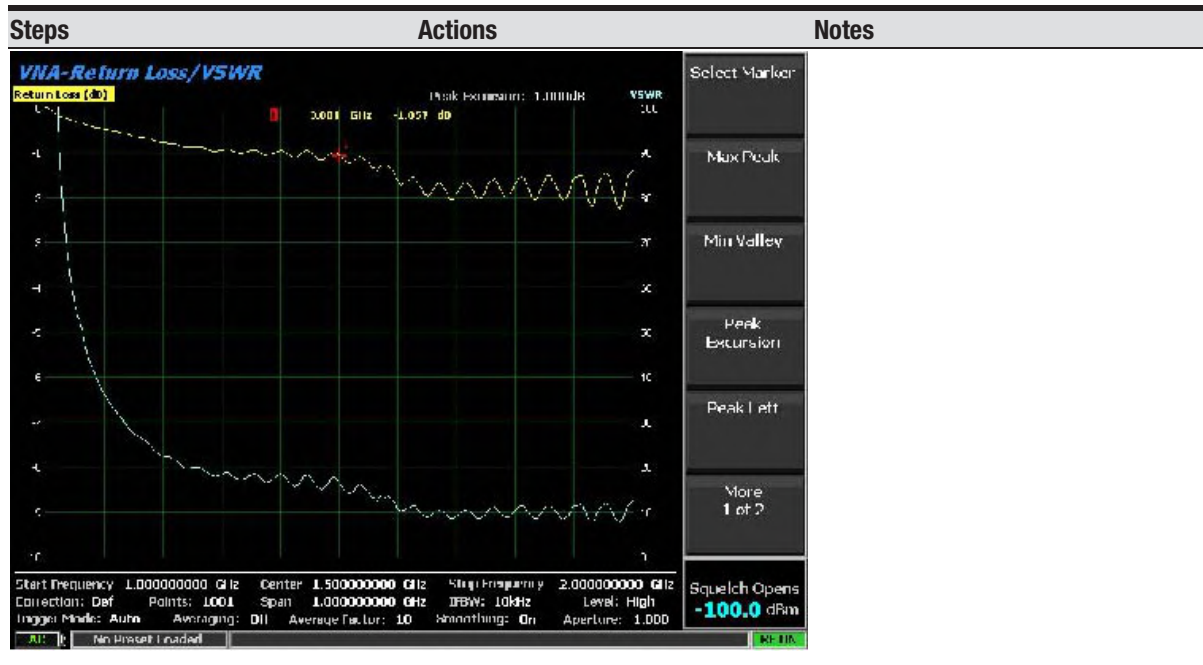

10. Document the displayed analysis of RL/VSWR.
- a. Insert a thumb drive into the USB port. This saves a screenshot of the current DISPLAY Zone to the thumb drive.
 - b. On the alphanumeric keypad, press **Shift > 1** and follow the prompts.

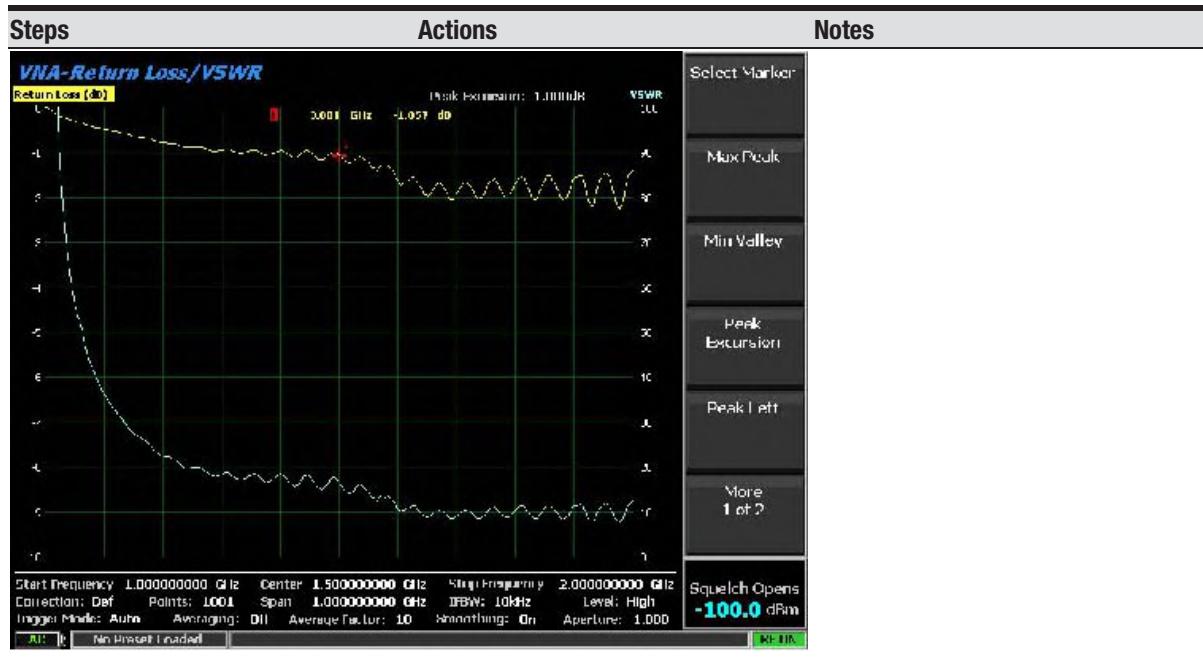

See **"Single-Port VNA Soft Keys"** on page 576 for detailed descriptions of the soft keys in this menu. Each soft key is defined, along with its range, discrete, default, and saved state values.

Measuring Normalized Impedance

This section offers step-by-step instructions for measuring Normalized Impedance (NI) at 1001 points between 10 MHz and 30 MHz. The device under test in this example is an assembly comprised of a bandpass filter centered at 20 MHz and a transmission line. The required equipment, test setup, and procedure are included below.

NOTE

The following NI measurement assumes the device under test (DUT) is connected through the TNC (m) to Type N(f) adapter which is connected directly to the VNA port, making the transmission line input connector the plane of reference. Calibrate the VNA to the reference plane with the calibration standards connected to the Type N(f) adapter on the VNA port to ensure the accuracy of your NI measurement. See ["Calibrating the VNA" on page 116](#) for step-by-step instructions.

Required Equipment

- Freedom R8200 Communications System Analyzer
- Filter, SMA(f), 20 MHz Bandpass
- Cable, coaxial, BNC(m) to SMA(m), 1 foot
- Cable, coaxial, BNC(f) to SMA(m), 1 foot
- Adapter, TNC(m) to Type N(f)
- Adapter, Type N(m) to BNC(f)
- Load, 50 Ω , BNC(m)

Test Setup

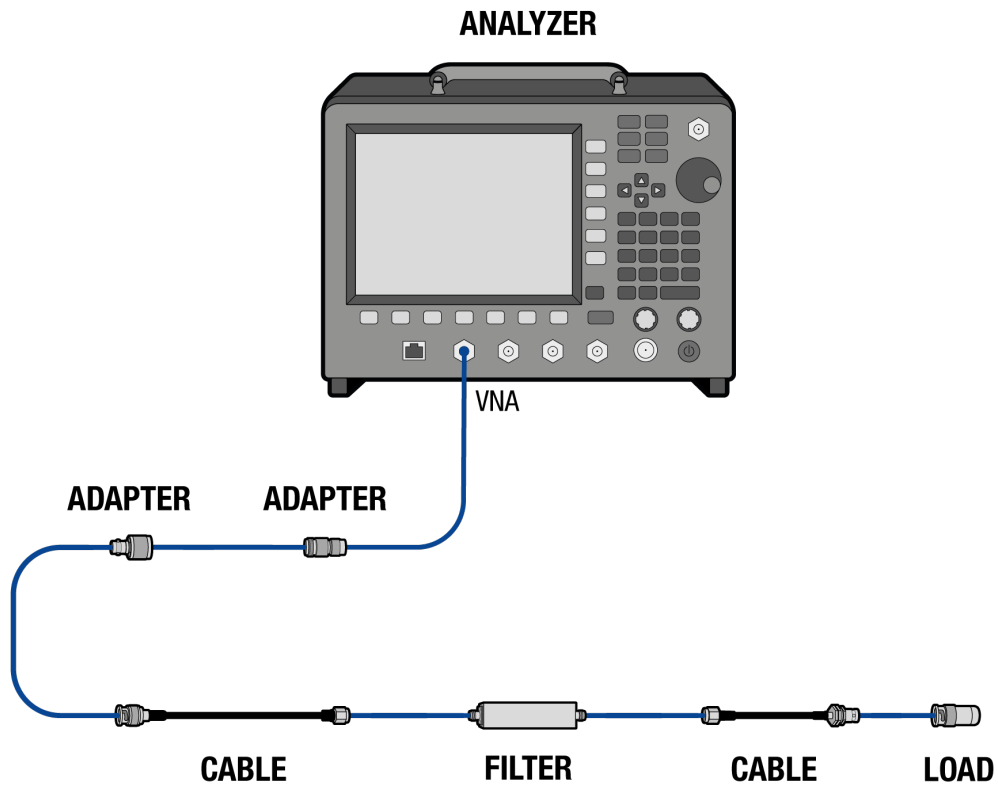

Procedure

Follow these steps to measure the NI of a bandpass filter assembly at 1001 points between 10 MHz and 30 MHz.

Steps	Actions	Notes
1. Configure the R8200 to measure NI.	a. To open the Smith Chart display, press Select Display > Smith Chart .	This enables the Smith Chart display.
2. Configure the NI measurement parameters.	a. To set the start frequency, press Frequency ... > Start Frequency > 10.000000 > Enter .	Sets the frequency range of the measurement sweep from 10 to 30 MHz.

Steps	Actions	Notes
	<p>b. To set the stop frequency, press Stop Frequency > 30.000000 > Enter.</p> <p>c. To set the number of points in the measurement sample, press Esc > Measure ... > # of Points > 1001 > Enter.</p> <p>d. To set the intermediate frequency bandwidth, press IFBW > 1 kHz > Enter.</p>	<p>Defines a 1001-point measurement sample over the frequency range.</p>
<p>3. Connect the adapter to the VNA port.</p>	<p>a. Connect the TNC(m) to Type N (f) adapter to the VNA port.</p> <p>b. Torque to 3 ft·lbf with wrench.</p>	<p>This is necessary to ensure that the calibration is performed at the reference plane (the transmission line input connector), as opposed to the VNA port.</p>
<p>4. Calibrate the NI measurement.</p>	<p>a. Follow the steps outlined in "Calibrating the VNA" on page 116.</p>	<p>Measurement calibration ensures the highest accuracy analysis based on the output level and number of points sampled across the frequency range of the measurement.</p>
<p>5. Connect the bandpass filter assembly.</p>	<p>a. Connect the TNC(m) to Type N (f) adapter on the VNA port to the Type N(m) to BNC(f) adapter.</p> <p>b. Connect the BNC(f) adapter to the BNC(m) connector on the input cable.</p> <p>c. Attach the input cable's SMA connector to the bandpass filter input.</p> <p>d. Torque to 3 ft·lbf with wrench.</p>	

Steps	Actions	Notes
	<ul style="list-style-type: none"> e. Connect the output of the band-pass filter to the output cable. f. Torque to 3 ft·lbf with wrench. g. Attach the opposite end of the output cable to the BNC 50Ω load. 	

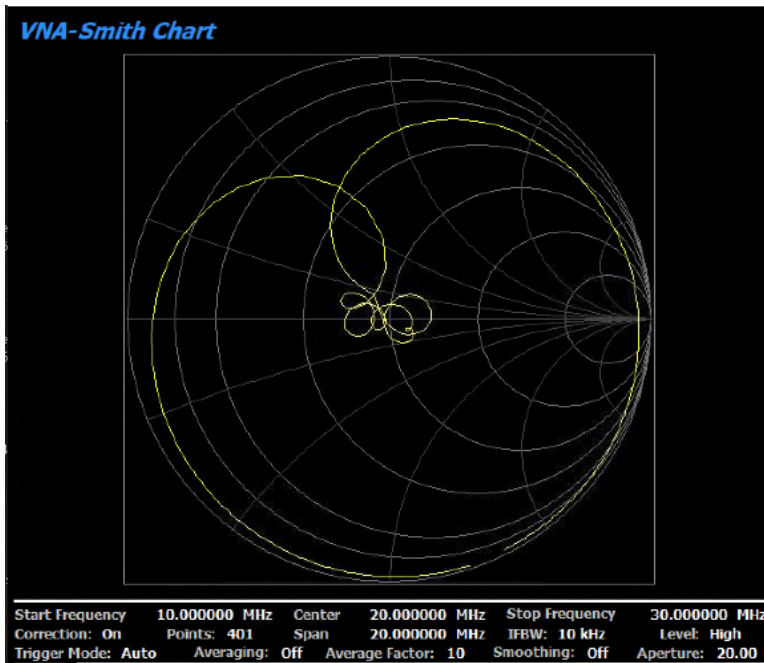

Once the circuit is closed, the VNA sweeps the frequency range to produce a measure of the bandpass filter's NI, as shown.

See **"Single-Port VNA Soft Keys"** on page 576 for detailed descriptions of the soft keys in this menu. Each soft key is defined, along with its range, discrete, default, and saved state values.

Measuring Distance To Fault

This section offers step-by-step instructions for measuring Distance to Fault at 1001 points between 1 GHz and 2 GHz. The device under test is an *ad hoc* transmission line. The required equipment, test setup, and procedure are included below.

NOTE

The following Distance To Fault measurement assumes the device under test is connected through the TNC(m) to Type N(f) adapter which is connected directly to the VNA port, making the transmission line input connector the plane of reference. Calibrate the VNA to the reference plane with the calibration standards connected to the Type N(f) connector on the adapter to ensure the accuracy of your Distance To Fault measurement. See ["Calibrating the VNA" on page 116](#) for step-by-step instructions.

Required Equipment

- Freedom R8200 Communications System Analyzer
- Cable, LMR400, Type N(m), 100 feet
- Cable, LMR400, Type N(m), 50 feet
- Cable, LMR400, Type N(m), 25 feet
- Adapter, TNC(m) to Type N(f)
- Adapters, Type N(f) to Type N(f) (2)

Test Setup

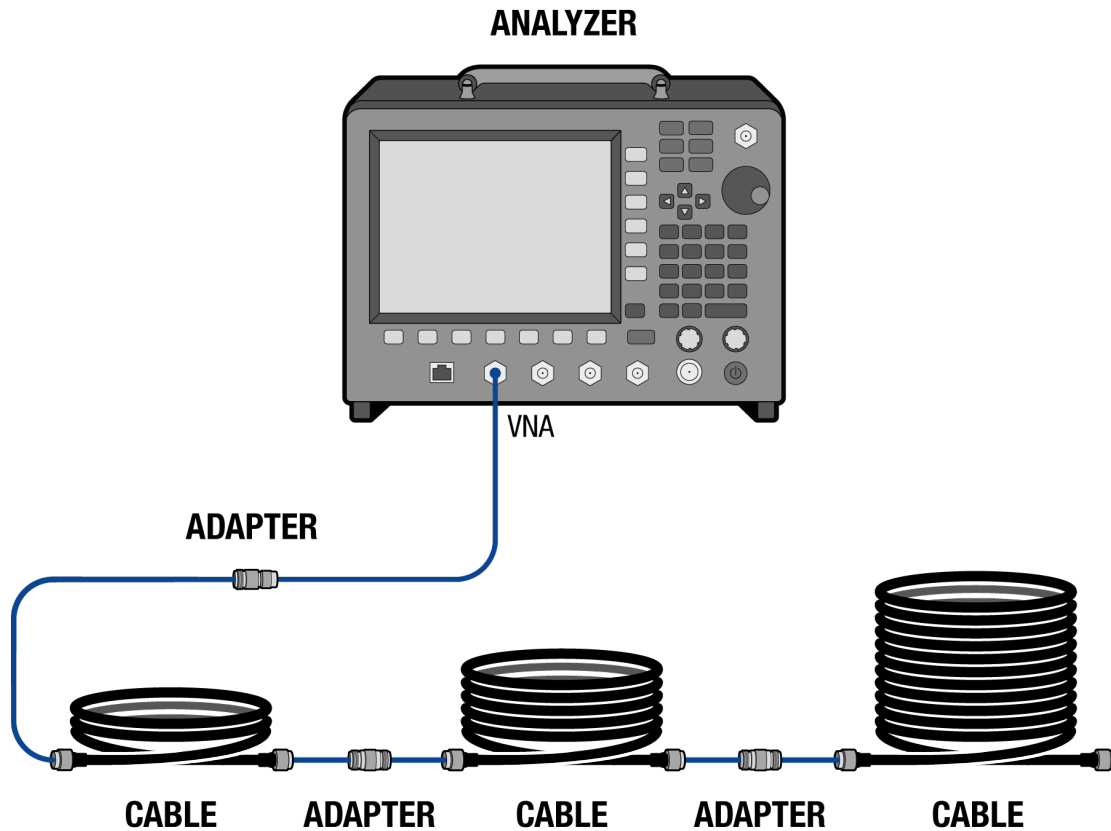

Procedure

Follow these steps to measure Distance To Fault for an ad hoc transmission line.

Steps	Actions	Notes
1. Configure the R8200 to measure Distance To Fault.	<p>a. Press Instrument > More 1 of 2 > Single-Port VNA.</p> <p>b. Press Select Display > Distance To Fault.</p>	This enables the Distance To Fault display.

Steps	Actions	Notes
2. Define the DTF measurement parameters.	a. To define the distance units, press Distance ... > Distance Units > ft > Enter.	Sets the distance units to feet.
	b. To define the length of the transmission line, press Maximum Length > 200 > Enter.	Maximum Length defines the length of the measurement.
	c. To define the size of the measurement sample, press Esc > Measure ... > # of Points > 1001 > Enter.	Number of points defines how many RL/distance data points are sampled for calibration and measurement.
	d. To instantiate the velocity factor and frequency response of the DUT, press Esc > More 1 of 2 > Cable List	
	e. Use the arrow keys or the knob to highlight LMR400 and press Select.	
3. Define the DTF display parameters.	a. To define the trace display type, press Measure ...> Response Type > Lowpass Impulse.	
	b. To define the position of the beginning of the display trace, press Esc > Distance ... > Start Distance > 0 > Enter.	Start and stop distance define the span of the display.
	c. To define the position of the end of the display trace, press Stop Distance > 200 > Enter.	
4. Connect the adapter to the VNA port.	a. Connect the TNC(m) to Type N (f) adapter to the VNA port.	This is necessary to ensure that the calibration is performed at the reference plane (the transmission line input connector), as opposed to the
	b. Torque to 3 ft-lbf with wrench.	

Steps	Actions	Notes
5. Calibrate the DTF measurement.	<ul style="list-style-type: none"> a. Follow the steps outlined in "Calibrating the VNA" on page 116. 	<p>VNA port.</p> <p>Measurement calibration ensures the highest accuracy analysis based on the cable type, maximum length, output level and number of points sampled across the frequency range of the measurement.</p>
6. Add Smoothing, Smoothing Aperture, Scalings, and Markers.	<ul style="list-style-type: none"> a. To smooth the trace, press Measure ... > More 1 of 2 > Smoothing > On > Enter. b. To alter the extent of smoothing, press Smoothing Aperture. c. To scale the DTF trace, press Esc > Scale ... > Auto Scale. d. To place markers at the discontinuities, press Esc > More 1 of 2 > Marker ... > Marker Mode > Absolute. 	

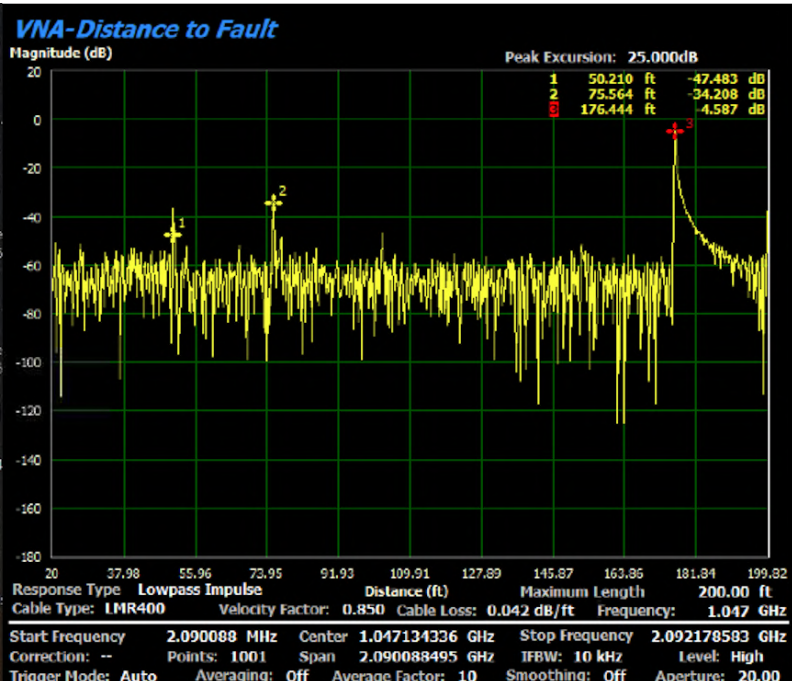
Steps	Actions	Notes									
	 <p>VNA-Distance to Fault Peak Excursion: 25.000dB</p> <table border="1"> <tr> <td>1</td> <td>50.210 ft</td> <td>-47.483 dB</td> </tr> <tr> <td>2</td> <td>75.564 ft</td> <td>-24.208 dB</td> </tr> <tr> <td>3</td> <td>176.444 ft</td> <td>-4.587 dB</td> </tr> </table> <p>Response Type: Lowpass Impulse Cable Type: LMR400 Velocity Factor: 0.850 Cable Loss: 0.042 dB/ft Frequency: 1.047 GHz Start Frequency: 2.090088 MHz Center: 1.047134336 GHz Stop Frequency: 2.092178583 GHz Correction: -- Points: 1001 Span: 2.090088495 GHz IFBW: 10 kHz Level: High Trigger Mode: Auto Averaging: Off Average Factor: 10 Smoothing: Off Aperture: 20.00</p>	1	50.210 ft	-47.483 dB	2	75.564 ft	-24.208 dB	3	176.444 ft	-4.587 dB	<p>Your display should look similar to the measurement shown here.</p>
1	50.210 ft	-47.483 dB									
2	75.564 ft	-24.208 dB									
3	176.444 ft	-4.587 dB									

See "[Single-Port VNA Soft Keys](#)" on page 576 for detailed descriptions of the soft keys in this menu. Each soft key is defined, along with its range, discrete, default, and saved state values.

Using the Cable List

In many working environments, a direct connection between the R8200 and the DUT is impractical or impossible. In these situations, it may be necessary to use an available cable as an intermediary transmission line between the VNA and the DUT. The R8200 comes equipped with a predefined Cable List that contains descriptions and critical physical characteristics (velocity factor, dB-per-foot-loss at three frequencies) for an array of common RF cable types. This enables you to connect your DUT to the VNA using a variety of common cable types without forfeiting measurement accuracy due to the use of an uncharacterized transmission line between the VNA and the DUT when performing Distance to Fault measurements with the R8200.

Selecting a Cable from the Cable List

To select an LMR400 cable from the R8200's Cable List, follow these steps.

Steps	Actions	Notes
1. Open the Cable List.	a. To open the Cable List from the Distance To Fault display, press More > Cable List ...	Alternatively, to open the Cable List from the default factory configuration, press Instrument > More > Single-Port VNA > Select Display > Distance To Fault > More > Cable List.
2. Locate the LMR400 cable.	a. Use the tuning knob or the arrow keys to locate and highlight the LMR400 cable in the Cable List.	

Steps	Actions	Notes
-------	---------	-------

VNA-Cable List

Description	Vel Factor	CL1 (dB/ft)	F1 (MHz)	CL2 (dB/ft)	F2 (MHz)	CL3 (dB/ft)	F3 (MHz)
RF 5/8"-50 GHF"	0.88	0.0158	1000	0.0234	2000	0.0265	2500
RF 5/8"-50 BHF"	0.88	0.0158	1000	0.0234	2000	0.0265	2500
RF 7/8"-50	0.88	0.0126	1000	0.0189	2000	0.0213	2500
RF 7/8"-50 GHF"	0.88	0.0126	1000	0.0189	2000	0.0213	2500
RF 7/8"-50 BHF"	0.88	0.0126	1000	0.0189	2000	0.0213	2500
RF 1 5/8"-50	0.88	0.0076	1000	0.0116	2000	0.0134	2500
RF 1 5/8"-50 GHF"	0.88	0.0076	1000	0.0116	2000	0.0134	2500
RF 1 5/8"-50 BHF"	0.88	0.0076	1000	0.0116	2000	0.0134	2500
RF 2 1/4"-50	0.88	0.0064	1000	0.0104	2000	0.0104	2000
RF 2 1/4"-50 GHF	0.88	0.0064	1000	0.0104	2000	0.0104	2000
RF 2 1/4"-50 BHF	0.88	0.0064	1000	0.0104	2000	0.0104	2000
RFF 3/8"-50	0.81	0.0448	1000	0.0664	2000	0.0762	2500
RFF 3/8"-50 GHF	0.81	0.0448	1000	0.0664	2000	0.0762	2500
RFF 3/8"-50 BHF	0.81	0.0448	1000	0.0664	2000	0.0762	2500
RFF 1/2"-50	0.82	0.0341	1000	0.0509	2000	0.0579	2500
RFF 1/2"-50 GHF	0.82	0.0341	1000	0.0509	2000	0.0579	2500
RFF 1/2"-50 BHF	0.82	0.0341	1000	0.0509	2000	0.0579	2500
RFF 7/8"-50	0.84	0.0158	1000	0.0238	2000	0.0271	2500
RFF 7/8"-50 GHF	0.84	0.0158	1000	0.0238	2000	0.0271	2500
RFF 7/8"-50 BHF	0.84	0.0158	1000	0.0238	2000	0.0271	2500
LMR100	0.8	0.2414	1000	0.3505	2000	0.3993	2500
LMR200	0.83	0.1049	1000	0.1494	2000	0.1689	2500
LMR240	0.84	0.0799	1000	0.1149	2000	0.1292	2500
LMR400	0.85	0.0411	1000	0.0597	2000	0.0677	2500
LMR500	0.86	0.0332	1000	0.0485	2000	0.0549	2500
LMR600	0.87	0.0265	1000	0.039	2000	0.0442	2500
LMR900	0.87	0.0171	1000	0.0262	2000	0.0299	2500
LMR1200	0.88	0.0134	1000	0.0198	2000	0.0226	2500
LMR1700	0.89	0.0101	1000	0.0149	2000	0.0171	2500
310801	0.821	0.0351	1000	0.0351	1000	0.0351	1000

3. Select the LMR400 cable.
 - a. Press **Select**.

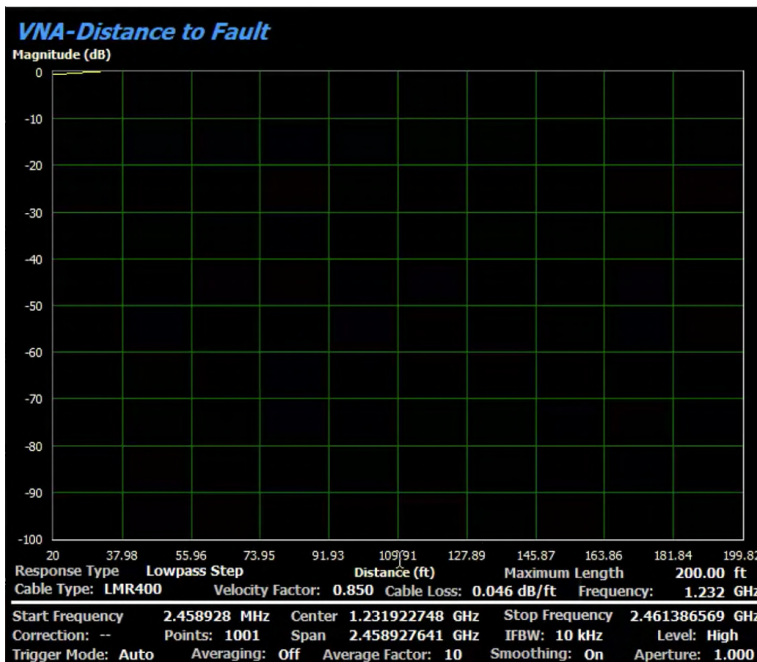

The current Cable Type is displayed below Response Type below the Distance To Fault graticule.

See **"Single-Port VNA Soft Keys" on page 576** for detailed descriptions of the soft keys in this menu. Each soft key is defined, along with its range, discrete, default, and saved state values.

6 Using Test Mode

This chapter contains step-by-step instructions for utilizing the analyzer's Test Mode. This mode offers access to the R8200's Preset menu where you can save and recall global instrument configurations, as well as submenus for configuring optional advanced radio protocols using digital modulation such as DMR, P25, NXDN, dPMR and TETRA. Test Mode also offers AutoTune and AutoScript which enable the test and alignment of a variety of radio makes and models (AutoTune), as well as scripted control and monitoring of the R8200 (AutoScript), eliminating the need for an external computer to manage complex verification procedures. Each section includes an overview with a detailed description of the display user interface, as well as step-by-step instructions for using each feature.

"Introducing Presets" on page 149 and **"Using Presets" on page 150** explains how to store, recall, import, export and delete complex instrument configurations.

"Introducing DMR Test Mode" on page 152 explains how to use DMR Test Mode, including an overview of the DMR Zone, as well as **"Using DMR Test Mode" on page 163**.

"Introducing PROJECT 25 Test Mode" on page 168 explains how to use PROJECT 25 Test Mode, including an overview of the PROJECT 25 Zone, as well as **"Using PROJECT 25 Test Mode" on page 183**.

"Introducing P25 Trunk Mode" on page 188 explains how to use the P25 Trunk Test Mode, including an overview of the P25 Trunk Zone, as well as its RF, DISPLAY, and METER Zones.

"Introducing NXDN™ Test Mode" on page 196 explains how to use the NXDN™ Test Mode, including an overview of the NXDN™ Zone, as well as **"Using NXDN™ Test Mode" on page 203**.

"Introducing NXDN™ Trunk Mode" on page 208 explains how to use the NXDN™ Trunk Test Mode, including an overview of the NXDN™ Zone, as well as **"Using NXDN™ Trunk Test Mode" on page 215**.

"Introducing TETRA Base Station Test Mode" on page 220 includes an overview of the TETRA Base Station Zone, as well as **"Using TETRA Base Station Test Mode" on page 236**.

"Introducing TETRA DMO Test Mode" on page 243 includes an overview of the TETRA DMO Zone, as well as **"Using TETRA DMO Test Mode" on page 253**.

"Introducing TETRA TMO Test Mode" on page 258 explains how to use the TETRA TMO Test Mode, including an overview of the TETRA TMO Zone, as well as **"Using TETRA TMO Test Mode" on page 273**.

"Introducing dPMR Test Mode" on page 278 explains how to use the dPMR Test Mode, including an overview of the dPMR Zone, as well as **"Using dPMR Test Mode" on page 285**.

"Introducing P25 Phase 2 Mode" on page 290 includes an overview of the P25 II Zone as well as its RF, DISPLAY, and METER Zones.

"Introducing PTC-ITCR Mode" on page 298 explains how to use the PTC-ITCR Test Mode, including an overview of the PTC-ITCR Zone and **"Using PTC-ITCR Test Mode" on page 305**.

"Introducing PTC-ACSES Test Mode" on page 308 explains how to use the PTC-ACSES Test Mode, including an overview of the PTC-ACSES Zone and **"Using PTC-ACSES Test Mode" on page 317**.

"Introducing AutoTune" on page 321 explains how to use AutoTune, including an overview of the AutoTune display, as well as **"Using AutoTune" on page 323**.

"Introducing AutoScript" on page 325 explains how to use AutoScript, including an overview of the AutoScript display, as well as **"Using AutoScript" on page 337**.

Introducing Presets

Presets are a convenient tool for storing and recalling R8200 operational configurations and parameter settings. The Presets menu enables storing, loading, sharing and deletion of user-defined configurations as well as quickly returning the analyzer to its factory default configuration. They are especially useful when several unique or complex operating configurations are repeatedly required in a test environment.

Presets ensure a fast and accurate method of configuring the analyzer for multiple test applications. To save time and avoid errors, the R8200 can store over 100 preset operating configurations. The Presets menu can display up to 47 characters, allowing you to describe the configuration in great detail. Presets can be shared between analyzers by exporting them to a thumb drive and importing them on an alternate analyzer, allowing you to quickly configure a new or replacement instrument for a specific set of verification and maintenance tasks. The Presets display with its top level soft key menu is shown below.

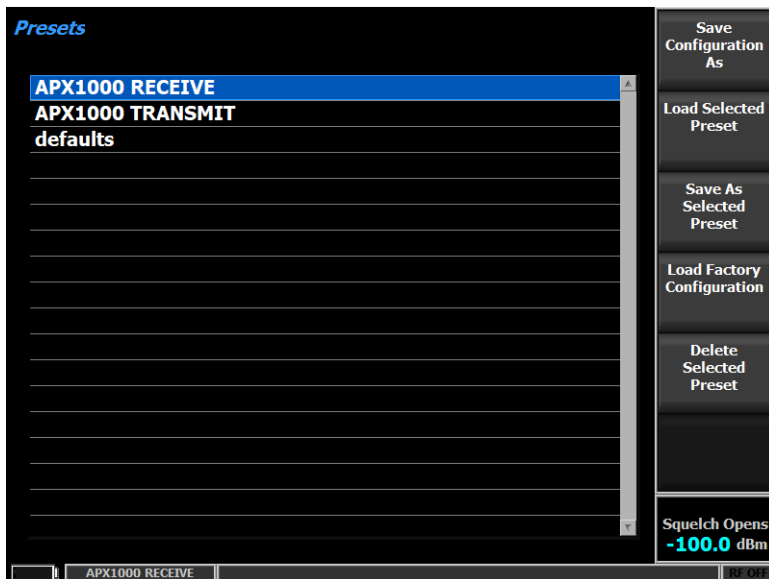

If no presets are present, the R8200 powers up in the default factory configuration. Otherwise, the analyzer powers up according to the last Preset loaded or saved before the unit was powered down.

For Preset soft key definitions, ranges, discrete and default values, and detailed notes, see ["Presets Soft Keys" on page 593](#).

To learn how to use Presets, ["Using Presets" on the next page](#).

Using Presets

The Presets menu enables storing, loading, importing, exporting, and deletion of custom communication systems analyzer configurations as well as loading the R8200 factory default configuration. To store, load, import, export, and delete global analyzer configurations, as well as return the analyzer to its factory default configuration, follow the steps below.

NOTE

A thumb drive must be inserted into the R8200 USB connector in order to display the **Export Presets** key. A Preset configuration must be saved to the thumb drive in order to display the **Import Presets** soft key.

For Preset soft key definitions, ranges, discrete and default values, and detailed notes, see "[Presets Soft Keys](#)" on page 593.

Steps	Actions	Notes
1. Save your current configuration as a Preset.	<p>a. Press Test > Preset</p> <p>b. Press Save Configuration As.</p> <p>c. Use the arrow keys and the alpha-numeric keypad to enter name (up to a 47 characters) for your Preset.</p> <p>d. Press Enter.</p>	
2. Load a Preset to configure a measurement or stimulus.	<p>a. Press Test > Preset</p> <p>b. Use the arrow keys to highlight the desired Preset.</p> <p>c. Press Enter.</p>	
3. Export a Preset to an external thumb drive.	<p>a. Insert a thumb drive into a USB connector on the R8200.</p> <p>b. Press Test > Preset</p> <p>c. Press Export Presets.</p> <p>d. Use the arrow keys or the tuning</p>	

Steps	Actions	Notes
	knob to select the desired Preset for export. e. Press Enter.	
4. Delete a Preset.	a. Press Test > Preset b. Select the Preset that you just exported to the thumb drive. c. Press More > Delete Selected Preset. d. Press Continue.	
5. Import a Preset from an external thumb drive.	a. Press Test > Preset b. Press Import Presets. c. Select the Preset that you want to import from the thumb drive. d. Press Enter.	
6. Load the analyzer factory default configuration.	a. Press Test > Preset b. Press More > Load Factory Configuration.	

See "**Presets Soft Keys**" on page 593 for detailed descriptions of the soft keys in this menu. Each soft key is defined, along with its range, discrete, default, and saved state values.

Introducing DMR Test Mode

The R8200 DMR Test Package option DMR Test Mode allows testing of repeater/subscriber radios compliant with the ETSI Digital Mobile Radio (DMR) Tier 2 conventional (non-trunked) radio transmission protocol. The DMR Test mode also supports recovery of Network ID information of a DMR Tier III Base Station. DMR radios use a digital transmission format employing Four-Level Frequency Shift Keying (4FSK) modulation with Time Division Multiple Access (TDMA) channeling with two timeslots per frame.

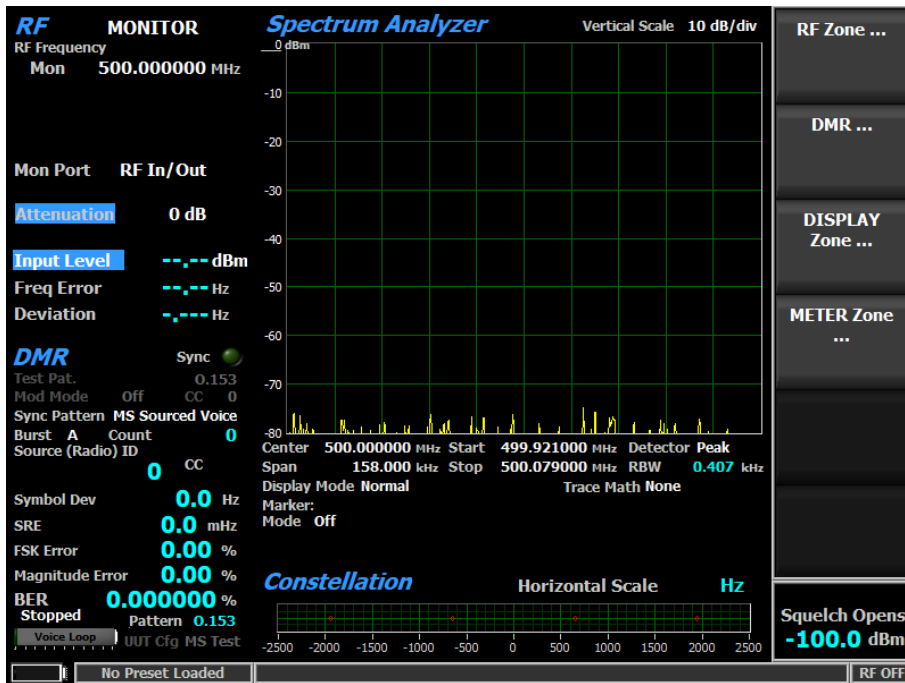

Pressing **Test > Test Mode > DMR** configures the R8200 for DMR protocol testing, as shown above. The default mode's AUDIO Zone and associated soft keys on the R8200 display are replaced by the DMR Zone and DMR-specific soft keys (accessed by pressing the **DMR** soft key).

NOTE

The manufacturer's Radio Service Software (RSS), Motorola MOTOTRBO™ Radio Tuner software, is required to perform some tests in DMR Test mode because certain measurements (BER) require placing the radio in a special test mode. The Tuner software places the radio in specific test modes, while the role of the R8200 service monitor is to transmit and receive

test patterns compliant with the DMR physical layer. Tests that do not require RSS include Subscriber Slot Power, Frequency Error, Symbol Deviation, FSK Error, Magnitude Error, Power Profile, and Constellation. Averaging can be applied to some measurements by configuring it in the System Settings.

The RF Zone

The RF Zone during DMR transmitter testing (with the R8200 in Monitor Mode) is shown on the left while the RF Zone during DMR receiver testing (with the R8200 in Generate Mode or Duplex Mode) is shown in the center and on the right, below.

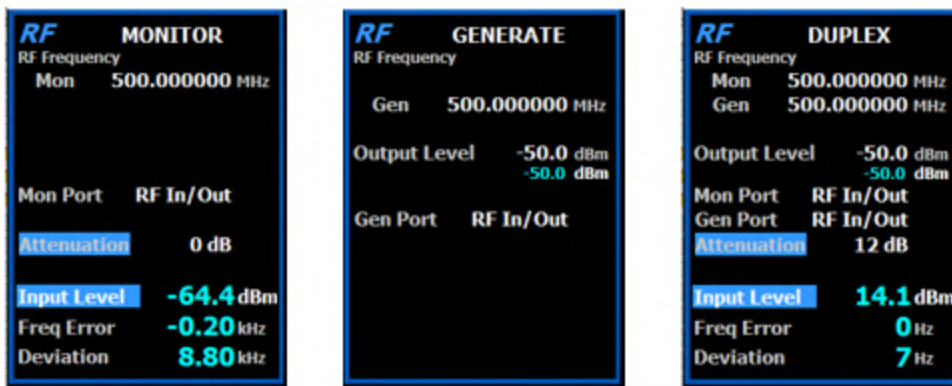

In DMR Test Mode, the RF Zone displays parameters associated with the DMR carrier generated by the R8200 as well as RF measurements of the radio transmissions. During DMR Test Mode, the RF Zone offers the following measurement displays:

Input Level – Displays the average power in the specified Burst of the synchronized TDMA slot of the received signal.

NOTE

Although Input Level is used for Squelch, Squelch has no effect on measurement updates.

When the RF input power on the RF In/Out port is above +20 dBm (100 mW), the R8200 utilizes a broadband power detector for the measurement. The Input Level field in the RF Zone changes to Watt Meter to indicate this measurement mode. For best accuracy, disable the Pre-amplifier in Monitor Mode and set the Gen Port in Generate Mode to RF In/Out.

The TDMA transmission alternates between a used and unused time slot, so the RF Zone field will switch between the two. An unused slot has no power, so the display will flash between Input Level and Watt Meter. In this condition the Input Level reading should be used since null slots can cause the Watt Meter indication to read approximately 3 dB less than the power in the used slots. The Input Source parameter can be used to force narrow or broadband power. That is useful for TDMA protocols whose on and off slots can cause the indicator to toggle between them.

Watt Meter – Displays the level of broadband power applied to the RF In/Out port when the RF input power on the RF In/Out port is above +20 dBm (100 mW).

Freq Error – Displays the difference between the received DMR carrier frequency and the R8200 Monitor Frequency.

Deviation – Displays the negative and positive peak frequency deviation of a modulated carrier (i.e., from the Frequency Error mean), available when Modulation Mode is FM.

While the analyzer is operating in DMR Test Mode, the RF Zone soft key menus contain all of the parameter settings for the controlling the R8200 RF output. For a complete soft key reference for the RF Zone, see "[RF Zone Soft Keys for Duplex Mode](#)" on page 462.

The DMR Zone

While operating in DMR Test Mode, the AUDIO Zone and associated soft keys are replaced by the DMR Zone and DMR-specific soft keys. The DMR Zone displays the physical layer parameters that can be configured to encode and decode DMR content. The DMR Zone is shown in Monitor Mode on the left, Generate Mode in the middle, and Duplex Mode on the right, below.

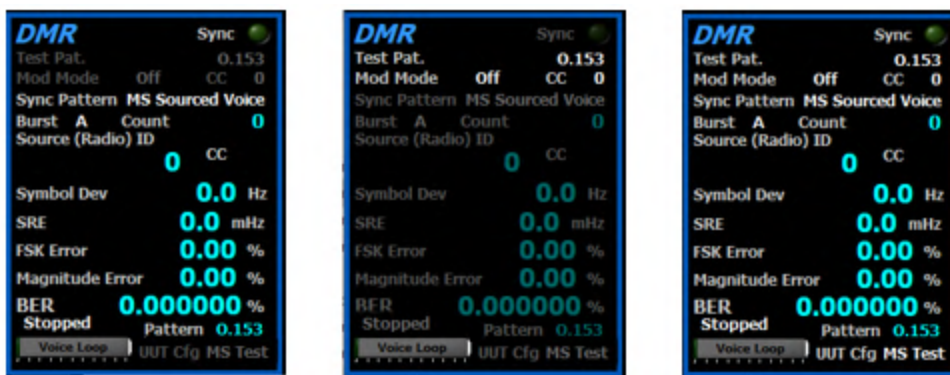

The DMR Zone offers the following measurement displays:

Count – Displays increments each time the specified SYNC Pattern is detected; thus, the R8200 synchronizes to that TDMA slot. The green Sync indicator also illuminates.

NOTE

Test measurements are only displayed if two consecutive SYNC patterns are detected; this maximizes the accuracy of the measurement.

Source (Radio) ID – Displays the Source Identifier (ID), which identifies the individual address of the transmitter. This is obtained from bytes 7–9 of the Full Link Control message composed by four 32-bit embedded signaling fields at the center of bursts B to F of a voice super frame. The Source ID is displayed in base 10 and base 16 format.

CC – Displays the four-bit color code (0 to 15) of the synchronized TDMA slot of the received signal transmission. CC is digital ID information equivalent to CTCSS/PL and CDCSS/DPL of analog FM radio systems.

Symbol Dev – Displays the symbol deviation estimated by averaging the normalized frequency deviations at symbol times in the specified burst of the synchronized TDMA slot of the received signal and then scaling by the maximum symbol value. The normalized frequency deviation is computed as the ratio of the actual frequency measurement at a given symbol or deviation state by the corresponding symbol value. The target frequency deviations representing the four symbols are listed below.

Bit 1	Bit 0	Symbol	Carrier Frequency Deviation
0	1	+3	+1944 Hz
0	0	+1	+648 Hz
1	0	-1	-648 Hz
1	1	-3	-1944 Hz

SRE – Displays the Symbol Rate Error (SRE; in milliHertz). SRE is a measurement of transmitter symbol rate accuracy, the difference of the actual minus the ideal. Thus, a positive error indicates that the transmitter clock is too fast.

FSK Error – Displays the percentage computed from the symbols in the specified Burst of the synchronized TDMA slot of the received signal. The FSK Error is computed relative to the Symbol Deviation measurement.

Magnitude Error – Displays the percentage computed from the symbols in the specified Burst of the synchronized TDMA slot of the received signal.

BER – Displays the bit error rate percentage of bit differences between the 0.153 pattern and the bits of the synchronized TDMA slot of the received signal. For example, if 13 of the 1296 super frame payload bits do not match the predefined pattern, the rate will be 1.0030864% (13/1296×100%). Assurance of the computation may be gained by transmitting a different calibration test pattern (e.g., BER of 1031 Hz vs. 0.153 is 47.299381%).

While the analyzer is operating in DMR Test Mode, the DMR Zone soft key menus contain all of the R8200 parameter settings for the controlling the DMR physical layer. For a complete soft key reference for the DMR Zone, see **"DMR Zone Soft Keys"** on page 597.

The DISPLAY Zone

During DMR Test Mode, the DISPLAY Zone offers a Spectrum Analyzer, Eye Diagram, Power Profile, Distribution Plot, and tables of analysis and protocol details, accessed by pressing **Select Display**, as shown in the horizontal soft key menu below.

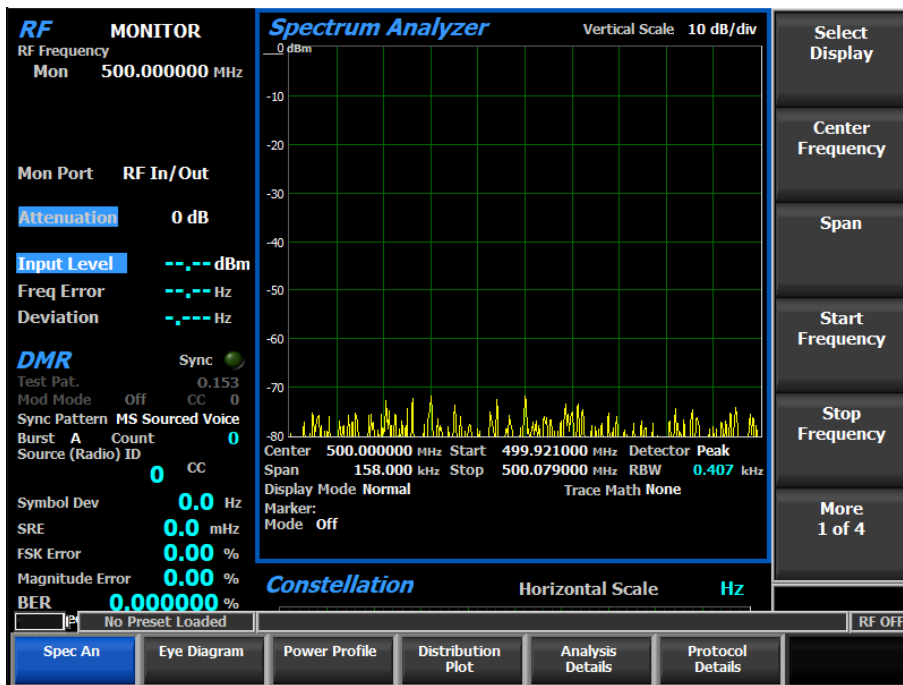

Spectrum Analyzer

In various digital protocol Test Modes, access to the Spectrum Analyzer is offered via the DISPLAY Zone. For an overview of its functionality, see ["Introducing the Spectrum Analyzer" on page 93](#). For a detailed reference of its parameter settings, see ["Spectrum Analyzer Soft Keys" on page 525](#).

Eye Diagram

In various digital protocol Test Modes, access to the Eye Diagram is offered via the DISPLAY Zone. This specialized configuration of the Oscilloscope provides a visual display of the received digital modulation signal and overlays the modulation response during two symbol periods over the four target crossing points of an ideal signals, as shown on the left below. The diagram indicates whether a transmitter has significant unbalances or offsets in the modulation circuitry by noting how tightly grouped the waveform is around the crossing points. Be sure that the Monitor Modulation Type in the digital Test Mode Zone is set for the expected transmitted digital modulation signal in order to establish the appropriate symbol timing used to position the diagram on the horizontal axis.

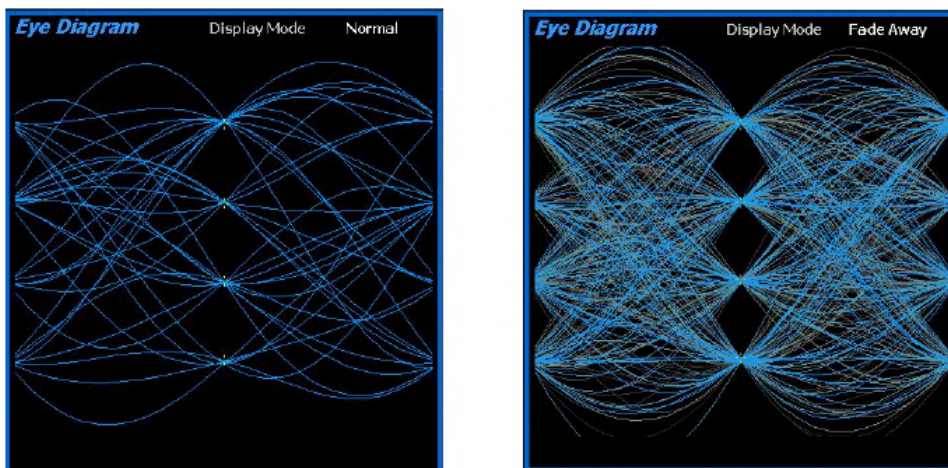

The display includes a Fade Away setting that is similar to the Persistence Mode on an oscilloscope, shown on the right above. The intensity of each trace fades away or decays as new traces are received. The effect is to intensify the display in the area where the waveform spends most of its time.

NOTE

Whenever the Display Mode is changed, the R8200 reconfigures the presentation. This process takes approximately 10 seconds and is complete when the new setting appears in the Display Mode field.

Power Profile

The Power Profile display provides a power versus time plot of the transmitted timeslots. This specialized Oscilloscope display is useful for ensuring that near-far situations will not result in co-channel inter-slot interference on the alternate or non-transmission slot and that the power level will be adequate for acceptable BER performance. For more information, see [ETSI TS 102 361-1 Electromagnetic compatibility and Radio Spectrum Matters \(ERM\); Digital Mobile Radio \(DMR\) Systems; Part 1: "DMR Air Interface \(AI\) protocol," section 10.2.3 Burst timing on page 114.](#)

The scaling and position of the vertical power axis can be adjusted to inspect greater range or detail. The horizontal axis can be changed to view one or both slots including the additional ramp up/down time. Advanced display functions are available: two markers for advanced analysis, shown on the left below as well as overlays of slot centers and burst time regions, shown on the right.

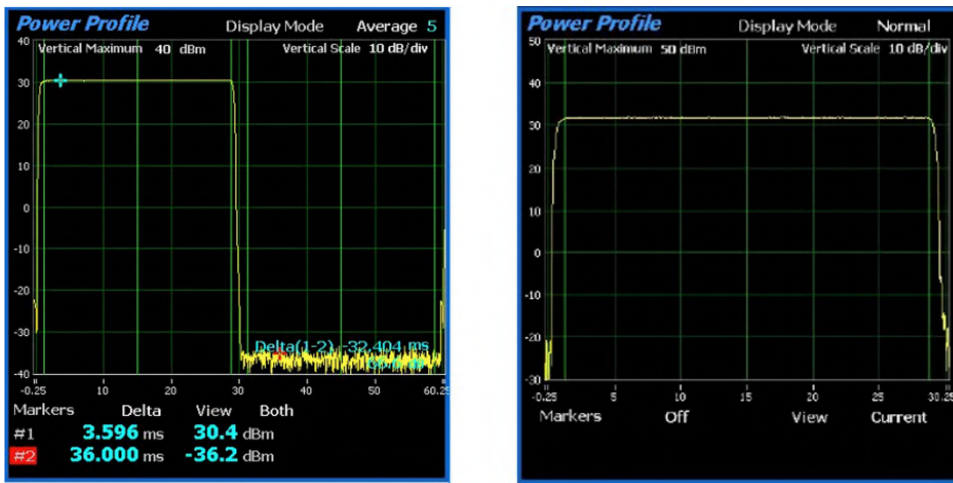

Advanced sweep display modes are also available in the Power Profile display to enhance the usefulness of the measurement trace. Freeze mode provides a snapshot of the current display and terminates the display sweep. Max Hold mode retains the highest peak signal amplitudes measured during continuous successive sweeps. In Average mode, the displayed trace is a rolling average of peak amplitude measured on up to five successive sweeps.

Distribution Plot

This selection displays a graph showing the distribution of symbol deviations of the received signal grouped into frequency bins of 10 Hz or less (i.e., the frequency offset versus the rate of occurrence of that frequency). Each plot consists of at least a second of the most current data available. The protocol consists of four symbol values at

proportional carrier deviations. The four ideal symbol deviations are labeled at gridlines. Additional gridlines half way between labels divide the plot into four equal regions and mark the thresholds where symbol decisions change from one to the other, as shown below.

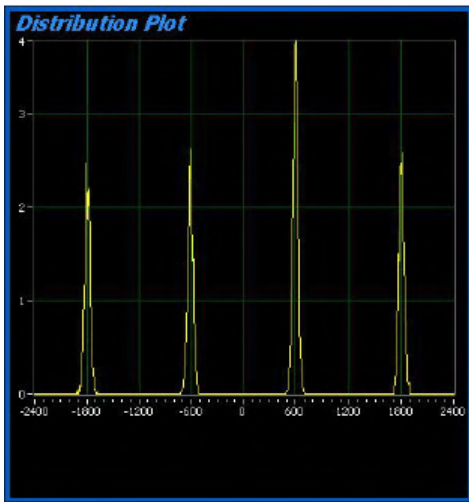

For example, in low power conditions, noise may cause a symbol's deviation to appear in the adjacent region, thus causing a bit error. All distribution amounts are displayed by automatic adjustment of the vertical axis scaling to show the full amount of symbols falling into each bin. Distribution amounts are the percentage of the number of symbols whose deviation falls within that point's frequency bin based on the number of symbols in the analysis population. The better a signal is, the more symbols will actually land in the ideal bin to increase its percentage. Deviations that are past the graph edge limits (e.g., for noise if no signal exists) are collected and shown in the bin at the limit.

NOTE

Sample timing is dependent on the modulation time imposed by a particular digital protocol. For example, sampling is at symbol times for HDQPSK but halfway between symbol times for HCPM. Intersymbol interference inherent in the modulations causes some overshoot exhibited by groups being further from center and having multiple peaks.

Analysis and Protocol Details

The DMR Test Mode includes specialized displays of analysis and protocol details, as shown on the left and right respectively below.

Analysis Details

Symbol Deviation	Measured Deviation	Magnitude Error
-3 -1944 Hz	0.00000	0.00 %
-1 -648 Hz	0.00000	0.00 %
+1 +648 Hz	0.00000	0.00 %
+3 +1944 Hz	0.00000	0.00 %

Protocol Details

Slot Analysed	---
Priority	---
Sync Slot	---
Emergency	<input checked="" type="checkbox"/>
Service Options	0 0
Call/Target Address	0
Network ID:	
Model	---
Net	---
Site	---

Analysis Details offers the measured deviation and error magnitude for each of the four symbol deviation frequencies. Protocol Details offers select configuration values decoded from the monitored signal during performance verification testing. If the test equipment is receiving a transmission from a DMR Tier III base station then the Network ID information will be decoded in the Protocol Details display.

While the analyzer is operating in DMR Test Mode, the DISPLAY Zone soft key menus contain the parameter settings for RF measurement and baseband configuration and measurement.

For DISPLAY Zone soft keys unique to DMR Test Mode, see ["DISPLAY Zone Soft Keys for DMR Transmitter Test" on page 601](#). For a complete soft key reference for the DISPLAY Zone, see ["DISPLAY Zone Soft Keys for Duplex Mode" on page 496](#).

The METER Zone

In DMR Test Mode, the METER Zone is preloaded with a Constellation Meter. A Power Meter and a Voltmeter are also available by pressing **Hot Key 5** > **Select Meter** and choosing the desired selection, as shown.

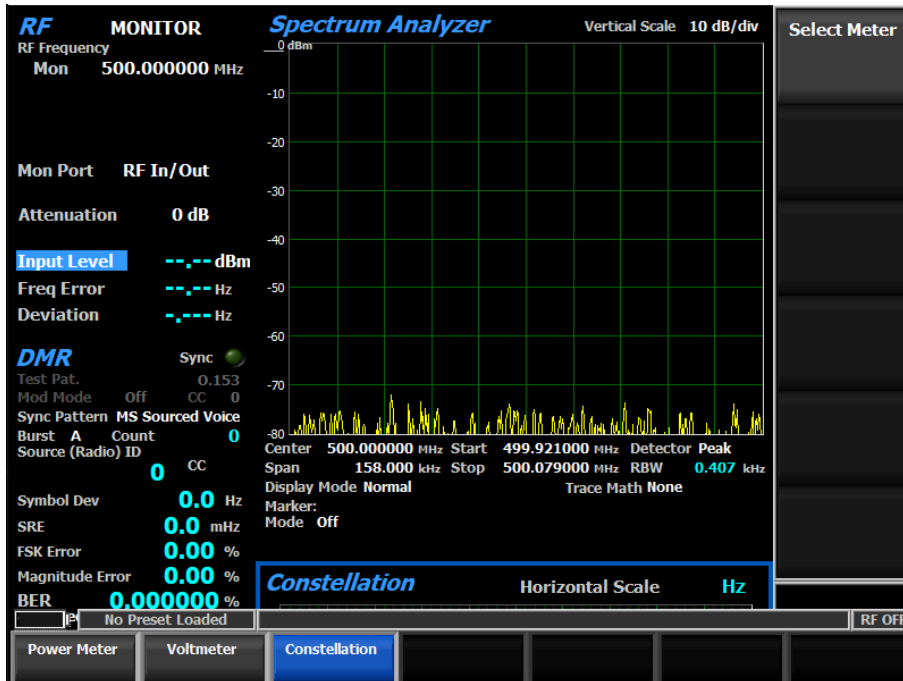

Constellation Meter

The Constellation Meter provides a visual representation of overall transmitter performance, as shown below.

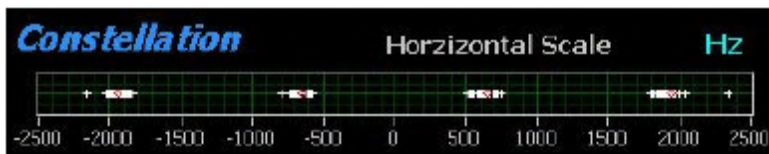

Several digital radio protocols broadcast voice and data using four frequency shift deviations of the carrier to represent symbols containing two data bits. Four red tick marks on the display represent the ideal target frequencies for the deviation states when the radio is transmitting data bit symbols. White tick marks show the measured frequency deviation at symbol decision times. A tighter grouping of white tick marks around the red targets indicates increased transmitter performance.

Power Meter

See ["Power Meter" on page 100](#).

Voltmeter

See **"Voltmeter" on page 101**.

While the analyzer is operating in DMR Test Mode, the METER Zone soft key menus contain all of the parameter settings for RF and baseband measurement metering. For METER Zone soft keys unique to DMR Test Mode, see **"METER Zone Soft Keys for DMR Transmitter Test" on page 607**. For a complete soft key reference for the METER Zone, see **"METER Zone Soft Keys for Monitor Mode" on page 401**.

To learn about using the R8200 to service portables, mobiles, and system infrastructure employing the DMR protocol, turn to **"Using DMR Test Mode" on the next page**.

Using DMR Test Mode

This section provides an example measurement using the analyzer's DMR Mode. Complete this procedure to make an initial verification of a portable radio's digital signal processing without the need for specialized power supplies, test boxes, or radio service software. It can be completed using only the radio, a single BNC cable, and two adapters. For more detailed examples of how to test DMR devices, see [Freedom Application Note FCT-1014 "Testing DMR devices in operational mode using the Freedom Communications System Analyzer"](#).

Transceiver Verification

This section describes a simple procedure for verifying the basic functionality of the radio's RF transceiver and physical layer protocol using the R8200 in DMR Mode. Follow these steps to connect the radio to the R8200 and configure your measurement.

Required Equipment

- Freedom R8200 Communications System Analyzer
- Portable Radio, programmed for DMR (i.e., Motorola XPR7550E or Kenwood NX5000 or similar)
- Cable, coax, BNC (m-m)
- Adapter, Type N(f)-to-BNC(f)
- Adapter, SMA(f)-to-BNC(f)

Test Setup

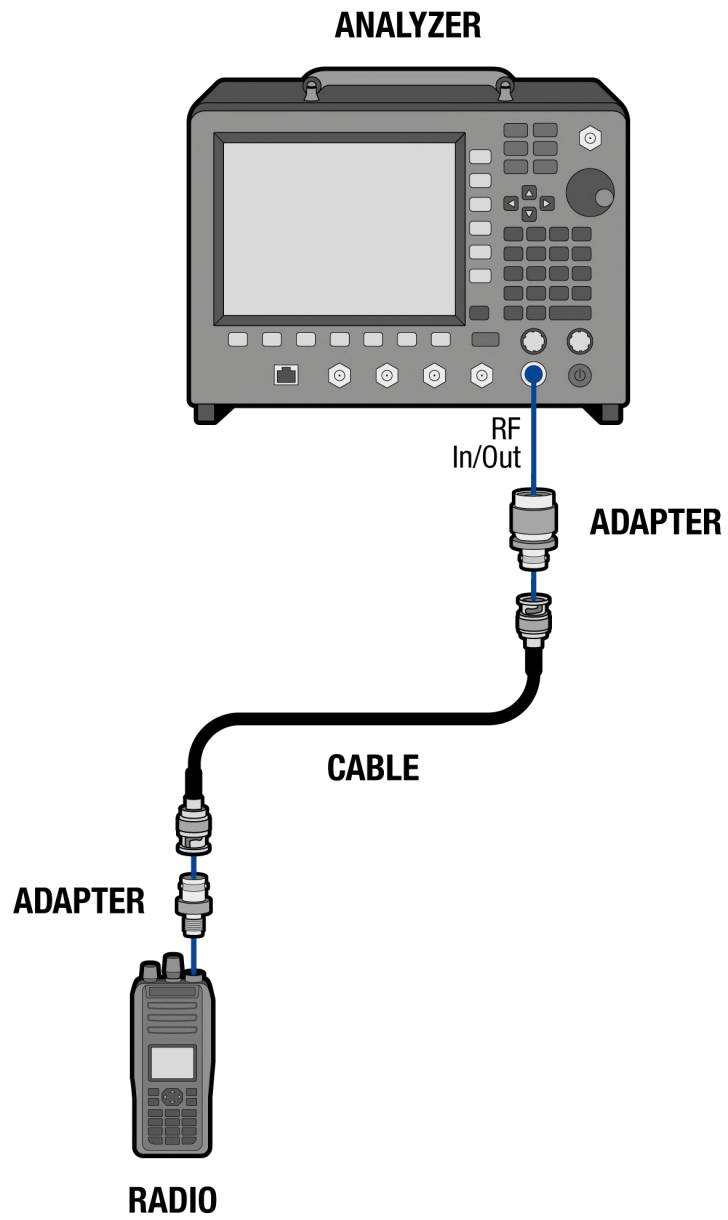

Procedure

Steps	Actions	Notes
1. Configure the test setup.	<ul style="list-style-type: none"> a. Connect the Type N(f)-to-BNC(f) adapter to the R8200's RF In/Out port. b. Remove the antenna from the radio. c. Connect the SMA(f)-to-BNC(f) Adapter to the Antenna port of the radio. d. Connect the BNC cable between the radio and the R8200. 	
2. Configure the R8200.	<ul style="list-style-type: none"> a. To access the DMR test mode press Test > Test Mode > DMR. b. Press Monitor. c. To set the receiver Center Frequency to match the radio transmitter, press Hot Key 1 > Monitor Frequency > 851 > MHz. d. In the RF Zone, confirm that Mon Port displays RF In/Out as the receiver's input. 	<p>Alternatively, press RF Zone > Monitor Frequency > 851 > MHz.</p> <p>If not, press Mon Port > RF In/Out > Enter.</p>
3. Activate and key the radio.	<ul style="list-style-type: none"> a. Turn the On/Off/Volume Knob clockwise to activate the radio. b. Press PTT on the portable. 	This initiates a broadcast of the voice content picked up by the radio microphone.
4. Observe the DISPLAY Zone.	<ul style="list-style-type: none"> a. Confirm that the Spectrum Analyzer displays the radio's transmitted carrier signal. 	You should observe a jump in signal on Spectrum Analyzer. Allow time for auto attenuation to activate and sta-

Steps	Actions	Notes
5. Observe the RF Zone.	<ul style="list-style-type: none"> a. Confirm that the Input Level displays the radio's output as approximately 3 W. b. Confirm that the Freq Error displays the radio's frequency error as less than 100 Hz. 	<p>bilize the Spectrum Analyzer level.</p> <p>This verifies the performance of the radio's RF transmitter.</p>
6. Observe the DMR Zone.	<ul style="list-style-type: none"> a. Note the SYNC LED is illuminated. Confirm that CC displays a valid Color Code. b. Confirm that FSK error displays less than 5%. c. Confirm that Magnitude Error displays less than 1%. 	<p>This verifies that the radio correctly encoding the DMR message content.</p> <p>Having confirmed these transmission parameters, you can verify that the transmitter on this radio is working properly in DMR Test Mode.</p>
7. Configure the R8200.	<ul style="list-style-type: none"> a. To set the transmitter Generate Frequency to match the radio receiver, press Duplex > Hot Key 1 > Generate Frequency > 851 > MHz. b. To Copy the CC to the Generator, press Hot Key 4 > More > Copy CC to Generator. c. To generate a standard DMR test pattern, press Hot Key 4 > Test Pattern > 1031 Hz Tone. d. To modulate the RF carrier, press Modulation Mode > Continuous. 	<p>Alternatively, press Hot Key 1 > Copy Frequency to Generator.</p>
8. Listen for the 1031 Hz tone broadcast from the radio's speaker.	<ul style="list-style-type: none"> a. Adjust the volume of the 1031 Hz tone using the radio's 	<p>This verifies that the radio correctly decodes the DMR baseband content.</p>

Steps	Actions	Notes
9. Test the sensitivity of the radio.	<p data-bbox="654 264 870 296">On/Off/Volume Knob.</p> <p data-bbox="613 310 992 426">a. To adjust the Output Level of the R8200, press Hot Key 1 > Output Level.</p> <p data-bbox="613 449 992 646">b. Use the arrow keys and the tuning knob to decrease the Output Level until the 1031 Hz tone is no longer broadcast from the radio speaker.</p> <p data-bbox="613 669 992 783">c. Confirm that the RF Output Level on the R8200 <i>is less than -120 dBm</i> when the tone disappears.</p>	<p data-bbox="1013 659 1398 772">This confirms that the radio receiver is sensitive to transmissions as weak as -120 dBm.</p>

Having confirmed these parameters, you can verify that the transceiver on this radio is working properly in DMR Test Mode.

Introducing PROJECT 25 Test Mode

The optional R8200 PROJECT 25 (P25) Test Mode allows testing of conventional (non-trunked) APCO Project 25 phase 1 (P25) compliant mobile stations (radios) and base stations (repeaters) in simplex and duplex modes. P25 radios use a digital transmission format employing Continuous 4 level FM (C4FM) modulation. P25 repeaters may also transmit LSM (Linear Simulcast Modulation) and WCQPSK (wide Continuous Quadrature Phase Shift Keying) modulation schemes, which are compatible with C4FM receivers. The R8200 PROJECT 25 Test Mode provides test functions compliant with the TIA/EIA-102.CAAA measurement standard. These include Modulation Fidelity, Symbol Deviation, Symbol Rate Error, Bit Error Rate (BER) test patterns, Frequency Error, and Power. A means is provided to change the Network Access Code (NAC) and edit the P25 Voice Frame to adapt to the system under test. In addition, the PROJECT 25 Test Mode is equipped with a Spectrum Analyzer, Oscilloscope, Bar Graphs, Eye Diagram, Voice Frame Decode, Constellation Plot and Distribution Plot as well as a Voice Loopback function that enables the Voice Loop feature (U.S. patent 5703479) for audio verification of the radio's end-to-end operation.



Pressing **Test > Test Mode > PROJECT 25** configures the R8200 for PROJECT 25 protocol testing, as shown above. On the R8200 main display, the Standard Mode AUDIO Zone and associated soft keys are replaced by the PROJECT 25 Zone and PROJECT 25-specific soft keys (accessed by pressing the **PROJECT 25** soft key).

NOTE

The manufacturer's Radio Service Software (RSS) is required to perform some tests in P25 Mode because certain measurements (BER) require placing the radio in a special test mode. Tests that do not require RSS include Power, Frequency Error, Modulation Fidelity, Symbol Deviation, and Symbol Rate Error. Averaging can be applied to some measurements via the System Settings. The Eye Diagram, Constellation Plot, Distribution Plot, and Voice Loopback also provide qualitative indication of the radio's performance.

The RF Zone

In PROJECT 25 Test Mode, the RF Zone displays parameters associated with the PROJECT 25 carrier stimulus generated by the R8200 as well as measurements of the RF transmissions received from the radio under test. The RF Zone during PROJECT 25 transmitter testing with the R8200 in Monitor (below left) and Duplex Mode (below right), while the RF Zone during PROJECT 25 receiver testing (with the R8200 in Generate Mode) is shown in the center below.

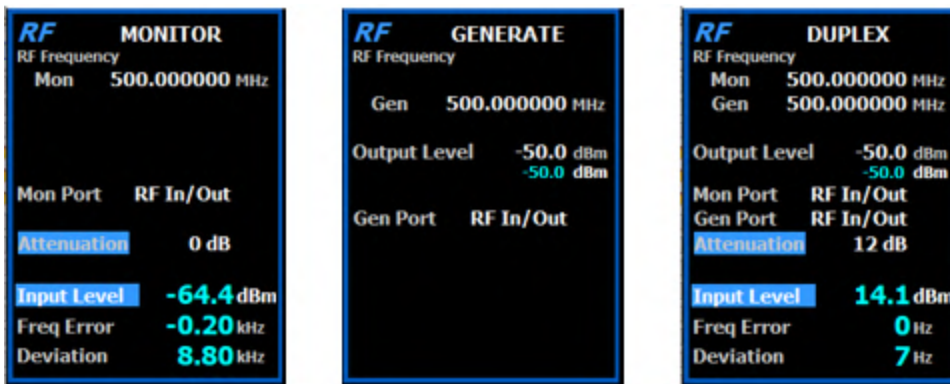

During PROJECT 25 Test Mode, the RF Zone offers the following measurement displays:

Input Level – Displays the average power in the specified Burst of the synchronized TDMA slot of the received signal.

NOTE

Although Input Level is used for Squelch, Squelch has no effect on measurement updates.

When the RF input power on the RF In/Out port is above +20 dBm (100 mW), the R8200 utilizes a broadband power detector for the measurement. The Input Level field in the RF Zone changes to Watt Meter to indicate this measurement mode. For best accuracy disable the Pre-amplifier in Monitor Mode, and set the Gen Port in Generate Mode to RF In/Out.

Watt Meter – Displays the level of broadband power applied to the RF In/Out port when the RF input power on the RF In/Out port is above +20 dBm (100 mW).

Freq Error – Displays the difference between the received PROJECT 25 carrier frequency and the R8200 Monitor Frequency.

Deviation – Displays the negative and positive peak frequency deviation of a modulated carrier (i.e., from the Frequency Error mean), available when Modulation Mode is FM.

While the analyzer is operating in PROJECT 25 Test Mode, the RF Zone soft key menus contain all of the parameter settings for the controlling the R8200 RF output. For a complete soft key reference for the RF Zone, see "**RF Zone Soft Keys for Duplex Mode**" on page 462.

The PROJECT 25 Zone

While operating in PROJECT 25 Test Mode, the AUDIO Zone and associated soft keys are replaced by the PROJECT 25 Zone and PROJECT 25-specific soft keys. The PROJECT 25 Zone displays the physical layer parameters that can be configured to encode and decode PROJECT 25 content. The PROJECT 25 Zone is shown in Monitor Mode on the left, Generate Mode in the middle, and Duplex Mode on the right, below.



The PROJECT 25 Zone offers the following measurement displays:

NAC – The Network Access Code is displayed as hexadecimal 000 to FFF and decoded from the P25 embedded signaling data in the voice frames of the radio or system under test. NAC is digital ID information equivalent to CTCSS/PL and CDCSS/DPL in analog FM radio systems. The R8200 can receive transmissions from a radio under test pro-

grammed with any NAC, but the radio requires the R8200 to transmit the specific NAC programmed into the radio. See **"Copy NAC to Generator (Project 25 submenu)" on page 620** to configure the R8200 to transmit back to that radio.

Mod Fidelity – Modulation Fidelity (FSK error) represents how accurately a P25 transmitter reproduces an ideal theoretical modulation waveform. The measurement is performed by first removing frequency error and symbol deviation gain error from the received signal, then computing the RMS difference between the deviation of the resulting signal at each symbol decision point and the ideal deviations of those symbols; no bit errors should be detected. On the R8200 this is computed over a 72 symbol interval and reported as an RMS error in % relative to the mean deviation across symbols.

Symbol Dev – Provides the deviation measurement at symbol decision times. P25 radios broadcast voice and data using a four level frequency deviation of the carrier to represent symbols containing data bits as shown in the table below. The nominal deviation value for a Project 25 radio using C4FM modulation is 1800 Hz. Since the deviation of a Project 25 C4FM signal is data dependent, that aspect is factored when measuring overall carrier deviation.

Bits	Symbol	Carrier Frequency Deviation
01	+3	+1800 Hz
00	+1	+600 Hz
10	-1	-600 Hz
11	-3	-1800 Hz

Sym Rate Err – Provides a measurement of the transmitter symbol rate accuracy, the difference of the actual minus the ideal. Thus, a positive error indicates that the transmitter clock is too fast. P25 standard TIA-102.CAAB-B 3.2.17 Symbol Rate Accuracy states that the symbol rate error shall not exceed 10 PPM, which is ± 48 mHz given the ideal symbol rate of 4800 baud. The measurement is designed to provide much better accuracy by continually refining the measurement over time. A Reset Symbol Rate Error soft key is provided to restart the measurement.

BER – Displays the percentage of bit differences between the bits of the Test Pattern and the bits from the received synchronized TDMA signal. This bit error rate test checks the modulation, encoding, and timing of the transmit signal during the data transmission period. When performing the BER Test, the radio transmitter under test must be placed into a test diagnostic mode with the correct TX test pattern selected using the manufacturer's Radio Service Software (RSS). The test is done at nominal power with the radio transmitting the test pattern into the service monitor. It is acceptable to have an attenuator between the radio under test and the service monitor.

While the analyzer is operating in PROJECT 25 Test Mode, the PROJECT 25 Zone soft key menus contain all of the R8200 parameter settings for the controlling the PROJECT 25 physical layer. For a complete soft key reference for the PROJECT 25 Zone, see **"PROJECT 25 Zone Soft Keys" on page 616**.

The DISPLAY Zone

During PROJECT 25 Test Mode, the DISPLAY Zone is preconfigured with the Voice Frame Decode display, but also offers a Spectrum Analyzer, Oscilloscope, Bar Graphs, Eye Diagram, Voice Frame Decode, Constellation Plot, and Distribution Plot, accessed by pressing **Select Display**, as shown in the horizontal soft key menu below.

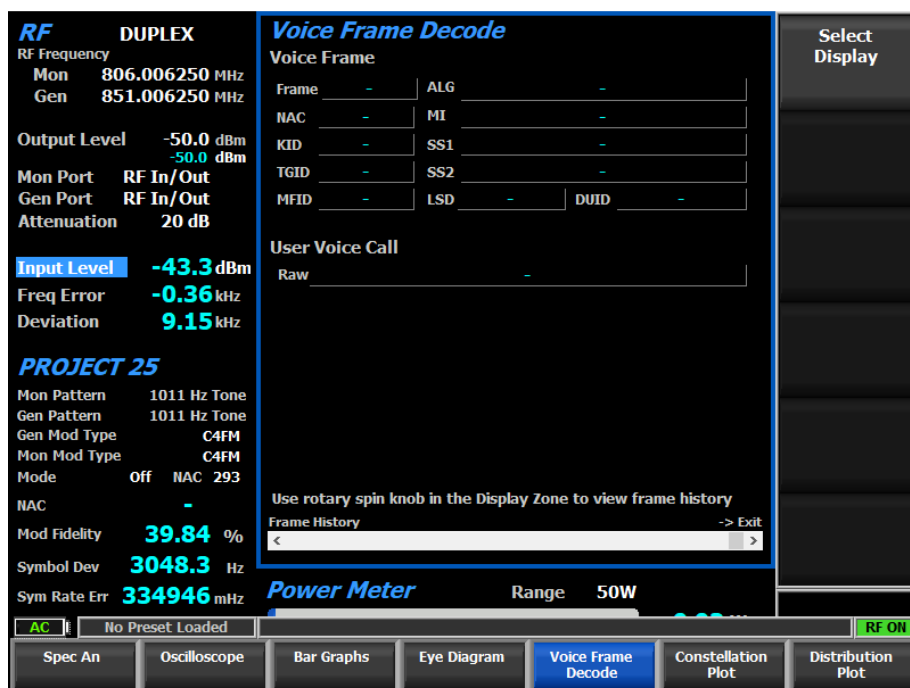

Spectrum Analyzer

See **"Introducing the Spectrum Analyzer" on page 93**.

Oscilloscope

See **"Introducing the Oscilloscope" on page 96**.

Bar Graphs

See "Bar Graphs" on page 80.

Eye Diagram

See "Eye Diagram" on page 157.

Voice Frame Decode

Provides the decoded data from the P25 embedded signaling. Rotate the tuning knob CCW to view the frame history in the DISPLAY Zone (Frame # indicates the position); Clockwise exits history. The Voice Frame fields are from the header word and interspersed status symbols.

NOTE

The Voice Frame header's TGID and MFID are not displayed; see the User Voice Call fields for the Link Control code word's Group Address and MFID, if applicable.



Although encryption is not supported, Header Word fields and the Link Control Format (LCF) will be displayed correctly because they are not subject to encryption. Therefore, if these fields indicate encryption, other fields will not be displayed correctly. Fields that are subject to encryption include the vocoder information and Link Control information content. See the table below.

Field	Mnemonic	Bits	Notes
Network Identifier	NID	16	
Network Access Code	NAC	12	
Data Unit ID	DUID	4	
Header Word		120	
Message Indicator	MI	72	Encryption is not supported
Manufacturer's ID	MFID	8	Not displayed
Algorithm ID	ALG	8	Encryption is not supported; 80 is unencrypted
Key ID	KID	16	Encryption is not supported
Talk-group ID	TGID	16	Not displayed
Link Control	LC	72	Format varies
Format	LCF	8	
Protected flag	P	1	Encryption is not supported
Standard Format	SF	1	
Opcode	LCO	6	
Content		56	
Low Speed Data	LSD	32	
Status Symbols (6)	SS	12	

Status symbols are combined by concatenating their binary values but are displayed in hexadecimal. For example, an idle channel that just became busy is displayed as D5 (11010101). See the table below.

Value (binary)	Notes	Transmitter
00	Unknown, use for talk-around	subscriber
01	Inbound Channel is Busy	base station/repeater
10	Unknown, use for inbound or outbound	subscriber
10	Inbound Channel is Idle	base station/repeater

The DUID field is LDU1 if the frame contained just the first Logical Link Control Unit before the terminator. It is LDU1:LDU2 if the frame contains both the first and second before the terminator; they are combined to display the complete information together. See the table below.

Value	DUID	Note
0	HEADER	Header Data Unit
3	TERM	Terminator without LC
5	LDU1	Logical Link Data Unit 1
7	TSBK	Trunking Signaling Data Unit (block)
10 (and 5)	LDU1:LDU2	Logical Link Data Unit 2 (and 1)
12	PDU	Packet Data Unit
14	TERM(LC)	Terminator with LC
-	-	Reserved

The User Voice Call fields are from the Link Control code word.

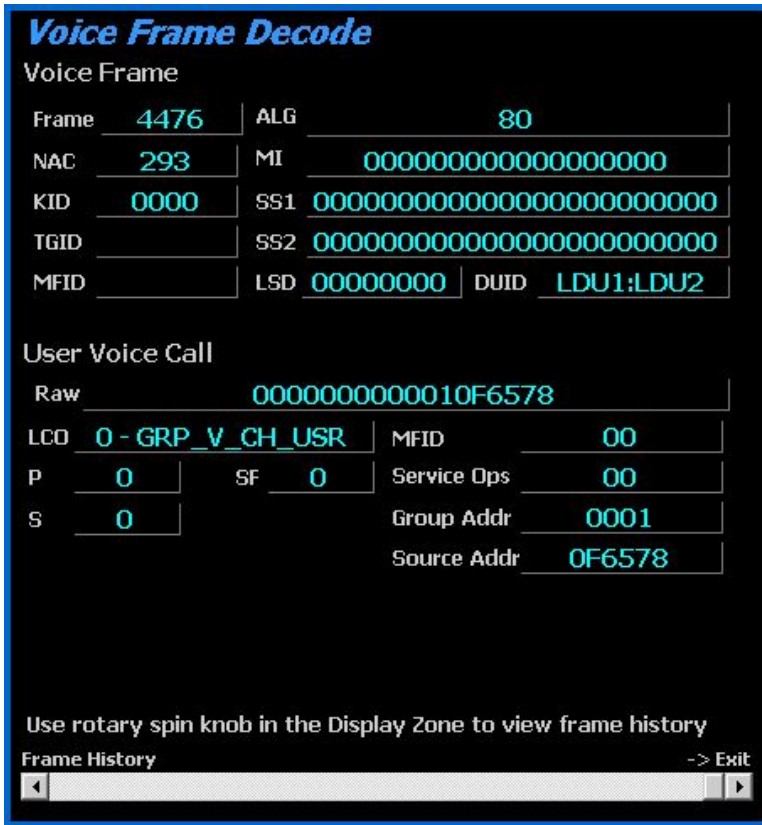

Raw displays all nine bytes directly; subsequent fields display the same information in individual fields according to the Link Control opcode (LCO), if applicable. The **0 - GRP_V_CH_USR** (Group Voice Channel User) message indicates the user of this channel for group voice traffic on both inbound and outbound messages.

The **3 - LC_U2U_V_CH_USR** (Unit to Unit Voice Channel User) message indicates the user of this channel for unit to unit voice traffic, on both inbound and outbound messages and on conventional and trunked systems.

Service options are combined by adding their respective values. For example, Emergency, Duplex, and Highest Priority Level options combined have a value of A1. See the following table.

Name	Mnemonic	Bits	Value	Note
Emergency	E	1	80	
Protected	P	1	40	Encryption is not supported

Name	Mnemonic	Bits	Value	Note
Duplex	D	1	20	
Mode	M	1	10	
Reserved	R	1	08	0 is specified
Priority Level		3	01 to 07	Highest to lowest

Constellation Plot

Displays the EVM measurement and a graph showing the symbol constellation on the complex I/Q plane. The display provides a visual representation of general transmitter performance when the Monitor Modulation Type is complex. P25 LSM/WCQPSK radios broadcast voice and data using eight differential phase shift deviations from the carrier to represent symbols containing three data bits. One of eight phase shifts relative to the carrier's current phase yields eight phase points. The phase trajectory never passes through the origin, ensuring that signal amplitude never falls to zero during data transmissions. An ideal constellation is shown below.

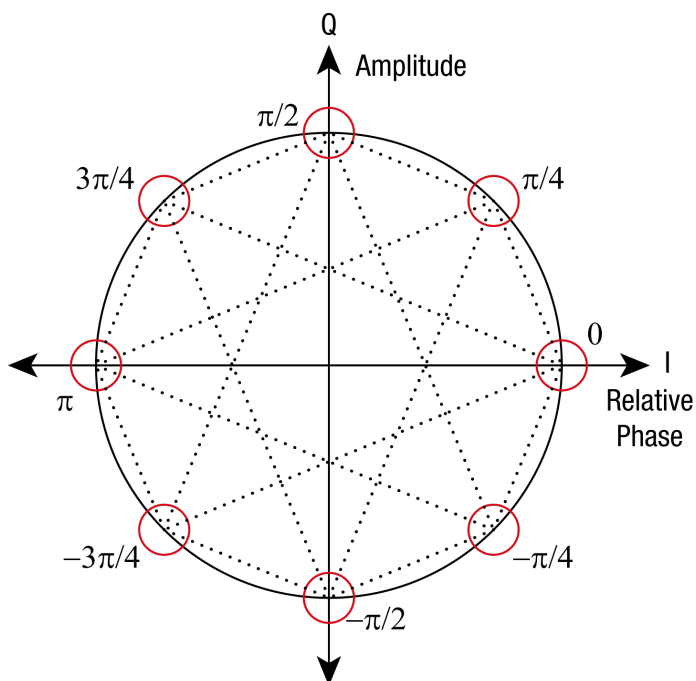

The center of the eight red circles on the display represent the expected locations for the deviation states when the radio is transmitting data bit symbols using the modulation. White dots show the actual deviation measurement at symbol decision times. A tighter grouping within the red circles indicates more accurate transmitter performance. The radius of the circles is the 10% EVM (Peak) limit.

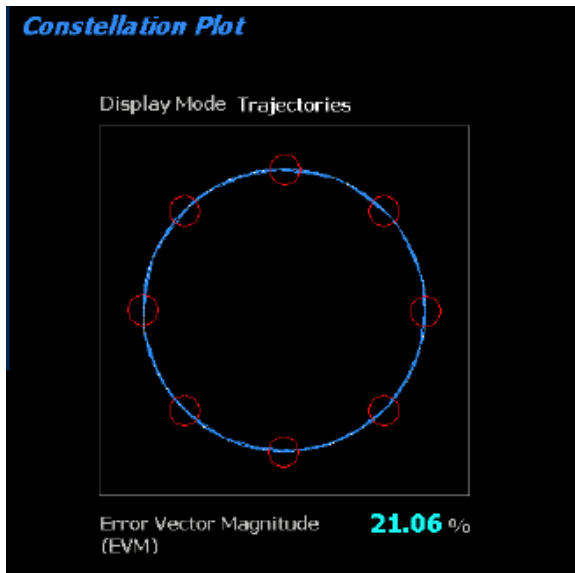

The measurement is executed at the optimal symbol times and positions to exclude the adverse effects of frequency error and residual carrier. Its Display Mode setting enables the plotting of symbols, samples (left, below), or trajectories (right, below). The Error Vector Magnitude (RMS) display provides a quantitative representation of overall transmitter performance.

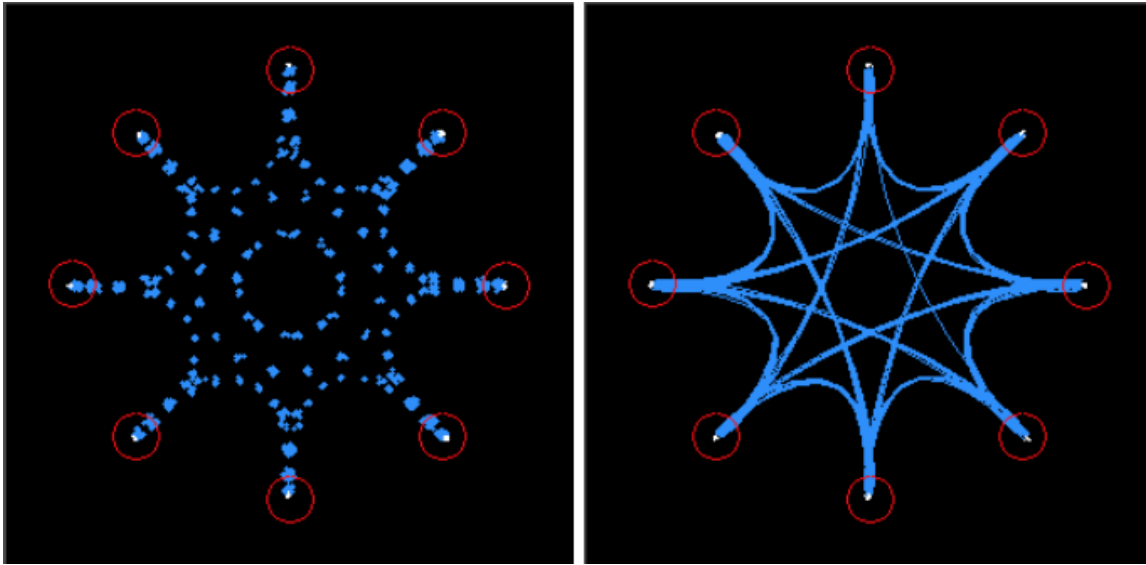

Distribution Plot

Displays a graph showing the distribution of symbol deviations of the received signal grouped into frequency bins of 10 Hz or less (i.e., the frequency offset versus the rate of occurrence of that frequency). Each plot consists of at least a second of the most current data available. The protocol consists of four symbol values (-3, -1, +1, +3) at proportional carrier deviations, as shown below.

Bits	Symbol	Carrier Frequency Deviation
01	+3	+1800 Hz
00	+1	+600 Hz
10	-1	-600 Hz
11	-3	-1800 Hz

The four ideal symbol deviations are labeled at gridlines. Additional gridlines half way between labels divide the plot into four equal regions and mark the thresholds where symbol decisions change from one to the other. A Distribution Plot of a 1011 Hz tone is shown below.



For example, in low power conditions, noise may cause a symbol's deviation to appear in the adjacent region, thus causing a bit error. All distribution amounts are displayed by automatic adjustment of the vertical axis scaling to show the full amount of symbols falling into each bin. Distribution amounts are the percentage of the number of symbols whose deviation falls within that point's frequency bin based on the number of symbols in the analysis population. The better a signal is, the more symbols will actually land in the ideal bin to increase its percentage. Deviations that are past the graph edge limits (e.g., for noise if no signal exists) are collected and shown in the bin at the limit.

While the analyzer is operating in PROJECT 25 Test Mode, the DISPLAY Zone soft key menus contain all of the parameter settings for RF and baseband measurement display. For DISPLAY Zone soft keys unique to PROJECT 25 Test Mode, see ["DISPLAY Zone Soft Keys for PROJECT 25 Transmitter Test" on page 620](#). For a complete soft key reference for the DISPLAY Zone, see ["DISPLAY Zone Soft Keys for Duplex Mode" on page 496](#).

The METER Zone

In PROJECT 25 Test Mode, the METER Zone is preloaded with a Power Meter, as shown.



A Voltmeter, Decoder and RF Scan Meter are also available by pressing **Hot Key 5** > **Select Meter** and choosing the desired selection.

Power Meter

See ["Power Meter" on page 100](#).

Voltmeter

See ["Voltmeter" on page 101](#).

Decoder

See ["Decoder" on page 102](#).

RF Scan

["RF Scan" on page 106](#).

While the analyzer is operating in PROJECT 25 Test Mode, the METER Zone soft key menus contain all of the parameter settings for RF and baseband measurement metering. For METER Zone soft keys unique to PROJECT 25 Test Mode, see **"DISPLAY Zone Soft Keys for PROJECT 25 Transmitter Test" on page 620**. For a complete soft key reference for the METER Zone, see **"METER Zone Soft Keys for Monitor Mode" on page 401**.

To learn about using the R8200 to service portables, mobiles, and system infrastructure employing the PROJECT 25 protocol, turn to **"Using PROJECT 25 Test Mode" on the next page**

Using PROJECT 25 Test Mode

This section provides an example measurement using the analyzer's PROJECT 25 Test Mode. Complete this procedure to make an initial verification of a portable radio's digital signal processing without the need for specialized power supplies, test boxes, or radio service software. It can be completed using only the radio, a single BNC cable, and two adapters.

Transceiver Verification

This section describes a simple procedure for verifying the basic functionality of the radio's RF transceiver using the R8200 in PROJECT 25 Test Mode. Follow these steps to connect the radio to the R8200 and configure your measurement.

Required Equipment

- Freedom R8200 Communications System Analyzer
- Portable Radio, programmed for Project 25 (i.e., Motorola APX 6000 or similar)
- Cable, coax, BNC (m-m)
- Adapter, Type N(f)-to-BNC(f)
- Adapter, SMA(f)-to-BNC(f)

Test Setup

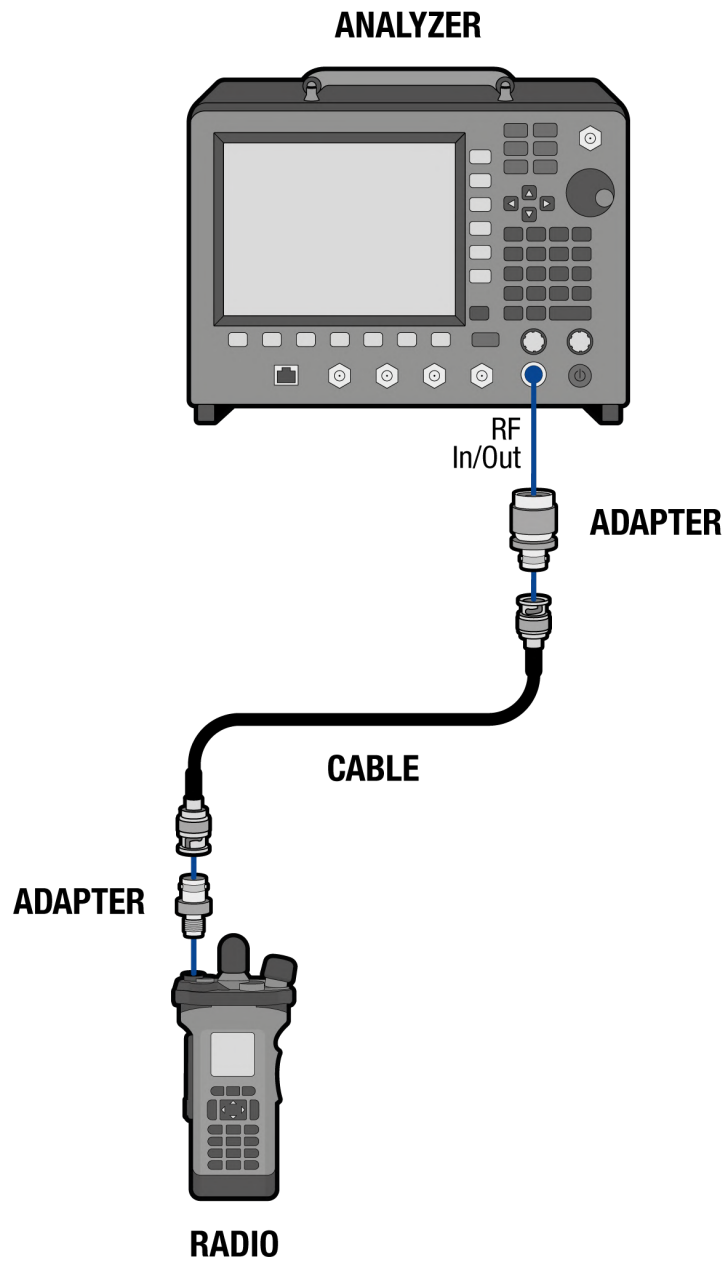

Procedure

Steps	Actions	Notes
1. Configure the test setup.	<p>a. Connect the Type N(f)-to-BNC(f) adapter to the R8200's RF In/Out port.</p> <p>b. Remove the antenna from the radio.</p> <p>c. Connect the SMA(f)-to-BNC(f) Adapter to the Antenna port of the radio.</p> <p>d. Connect the BNC cable between the radio and the R8200.</p>	
2. Configure the R8200.	<p>a. Press Monitor.</p> <p>b. To set the receiver Center Frequency to match the radio transmitter, press Hot Key 1 > Monitor Frequency > 851 > MHz.</p> <p>c. In the RF Zone, confirm that Mon Port displays RF In/Out as the receiver's input.</p> <p>d. Auto Attenuation is selected per system default. No need to adjust attenuation with Auto Attenuation.</p> <p>e. To access the PROJECT 25 Test Mode, press Test > Test Mode > PROJECT 25.</p>	<p>Alternatively, press RF Zone > Monitor Frequency > 851 > MHz.</p> <p>If not, press Mon Port > RF In/Out > Enter.</p> <p>This opens the PROJECT 25 Test menu.</p>
3. Activate and key the radio.	<p>a. Turn the On/Off/Volume Knob clockwise to activate the radio.</p>	<p>This initiates a broadcast of the voice content picked up by the radio micro-</p>

Steps	Actions	Notes
	b. Press PTT on the portable.	phone.
4. Observe the DISPLAY Zone.	a. Confirm that the analyzer is decoding the radio's transmitted Voice Frame Data.	You should observe change in the Voice Frame Data display.
5. Observe the RF Zone.	<p>a. Confirm that the Input Level displays the radio's output as approximately 3 W.</p> <p>b. Confirm that the Freq Error displays the radio's frequency error as <i>less than 100 Hz</i>.</p>	This verifies the performance of the radio's RF transmitter.
6. Observe the PROJECT 25 Zone.	<p>a. Confirm that NAC displays a valid Network Access Code.</p> <p>b. Confirm that Mod Fidelity displays <i>less than 1%</i>.</p> <p>c. Confirm that Symbol Dev displays <i>less than 2 kHz</i>.</p>	<p>This verifies that the radio correctly encoding the PROJECT 25 message content.</p> <p>Having confirmed these transmission parameters, you can verify that the transmitter on this radio is working properly in PROJECT 25 Test Mode.</p>
7. Configure the R8200.	<p>a. To set the transmitter Generate Frequency to match the radio receiver, press Hot Key 1 > Generate Frequency > 851 > MHz.</p> <p>b. To Copy the NAC to the Generator, press Hot Key 4 > More > Copy NAC to Generator.</p> <p>c. To begin transmitting RF from the R8200, press Hot Key 1 > Gen Port RF In/Out.</p> <p>d. To generate a standard P25 test pattern, press Hot Key 4 > Gen Test Pattern > 1011 Hz Tone.</p>	

Steps	Actions	Notes
	<ul style="list-style-type: none"> e. To modulate the RF carrier, press Modulation Mode > Continuous. 	
8. Listen for the 1 kHz tone broadcast from the radio's speaker.	<ul style="list-style-type: none"> a. Adjust the volume of the 1011 Hz tone using the radio's On/Off/Volume Knob. 	This verifies that the radio correctly decodes the PROJECT 25 baseband content.
9. Test the sensitivity of the radio.	<ul style="list-style-type: none"> a. To adjust the Output Level of the R8200, press Hot Key 1 > Output Level. b. Use the arrow keys and the tuning knob to decrease the Output Level until the 1011 Hz tone is no longer broadcast from the radio speaker. c. Confirm that the RF Output Level on the R8200 is <i>less than -120 dBm</i> when the tone disappears. 	This confirms that the radio receiver is sensitive to transmissions as weak as -120 dBm.

Having confirmed these parameters, you can verify that the transceiver on this radio is working properly in PROJECT 25 Test Mode.

Introducing P25 Trunk Mode

The optional R8200 P25 Trunk Test Mode allows testing of trunked APCO Project 25 (P25) compliant radios. P25 mobile stations (radios) use a digital transmission format employing Continuous 4 level FM (C4FM) modulation. The R8200 P25 Trunk Mode simulates the functions of a Project 25 central controller with the control and voice channel protocols needed for various tests. The simulation can be configured to generate C4FM as well as LSM (Linear Simulcast Modulation) and WCQPSK (wide Continuous Quadrature Phase Shift Keying). The R8200 P25 Trunk Test Mode provides test functions compliant with the trunked APCO Project 25 measurement standard. These include Modulation Fidelity, Symbol Deviation, Symbol Rate Error, TIA/EIA-102.CAAA compliant Bit Error Rate (BER) test patterns, Frequency Error, and Power. Also included are Frequency Error and Power meters, a Spectrum Analyzer, Oscilloscope, Eye Diagram, and Distribution Plot with graphical representation of the P25 signal, and modulation signal quality meters.

A Voice Loop feature (U.S. patent 5703479) is engaged for audio verification of the radio's end-to-end operation after the subscriber unit transmits. During a Voice Call, the R8200 automatically records voice channel data while the subscriber unit PTT is pressed then retransmits it to provide audio verification of the radio's end-to-end operation.

NOTE

The manufacturer's Radio Service Software (RSS) is required to perform some tests in P25 Trunk Mode because certain measurements (BER) require placing the radio in a special test mode.

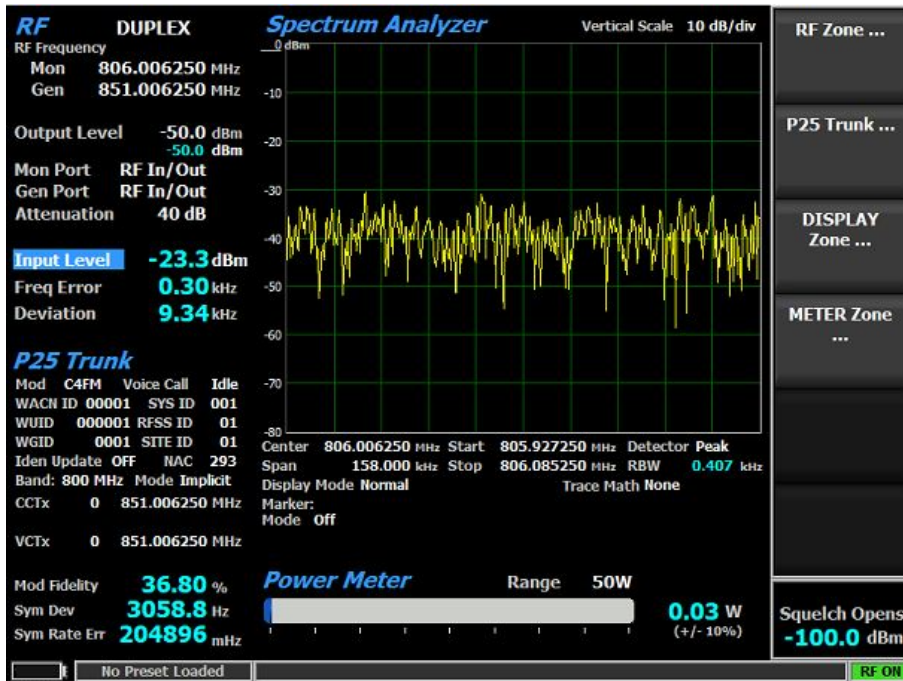

Pressing **Test > Test Mode > P25 Trunk** configures the R8200 for P25 Trunk protocol testing, as shown above. On the R8200 main display, the Standard Mode AUDIO Zone and associated soft keys are replaced by the P25 Trunk Zone and P25 Trunk-specific soft keys (accessed by pressing the **P25 Trunk** soft key).

The RF Zone

When the P25 Trunk Test Mode is selected, the R8200 is automatically placed in Duplex Mode and begins transmitting idle messages on the control channel with no encryption. While the RF Zone is typically used to configure various settings such as input and output frequency, output level, attenuation, and ports, unlike the conventional PROJECT 25 Test Mode, the Monitor Frequency and Generate Frequency soft keys are not available in P25 Trunk Test Mode. These parameters are determined by settings displayed in the P25 Trunk Zone. They can be altered using the associated soft keys or via entries in the Bandplan Table.

NOTE

RF Zone Monitor and Generate frequency settings can be changed for the BER Test. Otherwise, they are read-only and updated in real-time to show the control channel frequencies or the voice channel frequencies that are in use.

The RF Zone during P25 Trunk transceiver testing (with the R8200 in Duplex Mode) is shown, below.

RF		DUPLEX	
RF Frequency			
Mon	806.006250	MHz	
Gen	851.006250	MHz	
Output Level	-50.0	dBm	
	-50.0	dBm	
Mon Port	RF In/Out		
Gen Port	RF In/Out		
Attenuation	40 dB		
Input Level	-60.5	dBm	
Freq Error	-0.16	kHz	
Deviation	9.03	kHz	

During P25 Trunk Test Mode, the RF Zone offers the following measurement displays:

Input Level – Displays the average power in the specified Burst of the synchronized TDMA slot of the received signal.

NOTE

Although Input Level is used for Squelch, Squelch has no effect on measurement updates.

When the RF input power on the RF In/Out port is above +20 dBm (100 mW), the R8200 utilizes a broadband power detector for the measurement. The Input Level field in the RF Zone changes to Watt Meter to indicate this measurement mode. For best accuracy, disable the Pre-amplifier in Monitor Mode and set the Gen Port in Generate Mode to RF In/Out.

Watt Meter – Displays the level of broadband power applied to the RF In/Out port when the RF input power on the RF In/Out port is above +20 dBm (100 mW).

Freq Error – Displays the difference between the received PROJECT 25 Trunk carrier frequency and the R8200 Monitor Frequency.

Deviation – Displays the negative and positive peak frequency deviation of a modulated carrier (i.e., from the Frequency Error mean), available when Modulation Mode is FM.

While the analyzer is operating in P25 Trunk Test Mode, the RF Zone soft key menus contain most of the parameter settings for the controlling the R8200 RF output, except for the Mon and Gen Frequencies which are controlled by parameters within the Bandplan Table. For a complete soft key reference for the RF Zone, see "[RF Zone Soft Keys for Duplex Mode](#)" on page 462.

The P25 Trunk Zone

While operating in P25 Trunk Test Mode, the AUDIO Zone and associated soft keys are replaced by the P25 Trunk Zone and P25 Trunk-specific soft keys. The P25 Trunk Zone displays the physical layer parameters that can be configured to encode and decode P25 Trunk content. Pressing **P25 Trunk** displays a submenu with the following settings. The P25 Trunk Zone is shown below.

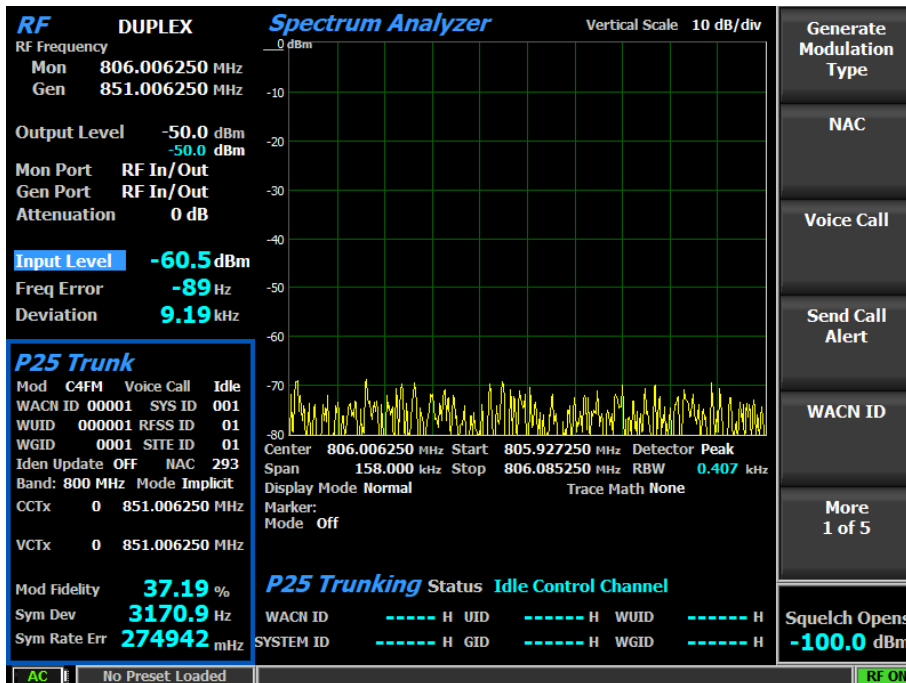

A P25 trunked radio connected to the R8200 and activated automatically registers with the analyzer if the Band Plan settings are configured for the system under test. The registration progress is shown in the METER Zone Status field, and the radio ID parameters are populated on the display, as shown below.



Once the radio is registered (see above), a voice test using the Voice Loop feature can be performed. Keying the radio under test transitions it to the voice channel, and the R8200 automatically records up to the last 10 seconds of conversation, as long as the signal is above the squelch level setting. Unlike other test modes, the Voice Loop feature is always enabled in P25 Trunk Test Mode. The maximum length of a recording is fixed at 10 seconds. The recording continues if the transmission is longer than this duration, but only the most recent is retained. When the radio is unkeyed, the R8200 initiates a voice call and replays the last recorded conversation; to play another conversation, another recording must be made. This provides a quick end-to-end test of the P25 radio transmitter and receiver. This Voice Loop feature can also be used to verify basic functionality of a P25 radio with an encrypted voice channel.

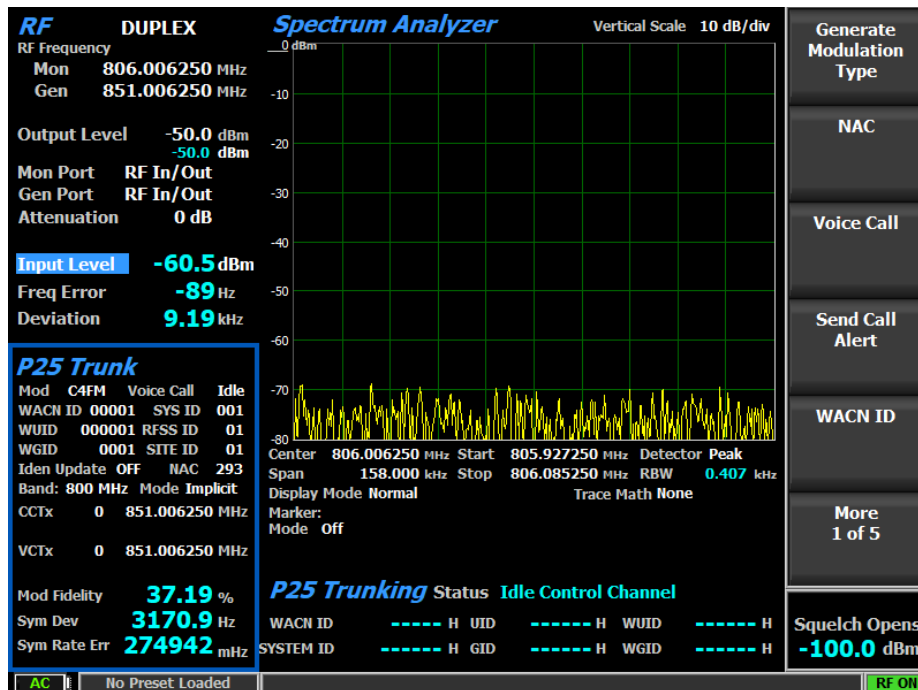

The P25 Trunk Zone offers the following measurement displays:

Mod Fidelity – Modulation Fidelity (FSK error) represents how accurate a P25 transmitter reproduces an ideal theoretical modulation waveform. The measurement is performed by first removing frequency error and symbol deviation gain error from the received signal, then computing the RMS difference between the deviation of the resulting signal at each symbol decision point and the ideal deviations of those symbols; no bit errors should be detected. On the R8200 this is computed over a 72 symbol interval and reported as an RMS error in % relative to the mean deviation across symbols.

Sym Dev – P25 radios broadcast voice and data using a four level frequency deviation of the carrier to represent symbols containing data bits as shown in the table below. The nominal deviation value for a Project 25 radio using C4FM modulation is 1800 Hz. Since the deviation of a Project 25 C4FM signal is data dependent, that aspect is factored when measuring overall carrier deviation. The Symbol Deviation field provides the deviation measurement at symbol decision times.

Bits	Symbol	Carrier Frequency Deviation
01	+3	+1800 Hz
00	+1	+600 Hz
10	-1	-600 Hz
11	-3	-1800 Hz

Sym Rate Err – The Symbol Rate Error is a measurement of the transmitter symbol rate accuracy, the difference of the actual minus the ideal. Thus, a positive error indicates that the transmitter clock is too fast. P25 standard TIA-102.CAAB-B 3.2.17 Symbol Rate Accuracy states that the symbol rate error shall not exceed 10 PPM, which is ± 48 mHz given the ideal symbol rate of 4800 baud. The measurement is designed to provide much better accuracy by continually refining the measurement over time. A Reset Symbol Rate Error soft key is provided to restart the measurement.

While the analyzer is operating in P25 Trunk Test Mode, the P25 Trunk Zone soft key menus contain all of the R8200 parameter settings for controlling the P25 Trunk physical layer. For a complete soft key reference for the P25 Trunk Zone, see ["P25 Trunk Zone Soft Keys" on page 639](#).

The DISPLAY Zone

During P25 Trunk Test Mode, the DISPLAY Zone offers the Spectrum Analyzer, Oscilloscope, Eye Diagram, and Distribution Plot, accessed by pressing **Select Display**, as shown in the horizontal soft key menu below.

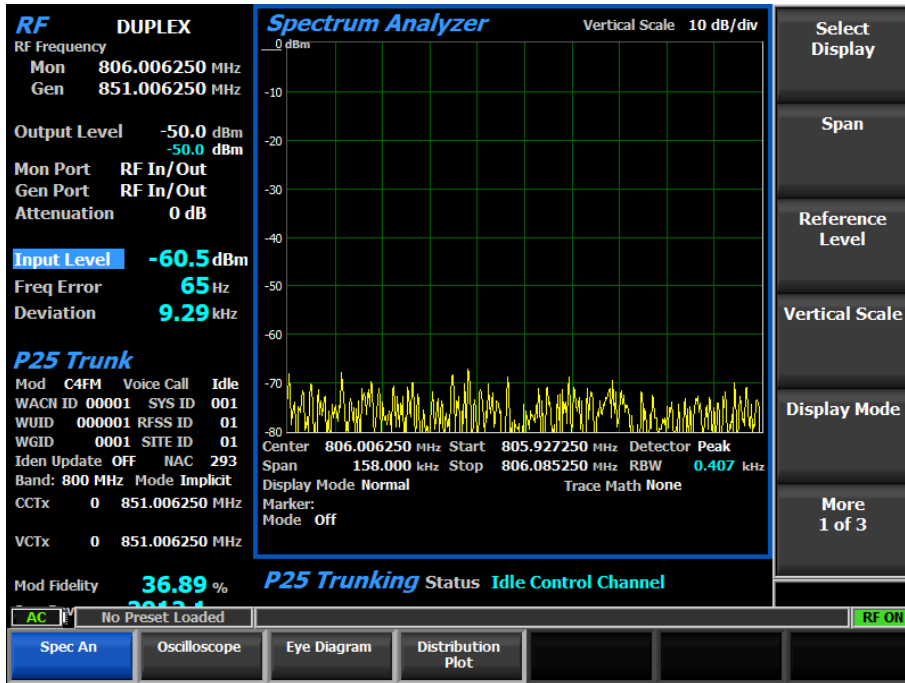

Spectrum Analyzer

See "Introducing the Spectrum Analyzer" on page 93.

Oscilloscope

See "Introducing the Oscilloscope" on page 96.

Eye Diagram

See "Eye Diagram" on page 157.

Distribution Plot

See "Introducing PROJECT 25 Test Mode" on page 168.

While the analyzer is operating in P25 Trunk Test Mode, the DISPLAY Zone soft key menus contain all of the parameter settings for RF and baseband measurement display. For DISPLAY Zone soft keys unique to P25 Trunk Test Mode, see ["DISPLAY Zone Soft Keys for P25 Trunk for Transmitter Test" on page 654](#). For a complete soft key reference for the DISPLAY Zone, see ["DISPLAY Zone Soft Keys for Duplex Mode" on page 496](#).

The METER Zone

In P25 Trunk Test Mode, the METER Zone is preloaded with a P25 Trunking Meter.

P25 Trunking Meter



<i>P25 Trunking</i>		Status	Idle Control Channel		
WACN ID	000001 H	UID	000001 H	WUID	00001 H
SYSTEM ID	0001 H	GID	0001 H	WGID	001 H

A P25 trunked radio connected to the R8200 and activated automatically registers with the analyzer if the Bandplan settings are configured for the radio under test. This meter reports the status of these P25 Trunk Bandplan registration parameters after they have been received and decoded by the R8200.

While the analyzer is operating in P25 Trunk Test Mode, the METER Zone soft key menus contain all of the parameter settings for RF and baseband measurement metering. For METER Zone soft keys unique to P25 Trunk Test Mode, see ["METER Zone Soft Keys for P25 Trunk Transmitter Test" on page 655](#). For a complete soft key reference for the METER Zone, see ["METER Zone Soft Keys for Monitor Mode" on page 401](#).

Introducing NXDN™ Test Mode

The R8200 NXDN™ Test Package option / NXDN™ Test Mode allows testing of radios compliant with the NXDN™ radio transmission protocol. NXDN™ radios use a digital transmission format employing Four-Level Frequency Shift Keying (4FSK) modulation in an RF spectrum managed by Frequency Division Multiple Access (FDMA) technology. Both 9600 bps and 4800 bps transmission rates are supported. The R8200 NXDN™ Mode provides a grouping of test functions compliant with the Conformance Test section of the NXDN™ Common Air Interface (CAI) standard. These include power, Frequency Error, Symbol Deviation, Modulation Fidelity (FSK Error), Radio Access Number (RAN), audio/test patterns, and Bit Error Rate (BER). BER tests require the manufacturer’s Radio Service Software (RSS) to place the radio in a special test mode. In addition, an Eye Diagram with graphical representation of the NXDN™ signal exists as well as a Voice Loopback function that enables the Voice Loop feature (U.S. patent 5703479) for audio verification of the radio’s end-to-end operation. Both provide qualitative indication of the radio’s performance. Averaging can be applied to some measurements by the System Settings.



Pressing **Test > Test Mode > NXDN™** configures the R8200 for NXDN™ protocol testing, as shown above. On the R8200 main display, the Standard mode’s AUDIO Zone and associated soft keys are replaced by the NXDN™ Zone and NXDN™-specific soft keys (accessed by pressing the **NXDN™** soft key).

The RF Zone

In NXDN™ Test Mode, the RF Zone displays parameters associated with the NXDN™ carrier stimulus generated by the R8200 as well as measurements of the RF transmissions received from the radio under test. The RF Zone during NXDN™ transmitter testing (with the R8200 in Monitor Mode) is shown on the left while the RF Zone during NXDN™ receiver testing (with the R8200 Generate Mode) is shown on the right, below.

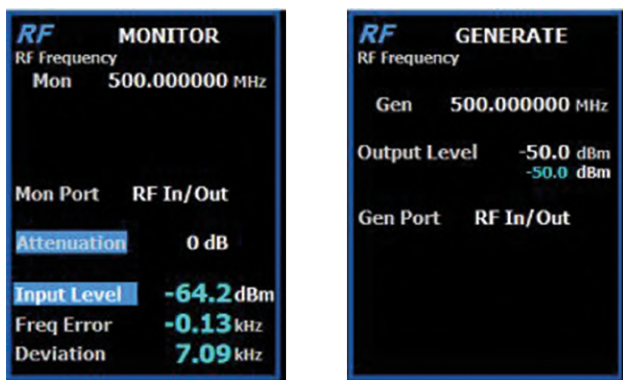

During NXDN™ Test Mode, the RF Zone offers the following measurement displays:

Input Level – Displays the average power in the NXDN™ channel under test.

NOTE

When the RF input power on the RF In/Out port is above +20 dBm (100 mW), the R8200 utilizes a broadband power detector for the measurement. The Input Level field in the RF Zone changes to Watt Meter to indicate this measurement mode. For best accuracy, disable the Pre-amplifier in Monitor Mode and set the Gen Port in Generate Mode to RF In/Out.

Freq Error – Displays the frequency difference of the received NXDN™ transmission carrier minus the R8200 Monitor Frequency.

Deviation – Displays the positive peak FM frequency deviation of the received modulated carrier (i.e., from the Frequency Error mean). See negative peak frequency deviation with DISPLAY Zone Bar Graphs.

While the analyzer is operating in NXDN™ Test Mode, the RF Zone soft key menus contain all of the parameter settings for the controlling the R8200 RF output. For a complete soft key reference for the RF Zone, see "[RF Zone Soft Keys for Generate Mode](#)" on page 412.

The NXDN™ Zone

While operating in NXDN™ Test Mode, the AUDIO Zone and AUDIO Zone soft keys are replaced by the NXDN™ Zone and NXDN™ specific soft keys. The NXDN™ Zone displays the physical layer parameters that can be configured to encode and decode NXDN™ content. The NXDN™ Zone is shown in Monitor Mode on the left and Generate Mode on the right, below.



The NXDN™ Zone offers the following measurement displays:

RAN – Radio Access Number is a six-bit field for the NXDN™ conventional system protocol of the RTCH/RDCH frame in the SACCH field. The R8200 analyzes all NXDN™ transmissions regardless of the transmitted number. See **"NXDN™ Zone Soft Keys" on page 656** for more details.

Sym Dev – Provides the deviation measurement at symbol decision times. NXDN™ radios broadcast voice and data using a four-level frequency deviation of the carrier to represent symbols containing data bits as shown in the table below. The nominal symbol deviation value for an NXDN™ radio using 4FSK modulation is 1050 Hz in a 6.25 kHz channel and 2400 Hz in a 12.5 kHz channel. Since the deviation of an NXDN™ 4FSK signal is data dependent, that aspect is factored when measuring overall carrier deviation.

The NXDN48 (4800 bps) Mode ideal is 1050 Hz and the NXDN96 (9600 bps) Mode ideal 2400 Hz.

Bits	Symbol	NXDN48 (4800 bps) Mode Frequency Deviation	NXDN96 (9600 bps) Mode Frequency Deviation
01	+3	+1050 Hz	+2400 Hz

Bits	Symbol	NXDN48 (4800 bps) Mode Frequency Deviation	NXDN96 (9600 bps) Mode Frequency Deviation
00	+1	+350 Hz	+800 Hz
10	-1	-350 Hz	-800 Hz
11	-3	-1050 Hz	-2400 Hz

Mod Fidelity – Modulation Fidelity (FSK error) represents how accurate a transmitter reproduces an ideal theoretical modulation waveform. The measurement is performed by first removing frequency error and symbol deviation gain error from the received signal, then computing the RMS difference between the deviation of the resulting signal at each symbol decision point and the ideal deviations of those symbols; no bit errors should exist. On the R8200, this is reported as an RMS error in % relative to the mean deviation across symbols.

BER – Percentage of bit differences between the bits of the selected Test Pattern and the bits from the received synchronized FDMA signal are shown in this field. BER measures the modulation, encoding, and timing of the transmit signal during the data transmission period. When performing the BER Test, the radio transmitter under test must be placed into a test diagnostic mode with the correct TX test pattern selected using the manufacturer’s Radio Service Software (RSS). The test is done at nominal power with the radio transmitting the test pattern into the service monitor. Placing an attenuator between the radio under test and the service monitor is acceptable.

While the analyzer is operating in NXDN™ Test Mode, the NXDN™ Zone soft key menus contain all of the R8200 parameter settings for the controlling the NXDN™ physical layer. For a complete soft key reference for the NXDN™ Zone, see "[NXDN™ Zone Soft Keys for Transmitter Test](#)" on page 657.

The DISPLAY Zone

During NXDN™ Test Mode, the DISPLAY Zone offers a Spectrum Analyzer, Modulation Scope, Oscilloscope, Bar Graphs, and an Eye Diagram, accessed by pressing **Select Display**, as shown in the horizontal soft key menu below.

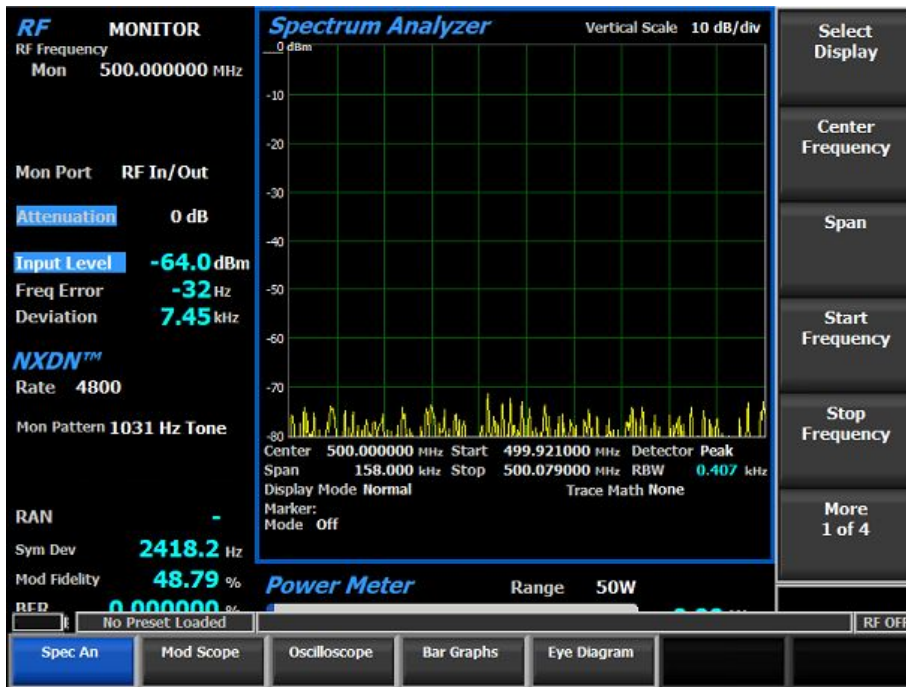

Spectrum Analyzer

See "Introducing the Spectrum Analyzer" on page 93.

Modulation Scope

See "Introducing the Modulation Scope" on page 95.

Oscilloscope

See "Introducing the Oscilloscope" on page 96.

Bar Graphs

See "Bar Graphs" on page 80.

Eye Diagram

See "Eye Diagram" on page 157.

While the analyzer is operating in NXDN™ Test Mode, the DISPLAY Zone soft key menus contain all of the parameter settings for RF and baseband measurement display. For DISPLAY Zone soft keys unique to NXDN™ Test Mode, see **"DISPLAY Zone Soft Keys for NXDN™ Transmitter Test" on page 660**. For a complete soft key reference for the DISPLAY Zone, see **"DISPLAY Zone Soft Keys for Duplex Mode" on page 496**.

The METER Zone

In NXDN™ Test Mode, the METER Zone is preloaded with a Power Meter.

A Voltmeter and RF Scan are also available by pressing **Hot Key 5 > Select Meter** and choosing the desired selection, as shown below.

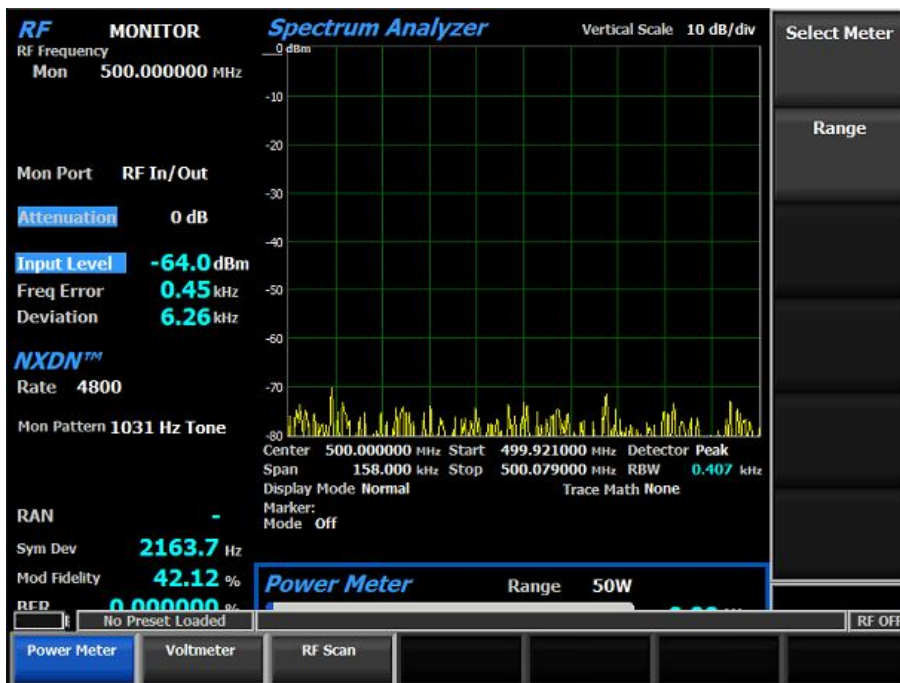

Power Meter

See **"Power Meter" on page 100**.

Voltmeter

See **"Voltmeter" on page 101**.

Decoder

See ["Decoder" on page 102](#).

RF Scan

See ["RF Scan" on page 106](#).

While the analyzer is operating in NXDN™ Test Mode, the METER Zone soft key menus contain all of the parameter settings for RF and baseband measurement metering. For METER Zone soft keys unique to NXDN™ Test Mode, see ["METER Zone Soft Keys for NXDN™ Transmitter Test" on page 661](#). For a complete soft key reference for the METER Zone, see ["METER Zone Soft Keys for Monitor Mode" on page 401](#).

To learn about using the R8200 to service portables, mobiles, and system infrastructure employing the NXDN™ protocol, turn to ["Using NXDN™ Test Mode" on the next page](#).

Using NXDN™ Test Mode

This section provides an example measurement using the analyzer's NXDN™ Mode. Complete this procedure to make an initial verification of a portable radio's digital signal processing without the need for specialized power supplies, test boxes, or radio service software. It can be completed using only the radio, a single BNC cable, and two adapters.

Transceiver Verification

This section describes a simple procedure for verifying the basic functionality of the radio's RF transceiver and physical layer protocol using the R8200 in NXDN™ Mode. Follow these steps to connect the radio to the R8200 and configure your measurement.

Required Equipment

- Freedom R8200 Communications System Analyzer
- Portable Radio, programmed for NXDN™ (i.e., Kenwood, ICOM, or similar)
- Cable, coax, BNC (m-m)
- Adapter, Type N(f)-to-BNC(f)
- Adapter, SMA(f)-to-BNC(f)

Test Setup

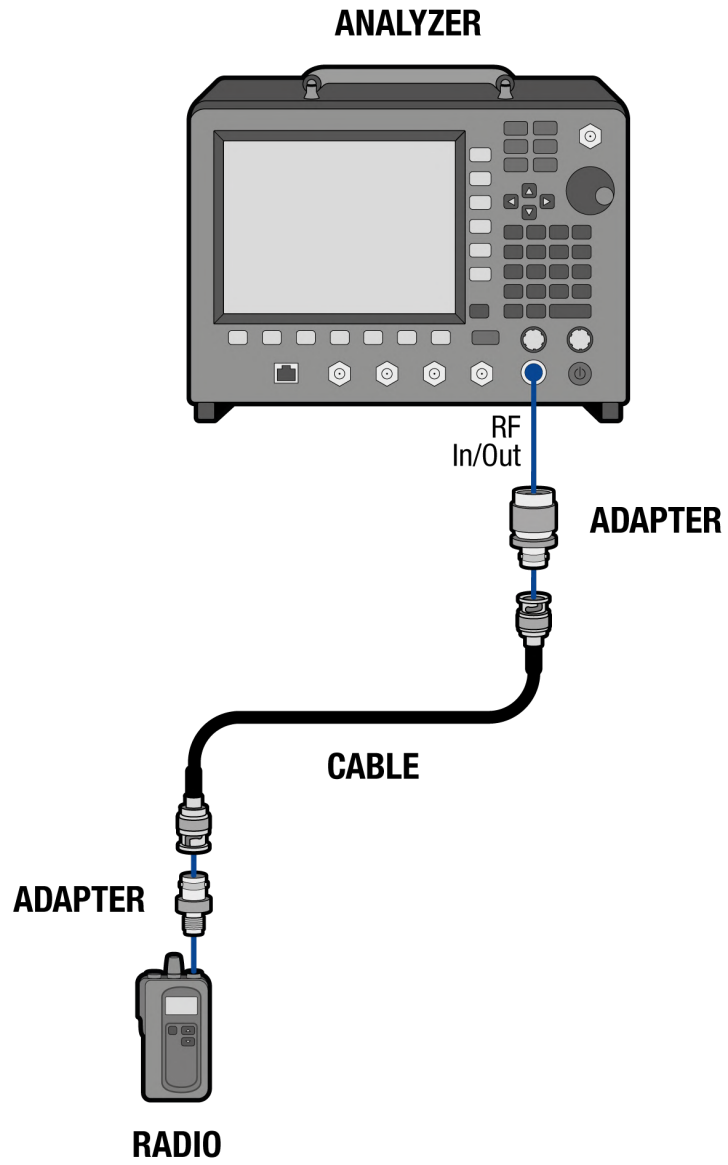

Procedure

Steps	Actions	Notes
1. Configure the test setup.	<ul style="list-style-type: none"> a. Connect the Type N(f)-to-BNC(f) adapter to the R8200's RF In/Out port. b. Remove the antenna from the radio. c. Connect the SMA(f)-to-BNC(f) Adapter to the Antenna port of the radio. d. Connect the BNC cable between the radio and the R8200. 	
2. Configure the R8200.	<ul style="list-style-type: none"> a. To access the NXDN™ Test Mode, press Test > Test Mode > NXDN. b. Press Monitor. c. To set the receiver Center Frequency to match the radio transmitter, press Hot Key 1 > Monitor Frequency > 851 > MHz. d. In the RF Zone, confirm that Mon Port displays RF In/Out as the receiver's input. 	<p>This opens the NXDN™ Test Mode display.</p> <p>Alternatively, press RF Zone > Monitor Frequency > 851 > MHz.</p> <p>If not, press Mon Port > RF In/Out > Enter.</p>
3. Activate and key the radio.	<ul style="list-style-type: none"> a. Turn the On/Off/Volume Knob clockwise to activate the radio. b. Press PTT on the portable. 	This initiates a broadcast of the voice content picked up by the radio microphone.
4. Observe the DISPLAY Zone.	<ul style="list-style-type: none"> a. Press Hot Key 2 > Select Display > Eye Diagram. 	You should observe change in the deviation of the carrier at the 4 target symbol decision times as measured in

Steps	Actions	Notes
	<ul style="list-style-type: none"> b. Confirm that the analyzer is decoding the tighter the transitions are to the “+” crossing points the better the modulator performance. 	the post detection filter.
5. Observe the RF Zone.	<ul style="list-style-type: none"> a. Confirm that the Input Level displays the radio's output as <i>approximately 3 W</i>. b. Confirm that the Freq Error displays the radio's frequency error as <i>less than 100 Hz</i>. 	This verifies the performance of the radio's RF transmitter.
6. Observe the NXDN™ Zone.	<ul style="list-style-type: none"> a. Confirm that RAN displays a valid Random Access Number. b. Confirm that Mod Fidelity displays <i>less than 1%</i>. c. Confirm that Symbol Dev displays <i>less than 2 kHz</i>. 	This verifies that the radio correctly encoding the NXDN message content. Having confirmed these transmission parameters, you can verify that the transmitter on this radio is working properly in NXDN™ Test Mode.
7. Configure the R8200.	<ul style="list-style-type: none"> a. To prepare to broadcast to the radio, press Generate. b. To set the transmitter Generate Frequency to match the radio receiver, press Hot Key 1 > Generate Frequency > 851 > MHz. c. To Copy the RAN to the Generator, press Hot Key 4 > More > Copy RAN to Generator. d. To begin transmitting RF from the R8200, press Hot Key 1 > Gen Port RF In/Out. e. To generate a standard NXDN™ 	

Steps	Actions	Notes
	test pattern, press Hot Key 4 > Gen Test Pattern > 1031 Hz Tone .	
	f. To modulate the RF carrier, press Modulation Mode > Continuous .	
8. Listen for the 1031 Hz tone broadcast from the radio's speaker.	a. Adjust the volume of the 1031 Hz tone using the radio's On/Off/Volume Knob.	This verifies that the radio correctly decodes the NXDN™ baseband content.
9. Test the sensitivity of the radio.	a. To adjust the Output Level of the R8200, press Hot Key 1 > Output Level .	
	b. Use the arrow keys and the tuning knob to decrease the Output Level until the 1031 Hz tone is no longer broadcast from the radio speaker.	
	c. Confirm that the RF Output Level on the R8200 is <i>less than -120 dBm</i> when the tone disappears.	This confirms that the radio receiver is sensitive to transmissions as weak as -120 dBm.

Having confirmed these parameters, you can verify that the transceiver on this radio is working properly in NXDN™ Test Mode.

Introducing NXDN™ Trunk Mode

The optional R8200 NXDN™ Type C Trunk Test Mode allows testing of trunked NXDN™ compliant radios. NXDN™ radios use a digital transmission format employing Continuous four level FM (C4FM) modulation. The R8200 NXDN™ Type C Trunk Mode simulates the functions of a NXDN™ central controller with the control and voice channel protocols needed for various tests. Also included are NXDN™ compliant test patterns for Bit Error Rate (BER) testing, RF Input Power, Frequency Error and Deviation measurements, a Spectrum Analyzer, Modulation Scope, Oscilloscope, and an Eye Diagram with graphical representation of the NXDN™ Trunk signal, and an NXDN™ Trunk Status meter.

A Voice Loop feature (U.S. patent 5703479) is engaged for audio verification of the radio's end-to-end operation after the subscriber unit transmits. During a Voice Call the R8200 automatically records voice channel data while the subscriber unit PTT is pressed, then retransmits it to provide audio verification of the radio's end-to-end operation.

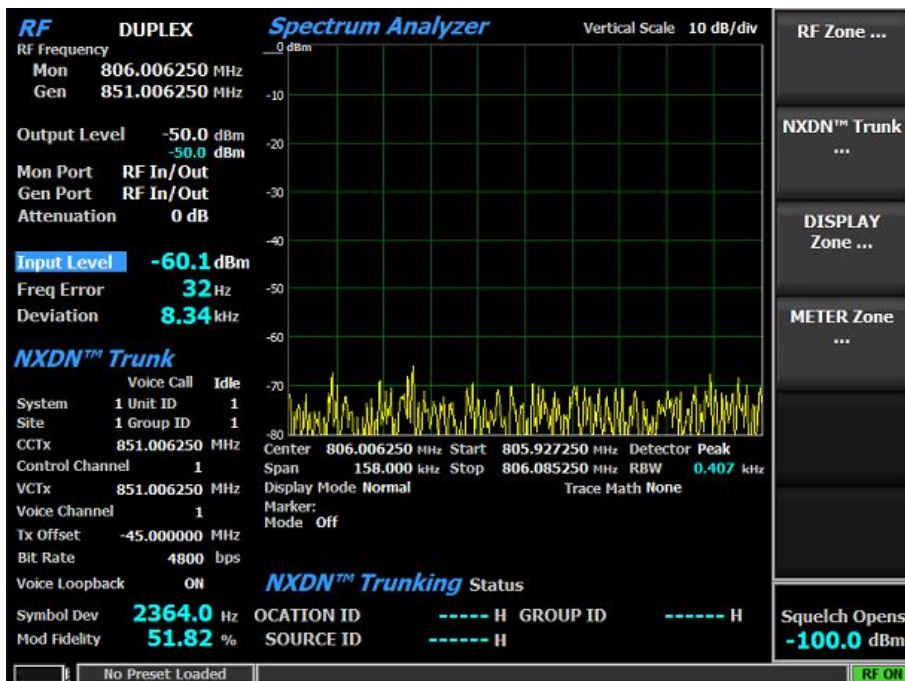

Pressing **Test > Test Mode > NXDN™ Trunk** configures the R8200 for NXDN™ Trunk Test Mode, as shown above. On the R8200 main display, the Standard mode's AUDIO Zone and associated soft keys are replaced by the NXDN™ Trunk Zone and NXDN™ Trunk-specific soft keys (accessed by pressing the **NXDN™ Trunk** soft key).

NOTE

The manufacturer's Radio Service Software (RSS) is required to perform some tests in NXDN™ Type C Trunk Mode because certain measurements (BER) require placing the radio in a special test mode.

The RF Zone

As usual, the RF Zone can be used to configure various settings such as output level, attenuation, and ports, etc. However, the soft keys for Monitor and Generate frequencies are disabled. These frequencies are determined by settings in the NXDN™ Type C Trunk Zone, either the control/voice channel frequency settings or the control/voice channel number settings according to the Band Plan Table.

NOTE

RF Zone Monitor and Generate Frequency settings can be changed for the BER Test. Otherwise, they are read-only and updated in real-time to show the control channel frequencies or the voice channel frequencies that are in use.

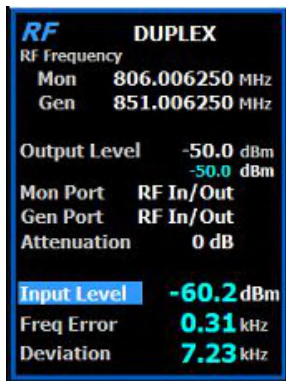

When the NXDN™ Type C Trunk Test Mode is selected, the R8200 is automatically placed in Duplex Mode and begins transmitting idle messages on the control channel with no encryption. And the RF Zone offers the following measurement displays:

Input Level – Displays the average power in the specified Burst of the synchronized TDMA slot transmitted by the radio under test.

Freq Error – Displays the difference between the received NXDN™ Trunk carrier frequency and the R8200 Monitor Frequency.

Deviation – Displays the negative and positive peak frequency deviation of a modulated carrier (i.e., from the Frequency Error mean), available when Modulation Mode is FM.

While the analyzer is operating in NXDN™ Trunk Test Mode, the RF Zone soft key menus contain all of the parameter settings for the controlling the R8200 RF output. For a complete soft key reference for the RF Zone, see "[RF Zone Soft Keys for Duplex Mode](#)" on page 462.

The NXDN™ Trunk Zone

While operating in NXDN™ Trunk Test Mode, the AUDIO Zone and associated soft keys are replaced by the NXDN™ Trunk Zone and NXDN™ Trunk specific soft keys. The NXDN™ Trunk Zone displays the physical layer parameters that can be configured to encode and decode NXDN™ Trunk content. The NXDN™ Trunk Zone is shown in Duplex Mode, below.



NXDN™ Trunk		
	Voice Call	Idle
System	1 Unit ID	1
Site	1 Group ID	1
CCTx	851.006250 MHz	
Control Channel	1	
VCTx	851.006250 MHz	
Voice Channel	1	
Tx Offset	-45.000000 MHz	
Bit Rate	4800 bps	
Voice Loopback	ON	
Symbol Dev	2225.0 Hz	
Mod Fidelity	41.30 %	

The NXDN™ Trunk Zone offers the following measurement displays:

Symbol Dev – Displays the symbol deviation estimated by averaging the normalized frequency deviations at symbol times in the specified burst of the synchronized TDMA slot of the received signal and then scaling by the maximum symbol value. The normalized frequency deviation is computed as the ratio of the actual frequency measurement at a given symbol or deviation state by the corresponding symbol value. The NXDN48 (4800 bps) Mode ideal is 1050 Hz and the NXDN96 (9600 bps) Mode ideal 2400 Hz.

Bits	Symbol	NXDN48 (4800 bps) Mode Frequency Deviation	NXDN96 (9600 bps) Mode Frequency Deviation
01	+3	+1050 Hz	+2400 Hz
00	+1	+350 Hz	+800 Hz
10	-1	-350 Hz	-800 Hz
11	-3	-1050 Hz	-2400 Hz

Mod Fidelity – Modulation Fidelity represents how accurate a transmitter reproduces an ideal theoretical modulation waveform. The measurement is performed by first removing frequency error and symbol deviation gain error from the received signal, then computing the RMS difference between the deviation of the resulting signal at each symbol decision point and the ideal deviations of those symbols; no bit errors should exist. On the R8200, this is computed over a symbol interval and reported as an RMS error in % normalized across symbols.

While the analyzer is operating in NXDN™ Trunk Test Mode, the NXDN™ Trunk Zone soft key menus contain all of the R8200 parameter settings for the controlling the NXDN™ Trunk physical layer. For a complete soft key reference for the NXDN™ Trunk Zone, see "[NXDN™ Trunk Zone Soft Keys](#)" on page 670.

The DISPLAY Zone

During NXDN™ Trunk Test Mode, the DISPLAY Zone offers a Spectrum Analyzer, Modulation Scope, Oscilloscope, and an Eye Diagram, accessed by pressing **Select Display**, as shown in the horizontal soft key menu below.

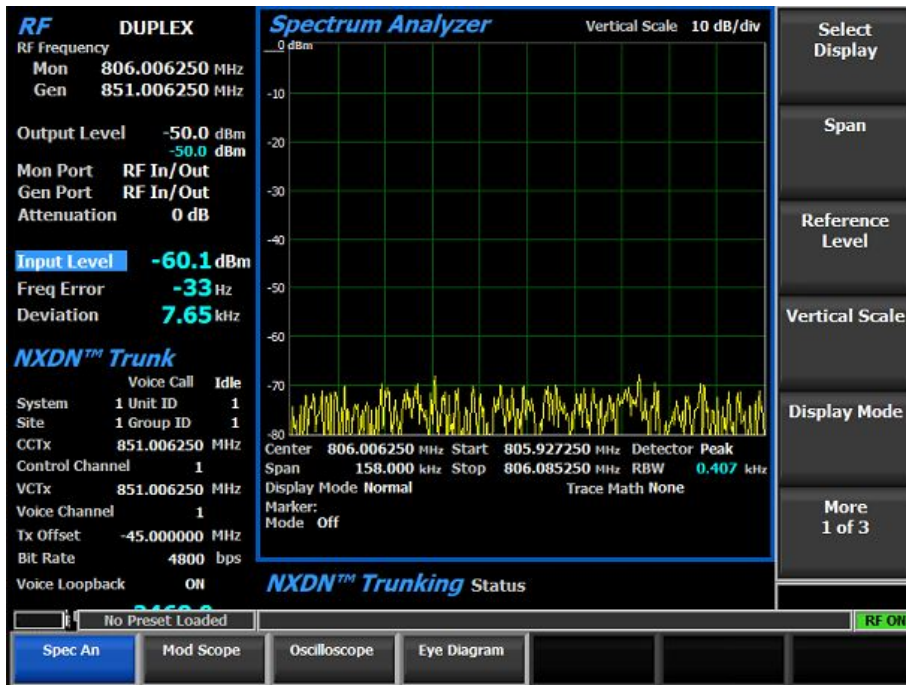

Spectrum Analyzer

See "Introducing the Spectrum Analyzer" on page 93.

Modulation Scope

See "Introducing the Modulation Scope" on page 95.

Oscilloscope

See "Introducing the Oscilloscope" on page 96.

Eye Diagram

See "Eye Diagram" on page 157.

While the analyzer is operating in NXDN™ Trunk Test Mode, the DISPLAY Zone soft key menus contain all of the parameter settings for RF and baseband measurement display. For DISPLAY Zone soft keys unique to NXDN™ Trunk Test Mode, see ["DISPLAY Zone Soft Keys for DMR Transmitter Test" on page 601](#). For a complete soft key reference for the DISPLAY Zone, see ["DISPLAY Zone Soft Keys for Duplex Mode" on page 496](#).

The METER Zone

In NXDN™ Trunk Test Mode, the METER Zone is preloaded with a NXDN™ Trunking Meter, as shown.

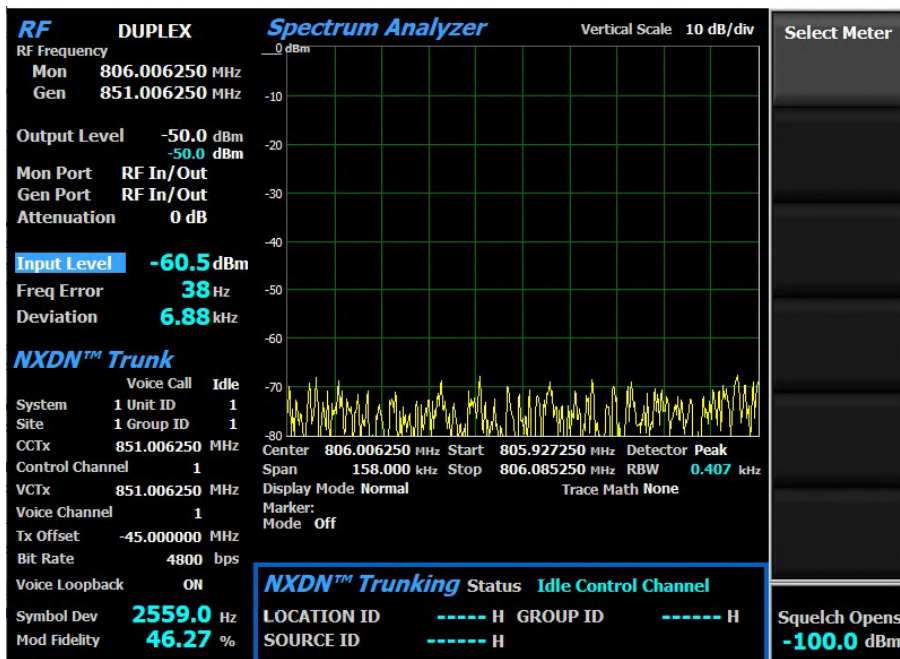

NXDN™ Trunking Status Meter

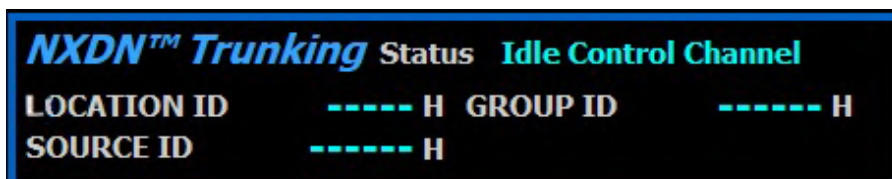

A NXDN™ Type C trunked radio connected to the R8200 and activated automatically registers with the analyzer if the Bandplan settings are configured for the system under test. The radio ID parameters are displayed in the NXDN™ Trunking Status Meter above, as the registration progresses.

For a complete soft key reference for the METER Zone, see **"METER Zone Soft Keys for Monitor Mode" on page 401**.

To learn about using the R8200 to service portables, mobiles, and system infrastructure employing the NXDN™ Trunk protocol, turn to **"Using NXDN™ Trunk Test Mode" on the next page**.

Using NXDN™ Trunk Test Mode

This section provides an example measurement using the analyzer's NXDN™ Trunk Test Mode. Complete this procedure to make an initial verification of a portable radio's digital signal processing without the need for specialized power supplies, test boxes, or radio service software. It can be completed using only the radio, a single BNC cable, and two adapters.

Transceiver Verification

This section describes a simple procedure for verifying the basic functionality of the radio's RF transceiver and ability to register to a Type C trunking system. Follow these steps to connect the radio to the R8200 and configure your measurement.

Required Equipment

- Freedom R8200 Communications System Analyzer
- Portable Radio, programmed for NXDN™ Type C Trunking
- Radio configuration information
- Cable, coax, BNC (m-m)
- Adapter, Type N(f)-to-BNC(f)
- Adapter, SMA(f)-to-BNC(f)

Test Setup

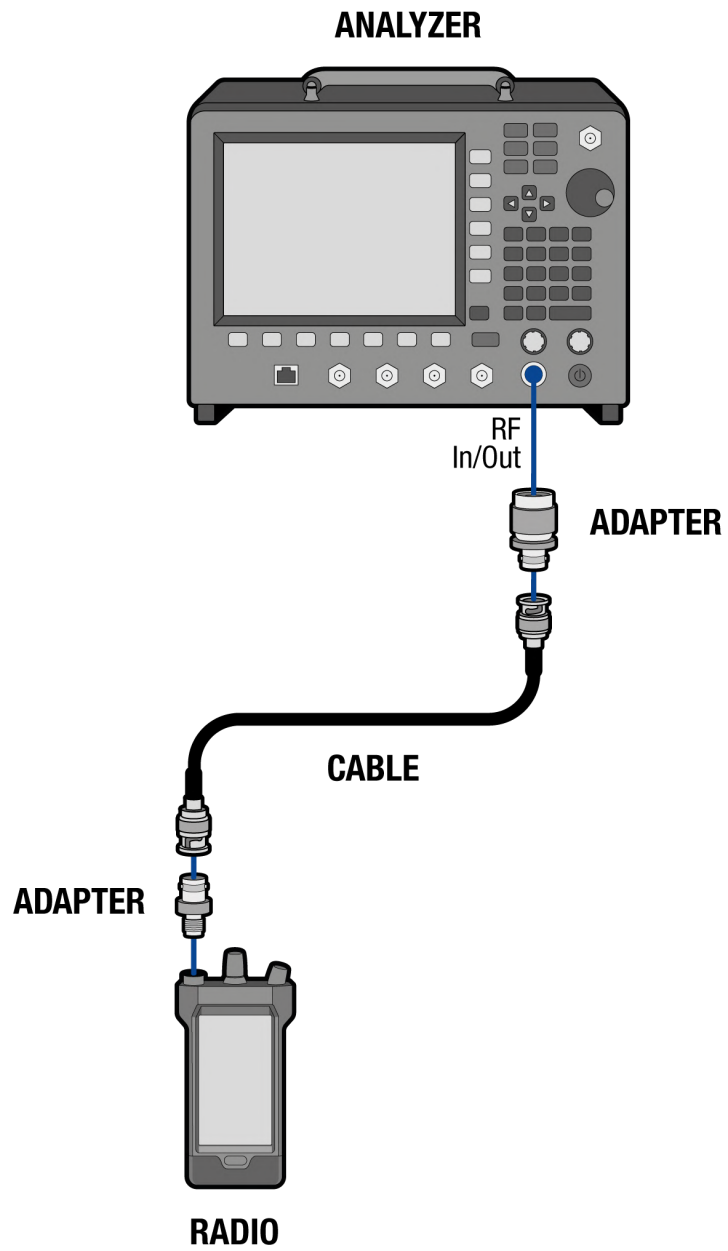

Procedure

Steps	Actions	Notes
1. Configure the test setup.	<ul style="list-style-type: none"> a. Connect the Type N(f)-to-BNC(f) adapter to the R8200's RF In/Out port. b. Remove the antenna from the radio. c. Connect the SMA(f)-to-BNC(f) Adapter to the Antenna port of the radio. d. Connect the BNC cable between the radio and the R8200. 	
2. Configure the R8200.	<ul style="list-style-type: none"> a. To deactivate Auto Attenuation, press Settings > System Settings > Automatic Attenuation > Off. b. To set manual attenuation, press Hot Key 1 > Attenuation > 36 > Enter. c. To access the NXDN™ Trunk Test Mode, press Test > Test Mode > NXDN™ Trunk. d. To configure the NXDN™ Trunk settings, press Hot Key 4. e. To set the CCTx Channel, press CCTx Channel > 1 > Enter. f. To set the VCTx Channel, press VCTx Channel > 2 > Enter. g. To set the Control Chnl TX Fre- 	<p>For a live radio Automatic attenuation often works without issue. However, for the short burst of NXDN™ signals in Trunking the delay of auto attenuation can distort the signals. The technician may find that it is better to disable auto attenuation and set a fixed value like 36 dB or more.</p> <p>Configuring the NXDN™ trunking will require knowledge of the radio channel setup, including System Code, Site Code, Unit ID, Group ID, Control Channel TX Frequency, Tx Control Channel number, Voice Channel TX Frequency, TX Voice Channel Number, TX Offset, and Bit Rate.</p>

Steps	Actions	Notes
	<p>quency, press More > Control Chnl TX Frequency > 851.05 > Enter.</p> <p>h. To set the Voice Chnl TX Frequency, press Voice Chnl TX Frequency > 860.05 > Enter.</p> <p>i. To set the Transmit Offset, press Transmit Offset > -45 > Enter.</p> <p>j. To set the System Code, press System Code > 235 > Enter.</p> <p>k. To set the Site Code, press Site Code > 1 > Enter.</p> <p>l. To set the Site Code, press Site Code > 1 > Enter.</p> <p>m. To set the Unit ID, press Unit ID > 1 > Enter.</p> <p>n. To set the Group ID, press Group ID > 1 > Enter.</p> <p>o. To set the Bit Rate, press Bit Rate > 4800 > Enter.</p>	
<p>3. Activate and key the radio.</p>	<p>a. Activate the radio and switch to appropriate channel. Wait for radio to register with UUT.</p> <p>b. When registration is complete then the METER Zone should show Location ID, Group ID and Source ID (Unit ID).</p>	
<p>4. Transmit from the radio.</p>	<p>a. Press the PTT button, and</p>	<p>If the Tone fails to start, press</p> <p>METER Zone Status will show</p>

Steps	Actions	Notes
	<p>Voice Call IN Progress.</p> <p>b. Speak into the radio while PTT is pressed.</p> <p>c. On release of PTT, wait about 5 seconds and the Voice Loop will transmit back to the radio with the voice information captured.</p> <p>d. Press Voice Call > Start.</p> <p>e. A 1031 Hz Tone will be heard from the radio speaker.</p> <p>f. Press Voice Call > Stop to end tone.</p> <p>g. Press Send Status Inquiry.</p> <p>h. Verify that the radio displays a message indicating receipt and replays the message.</p>	<p>> Voice Call > Stop. Then press PTT again until METER Zone Status reads Voice Call IN Progress. Release PTT. Try Voice call on R8200 again.</p>

Having configured and confirmed the response of the radio, you have verified that the transceiver on this radio is working properly in NXDN™ Type C Trunk Test Mode.

Introducing TETRA Base Station Test Mode

The optional R8200 TETRA Base Station Test Package option enables testing of Base Stations compliant with the ETSI Terrestrial Trunked Radio (TETRA) radio transmission protocol per ETSI specification TS 100 392 and EN 300 392. TETRA radios use a digital transmission format employing $\pi/4$ DQPSK modulation at 36000 four-bit symbols per second with Time Division Multiple Access (TDMA) with four slots per frame as its channel access methodology.

The manufacturer's Radio Service Software is not required for Base Station Monitor operation but is required to perform tests in TETRA Base Station Mode. These performance verification measurements include RF Power, RF Frequency Error, Residual Carrier Power, and EVM (RMS and Peak). In addition, the TETRA Base Station Test Mode comes equipped with Bar Charts, Spectrum Analyzer, Power Profile, and Modulation Spectrum/Constellation Displays.

Pressing **Test > Test Mode > TETRA Base Station > TETRA Base Station** configures the R8200 for TETRA Base Station Test Mode.

Options and Functionality

There are two TETRA Base Station Test options:

Option R8-TETRA_BSM (Monitor Mode) does *not* include TETRA BST Network decoding or T1 Tests.

Option R8-TETRA_BST1 (T1 Test Mode) *includes* TETRA Network decoding and T1 tests.

NOTE

The operating menus, displays, and parametric measurements are identical for both options whether OTA or by direct connections to the base station.

The functionality of the TETRA Base Station Test Mode depends on the installed options. The (R8-TETRA_BSM) Option enables the Monitor Mode with remote monitoring of a live traffic mode signal over the air. The (R8-TETRA_BST1) Option enables the T1 Test Mode with both over the air monitoring of a live traffic signal and TETRA T1 tests (BER testing) of the Transmitter and Receiver using a direct connection to the base station's RF network (i.e., the Antenna ports of the Duplexer).

NOTE

Only the (R8-TETRA_BST1) Option decodes the system network information, Mobile Country Code, Mobile Network Code, Base Station Color Code and Local Area Code.

Additionally, the base station must be under the control of the manufacturers Test Mode Software to conduct the T1 tests.

The application was designed for maximum flexibility across a variety TETRA Base Station hardware implementations. Unlike the classic Four-Zone R8000-Series display user interface, TETRA Base Station Test Mode channel assignment and baseband configuration is provided by an off-screen Channel Plan Table so that the Main Screen can be focused on displaying as many system critical measurements as possible, as shown.

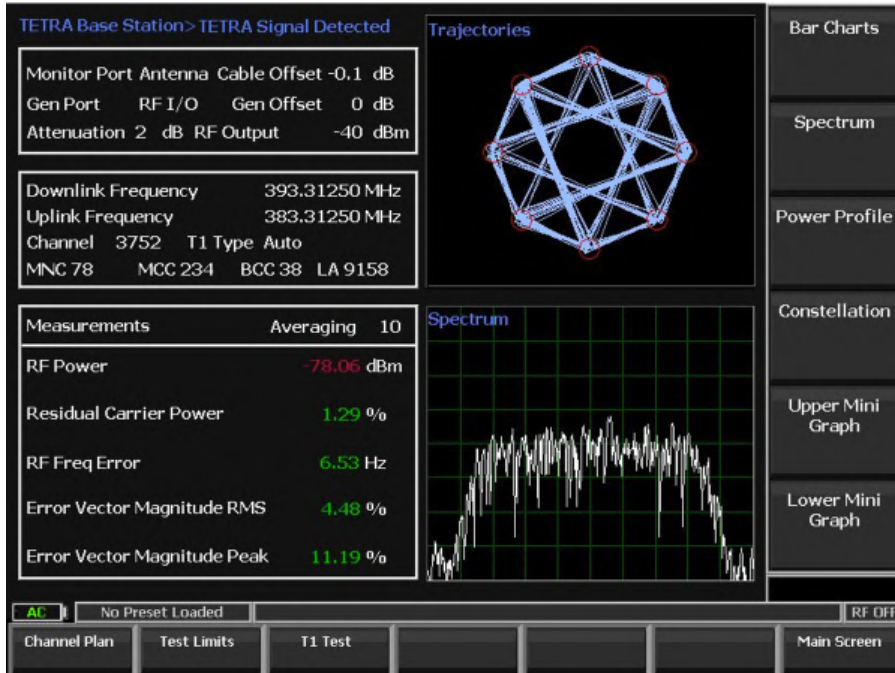

TETRA Base Station Test operating mode is determined by the installed options, each with their own display.

Monitor Mode (Option R8-TETRA_BSM) for OTA Live Monitoring

The R8200 with Option R8-TETRA_BSM enabled (operating in Monitor Mode) can execute remote monitoring of a live network's base stations. Several issues must be considered when making Over The Air (OTA) measurements. Placement of the R8200 in relation to the base station(s) to be monitored. RF Power is relative to this placement (distance) due the free space RF losses. The R8200 must receive at least -85 dBm in order to decode the transmitter para-

meters. This sensitivity is also dependent on the type of antenna employed and its height above ground or line-of-sight relationship with the base station transmitter antenna. To ensure repeatability in day to day monitoring it is important to ensure placement rules are maintained.

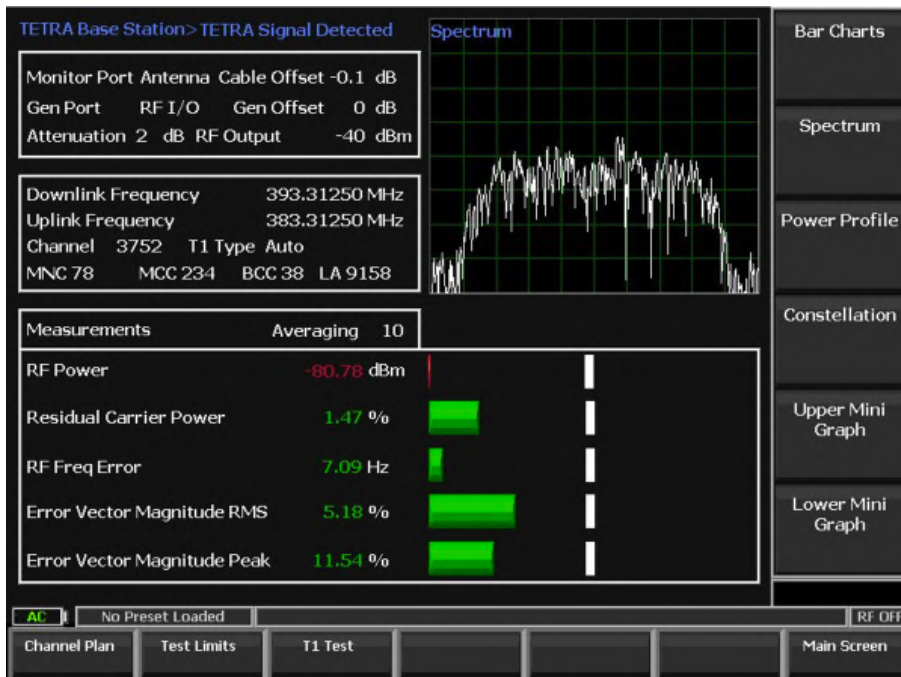

The Option R8-TETRA_BSM display features an RF Configuration Display above a Measurements Display on the left side of the screen and Mini Graphical Displays on the right side, as shown above.

TETRA Configuration Display

This area (shown above) presents the following RF and TETRA parameter settings for the receiver:

Monitor Port – Displays the current receiver port.

Pre-Amp – Displays the operating state of the Pre-Amp.

Attenuation – Displays the amount of attenuation on the receiver port.

Cable Offset – Displays the power offset compensating for cable losses associated with the transmission line connected to the receiver port.

Downlink Frequency – Displays the Monitor Frequency for the receiver.

Measurements Display

This area (shown above, beneath the RF Configuration Display) presents the following RF parameters and measurements:

Averaging – Displays the number of bursts that are averages to produce the measurement values displayed below.

RF Power – Displays the burst power level of the synchronized TDMA slot 1 transmitted by the radio under test. The measurement is done at the optimal symbol times and positions to exclude adverse effects of frequency error and residual carrier. Averaging over multiple bursts may be performed to comply with the standard. Between 1 and 250 RF power samples are collected five to 17 times per second. The number of Averaging samples can be configured by pressing the **Averaging Readings** soft key. The current number of samples is displayed as Averaging at the top of the Measurements Display. The **Reset Averaging** soft key can be pressed to zero all TETRA DMO measurements, history, and displays, including ones in other zones.

Residual Carrier Power – Displays the percentage of carrier power from inactive timeslots.

RF Freq Error – Displays the frequency difference between the received Downlink Frequency and the R8200 current Monitor Frequency setting.

Error Vector Magnitude RMS – Displays the average deviation of the actual I/Q vectors from the ideal vectors as a percentage beyond the ideal (0% Error Vector Magnitude), as depicted by the red arrow in the image below.

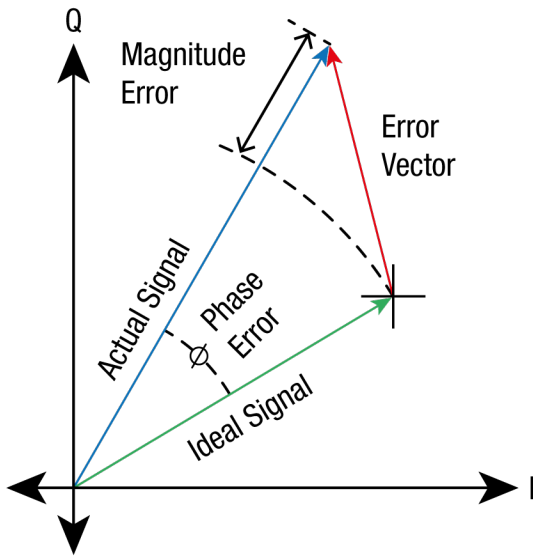

The ideal TETRA Base Station signal consists of eight decision points around the origin. From these, the deviations are measured to all actual decision points closest to each. In terms of the constellation, it is the distance from the ideal to the actual symbol. The measurement is done at the optimal symbol times and positions to exclude adverse effects of frequency error and residual carrier. The RMS error vector magnitude for a burst is the square root of the sum of the squares of the error distances divided by the number of symbols in the burst.

Error Vector Magnitude Peak – Displays the maximum error distance found over the burst as a percentage beyond the ideal (0% Peak Error Vector Magnitude).

Mini Graphical Displays

This area (shown above, on the right side of the display screen) presents a dual display of the following graphical RF measurements:

Spectrum – Displays a power-versus-frequency representation of the base station transmitted carrier signal.

Power Profile – Display provides a power versus time plot of the transmitted timeslots. This specialized Oscilloscope display is useful for ensuring that near-far situations will not result in co-channel inter-slot interference on the alternate or non-transmission slot and that the power level will be adequate for acceptable BER performance. The scaling and position of the vertical power axis can be adjusted to inspect greater range or detail. The horizontal axis can be changed to view one or both slots including the additional ramp up/down time.

Symbols – Displays the measured symbol decision points as white dots and plots them on a Constellation Display of the ideal target decision points. The red targets represent the area within the 10% EVM test limit.

Trajectories – Displays the trajectories of the symbols between decision points as blue traces on a Constellation Display of the ideal target decision points.

Bar Graphs – Displays bar graphs of the measurements represented numerically in the Measurements Display area to the right.

Graphical Displays

Full screen versions of the following instrument displays can be accessed by pressing **Graphical Displays**:

Bar Charts

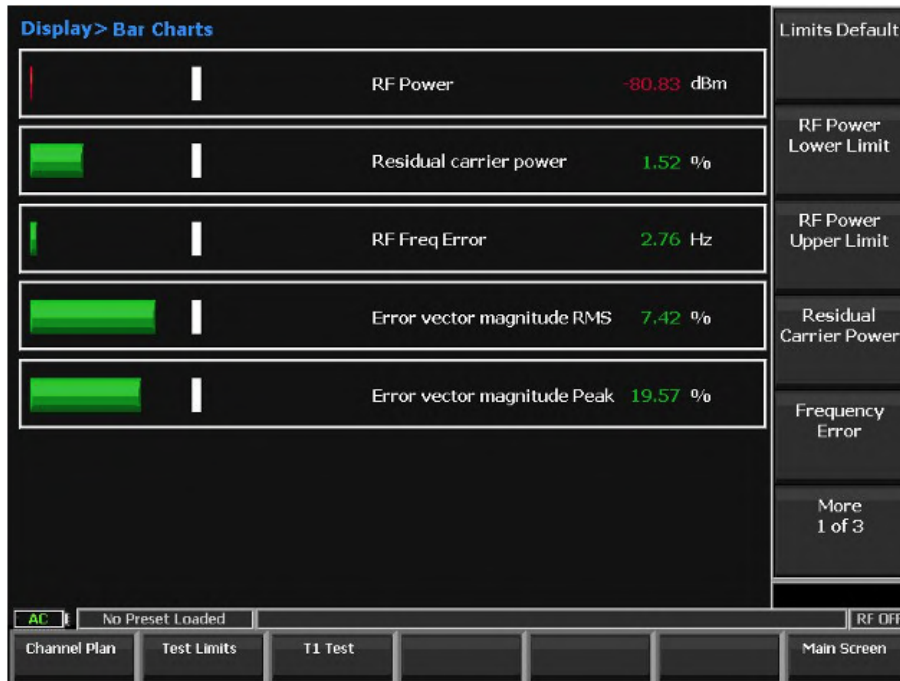

The full screen Bar Charts Display include soft keys for configuring the Test Limits of the measurements represented in the Bar Charts Display.

Spectrum Analyzer

See ["Introducing the Spectrum Analyzer" on page 93](#).

Power Profile

See ["Power Profile" on page 158](#) for additional details.

NOTE

See the Technical Specification: ETSI EN 300 396-2 "Terrestrial Trunked Radio (TETRA); Technical requirements for Direct Mode Operation (DMO); Part 2: Radio aspects," RF output power time mask.

Constellation

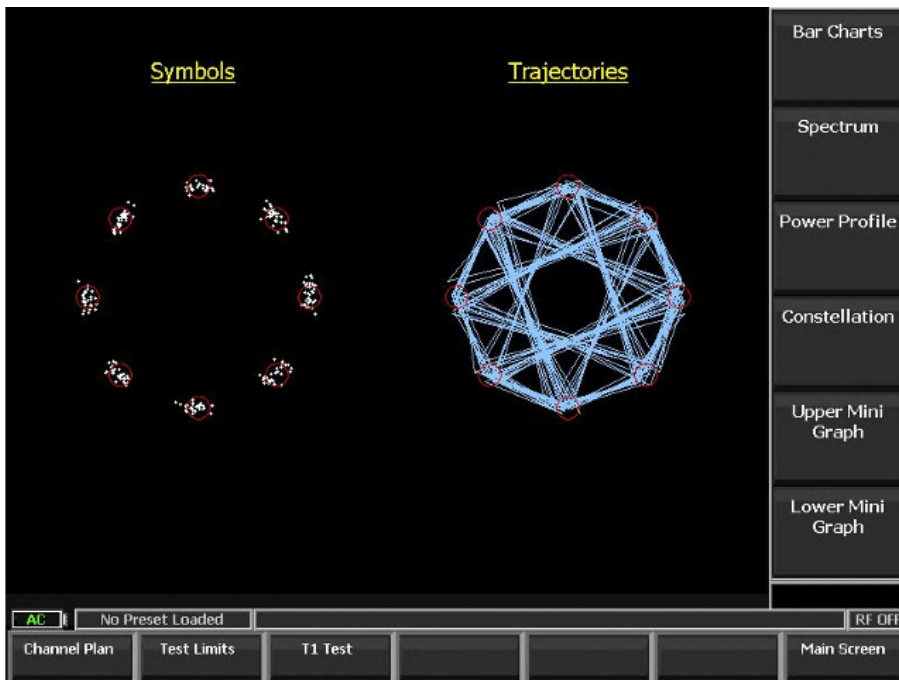

Symbols (above left) displays the measured symbol decision points as white dots and plots them on a Constellation Display of the ideal target decision points. The red targets represent the area within the 10% EVM test limit. Trajectories (above right) displays the signal path as a blue trace as it passes between decision points on a Constellation Display of the ideal targets.

Test Limits

TETRA TMO> Test Limits			Limits Default
Test Limits	Lower	Upper	
RF Power Level	43 dB	45 dB	RF Power Lower Limit
Residual Carrier Power	0 %	5 %	RF Power Upper Limit
Frequency Error	-100 Hz	100 Hz	Residual Carrier Power
RMS Vector Error	0 %	10 %	Frequency Error
Peak Vector Error	0	30 %	More 1 of 2

No Preset Loaded		RF OFF
Test Limits	TX Test	Main Screen

Pressing **Test Limits** opens the Test Limits Table (above) where you can use the vertical soft key menu to automatically configure the PASS/FAIL boundaries for every measurement in the Measurements Display. These limits are mirrored in the Bar Charts display. Pressing **Limits Default** returns all limit settings to the ETSI standard values.

TX Test

TETRA Base Station> TX Test

TX Setup

No. of Bursts for Average Calculation: 100

Measurements

	Current	Min	Max	Average
RF Power dBm	-80.306	-80.611	-79.436	-80.055
Residual Carrier Power %	1.388	0.593	2.558	1.545
Frequency Error Hz	14.504	12.651	15.521	14.386
RMS Vector Error %	4.82	4.154	10.919	6.584
Peak Vector Error %	11.392	8.658	22.377	14.658

TX Status

Burst Samples Counter: 100

Burst Samples

Start Test

Test Results

TETRALOCAL RF OFF

Test Limits TX Test Main Screen

Pressing **TX Test** opens the TX Test Table (above) where you can use the vertical soft key menu to configure your OTA performance verification of a remote Base Station. The Burst Samples setting determines the length of the test as well as the number of burst samples from which to calculate the results populating the Average column. The remaining soft keys execute the OTA transmitter test and to display the results, shown below. The transmitter test terminates when the prescribed number of samples has been gathered. See **"Measurements Display" on page 223** for an explanation of individual results.

After automatic synchronization with the Base Station via GPS standard, the TETRA Base Station T1 Mode enables the R8200 to decode and display the base station Mobile Country Code (MCC), Mobile Network Code (MNC), Base Station Color Code (BCC) and Local Area Code (Larea) as well as and provide T1 signal pattern type (typically, TCH 7.2) and BER/MER measurement results.

Unlike Monitor Mode, T1 Mode requires the generation of an Uplink signal to test the base station receiver in order to facilitate the measurement and display of the transmitter BER and MBR parameters. Each type of call can be made individually to and from the mobile.

- Ind Duplex Simultaneous TX and RX
- Ind Simplex PTT to TX
- Group PTT to TX
- Phone Simultaneous TX and RX
- SDS & DGNA Send and Receive short message, Assign and Unassign Dynamic Groups OTA
- Emergency
- Ambient Listening. Radio speaker is inhibited, Microphone is live.

All of these can be activated or deactivated using the Radio's Programming software. Call initiation and connections can be made by the MS Radio or the R8200 in Base Station T1 Test Mode.

Channel Plan Table

The Channel Plan Table displays the current T1 Test Mode Base Station configuration, as shown.

Channel System	
Uplink Frequency	380.00000 MHz
Downlink Frequency	390.00000 MHz
Channel	3600
Frequency Band	300 MHz
Channel Offset	0 Hz
Duplex Offset	10 MHz
Operating Mode	Normal
MCC	0
MNC	0
BCC	0

Use the soft keys in the T1 Test Mode vertical soft key menu to configure the RF parameters and the TETRA channeling codes.

NOTE

Failure to set these parameters correctly will result in invalid test results for TX and RX BER.

Uplink Frequency – Displays the Base Station receiver frequency.

Downlink Frequency – Displays the Base Station transmitter frequency.

Channel – Displays the Downlink Main Control (MCCH) channel number.

Frequency Band – Displays the specified harmonized Frequency Band transmitted by the R8200.

Channel Offset – Displays the current Downlink Channel Offset frequency.

Duplex Offset – Displays the current Offset Frequency for both Uplink and Downlink Channels.

Operating Mode – Displays the current forward or reverse mode of operation.

MCC – Displays the Base Station Mobile Country Code.

MNC – Displays the Base Station Mobile Network Code.

BCC– Displays the Base Station Colour Code.

T1 Test Display

The T1 Test Display presents the Base Station Test Mode Network Parameter configuration, Error Rates, Base Station T1 Information, and Test Results, as shown below for a Motorola MTS 4.

The screenshot shows the T1 Test Display interface with the following sections:

- Detected Base Station Mode > T1 Test Running**
- Network Parameters:**

Downlink Frequency	390.00000 MHz	Channel	3600	MNC	0	BCC	1
Uplink Frequency	380.00000 MHz	RF Level	-40 dBm	MCC	0	LA	0
- Error Rates:**

Downlink BER	---,--- %
Downlink MBR	---,--- %
Uplink BER	---,--- %
Uplink MER	---,--- %
- BS T1 Information:**

Mode	Manual Receive
Type	TCH/7.2
Loopback	
Codec Tones	800 Hz
- Test Results:**

	Current	Min	Max	Average
RF Power dBm	0	0	0	0
Residual Carrier Power %	0	0	0	0
Frequency Error Hz	0	0	0	0
RMS Vector Error %	0	0	0	0
Peak Vector Error %	0	0	0	0
- Bottom Bar:** AC, No Preset Loaded, RF OFF, Channel Plan, Test Limits, T1 Test, Main Screen

Network Parameters

This area (shown above, top) presents the following network parameter settings for the base station transceiver:

Downlink Frequency – Displays the Base Station transmitter frequency.

Uplink Frequency – Displays the Base Station receiver frequency.

Channel – Displays the Downlink Main Control (MCCH) channel number.

RF Level – Displays the RF output level of the Uplink signal transmitted by the R8200.

MNC – Displays the Base Station Mobile Network Code.

MCC – Displays the Base Station Mobile Country Code.

BCC – Displays the Base Station Colour Code.

LA – Displays the Larea Code.

Error Rates

This area (shown above, middle left) presents the following digital error rates for the base station transceiver:

Downlink BER – Displays the measured bit error rate percentage for the Downlink Channel.

Downlink MBR – Displays the Base Station receiver frequency.

Uplink BER – Displays the measured bit error rate percentage for the Uplink Channel.

Uplink MER – Displays the measured maximum bit rate percentage for the Uplink Channel.

BS T1 Information

This area (shown above, middle right) presents the following T1 parameter configurations for the base station transceiver:

Mode – Displays the Uplink Signal ETSI Specified Test Mode.

Type – Displays the operating state of the Uplink Signal ETSI Specified Test Pattern.

Loopback – Displays the operating state of the Voice Loopback function.

CODEC Tones – Displays the selected CODEC tone to transmit when Voice Loopback is activated.

Test Results

This area (shown above, middle right) presents the following T1 parameter configurations for the base station transceiver:

RF Power dBm – Displays the burst power level of the synchronized TDMA slot 1 transmitted by the base radio under test. The measurement is done at the optimal symbol times and positions to exclude adverse effects of frequency error and residual carrier. Averaging over multiple bursts may be performed to comply with the standard. Between 1 and 250 RF power samples are collected five to 17 times per second. The number of Averaging samples can be configured by pressing the **Averaging Readings** soft key. The current number of samples is displayed as Averaging at the top of the Measurements Display. The **Reset Averaging** soft key can be pressed to zero all TETRA DMO measurements, history, and displays, including ones in other zones.

Residual Carrier Power % – Displays the percentage of carrier power lost to demodulation error.

RF Freq Error – Displays the frequency difference between the received Downlink Frequency and the R8200 current Monitor Frequency setting.

Error Vector Magnitude RMS – Displays the average deviation of the actual I/Q vectors from the ideal vectors as a percentage beyond the ideal (0% Error Vector Magnitude), as depicted by the red arrow in the image below.

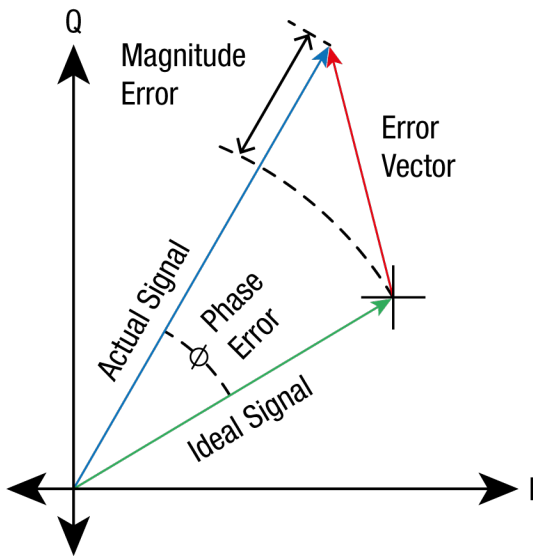

The ideal TETRA Base Station signal consists of eight decision points around the origin. From these, the deviations are measured to all actual decision points closest to each. In terms of the constellation, it is the distance from the ideal to the actual symbol. The measurement is done at the optimal symbol times and positions to exclude adverse effects of frequency error and residual carrier. The RMS error vector magnitude for a burst is the square root of the sum of the squares of the error distances divided by the number of symbols in the burst.

Error Vector Magnitude Peak – Displays the maximum error distance found over the burst as a percentage beyond the ideal (0% Peak Error Vector Magnitude).

While the analyzer is operating in TETRA Base Station T1 Test Mode, its soft key menus contain all of the R8200 parameter settings for the configuring the Base Station Channel Plan. For a complete soft key reference for the TETRA DMO Zone, see **"TETRA Base Station T1 Mode Soft Keys" on page 690**.

To learn about using the R8200 to service portables, mobiles, and system infrastructure employing the TETRA DMO protocol, turn to **"Using TETRA Base Station Test Mode" on the next page**.

Using TETRA Base Station Test Mode

This section provides two example measurements using the analyzer's TETRA Base Station Test Mode. Complete this procedure to make an initial verification of a Base Station's online Over-The-Air (OTA) performance using Monitor Mode, followed by an offline evaluation of its T1 performance. The T1 performance verification require the use of the manufacturer's Base Station Test Software.

Base Station OTA and T1 Verification

This section describes a simple procedure for verifying the basic online OTA functionality of a Motorola MTS4 base station. This is followed by an offline physically connected verification of its T1 performance which requires the use of the manufacturer's Base Station Test Software. Three test setups are provided. The first is a simple OTA setup with an antenna connected to the Antenna port. The second Test Setup shows you how to connect directly to the base station, the third depicts how to connect to the base station through its combiner/duplexer. These examples test a Motorola MTS4 base station. For the physically connected T1 tests, use the test setup that best fits your particular situation. Follow these steps to connect the network hardware to the R8200 and configure your measurement.

Required Equipment

- Freedom R8200 Communications System Analyzer
- TETRA Base Station (i.e., MTS4, MTS2, MTSLite)
- Antenna, VHF, BNC(m)
- (3) Cables, coax, BNC (m-m)
- Adapter, Type N(f)-to-BNC(f)
- Adapter, SMA(m)-to-BNC(f)
- LAN Cable

Test Setup 1

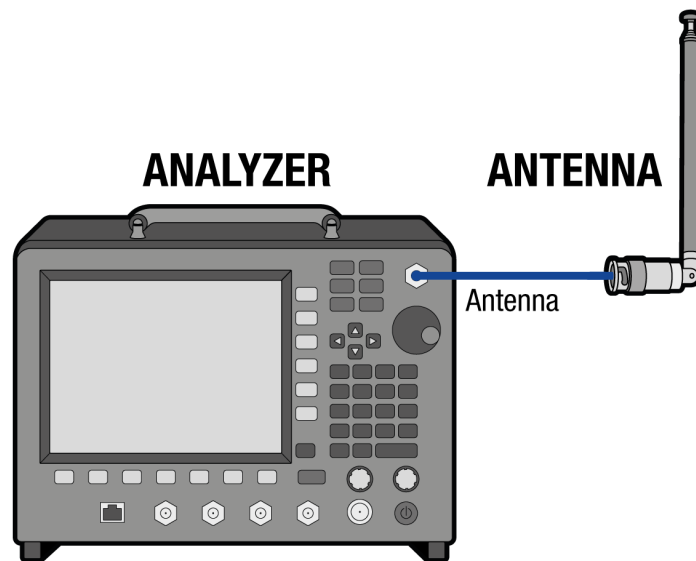

Test Setup 2

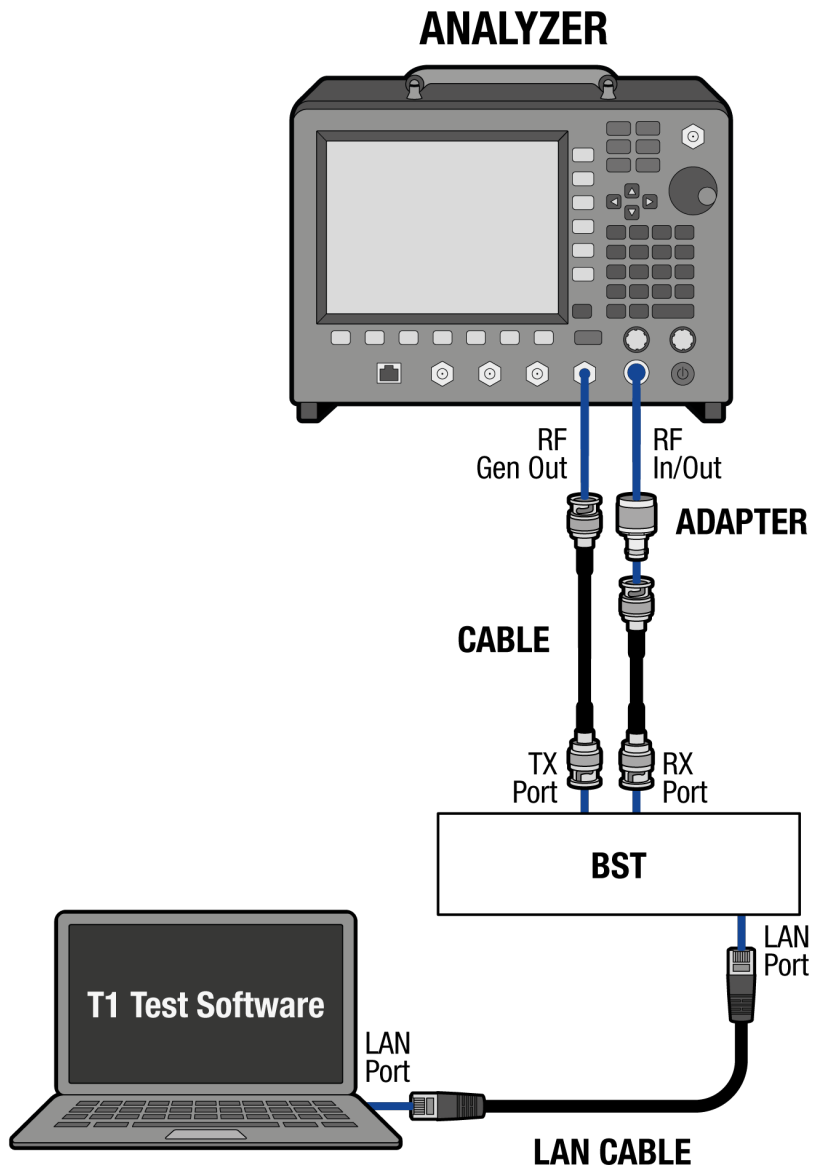

Test Setup 3

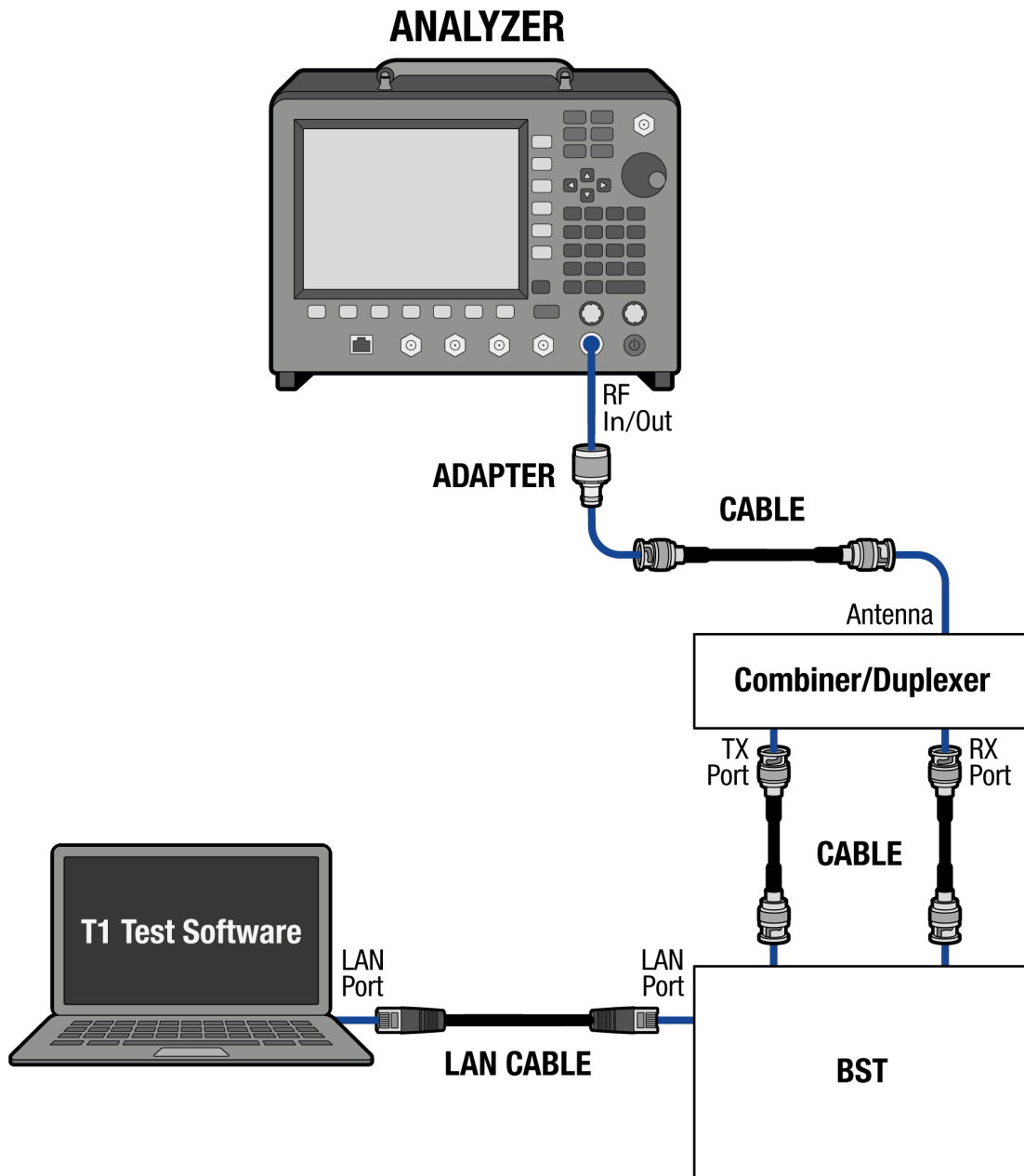

Procedure

Steps	Actions	Notes
1. Configure Test Setup 1 for an online OTA verification of base station performance.	<ol style="list-style-type: none"> a. Activate the R8200. b. Connect the antenna to the R8200 Antenna port. 	
2. Configure the R8200.	<ol style="list-style-type: none"> a. Press Test > Test Mode > TETRA Base Station > TETRA Base Station. b. To select the Antenna port as the receiver input, press More > Monitor Port > Antenna. c. To reduce the attenuation, press Attenuation > 0 dB. d. To add gain to the OTA signal, press Pre-Amp > On. e. To center the TETRA carrier on the Spectrum Analyzer display, press Downlink Frequency, enter the actual downlink frequency, and press Enter. 	This will open the Main Screen display for TETRA Base Station Test Mode and place the R8200 in Monitor Mode.
3. Observe the Measurements Display.	<ol style="list-style-type: none"> a. Verify RF Power is within test limits. b. Verify Residual Carrier Power is <i>less than 5 %</i>. c. Verify RF Freq Error is <i>less than 100 Hz</i>. d. Verify Error Vector Magnitude (RMS) is Power is <i>less than 10 %</i>. 	RF Power will depend on distance from base station Antenna. The R8200 sensitivity for decoding TETRA parameters is typically –85 dBm and is dependent on the type of antenna employed and the service monitor's line-of-sight relationship with the transmitting antenna. To ensure repeatability in day-to-day monitoring, it is important to maintain

Steps	Actions	Notes
	<ul style="list-style-type: none"> e. Verify Error Vector Magnitude (Peak) is <i>less than 30 %</i>. 	<p>a consistent spatial relationship between the service monitor and the base station antenna.</p> <p>Positive test results confirm the OTA performance of the base station under test.</p>
<p>4. To verify offline T1 base station performance, configure Test Setup 2 or 3, according to your particular situation.</p>	<ul style="list-style-type: none"> a. Collect the required adapters and cabling to connect the base station to the R8200. b. Connect the base station to the R8200. 	
<p>5. Place the base station under control of the OEM base station test software.</p>	<ul style="list-style-type: none"> a. Make the appropriate Ethernet connection between the PC and the base station. b. Run the Base Station Test Software and assume control over the base station. c. Follow the OEM instructions to set up a T1 test and place the base station in transmit mode. 	
<p>6. Configure the R8200.</p>	<ul style="list-style-type: none"> a. Press Test Mode > T1 Mode > Enter. b. To select the RF In/Out port as the receiver input, press More > Monitor Port > RF In/Out. c. To reduce the attenuation, press Attenuation > 30 dB. d. To set the RF Output Level, press More > RF Output Level > -10 > Enter. 	<p>This will open the Main Screen display for TETRA Base Station Test Mode and place the R8200 in Monitor Mode.</p>

Steps	Actions	Notes
	<ul style="list-style-type: none"> e. To trigger the verification, press T1 Test > BS OEM > Motorola MTS4 > Enter. 	
7. Observe the Measurements Display.	<ul style="list-style-type: none"> a. Verify RF Power is within test limits. b. Verify Residual Carrier Power is <i>less than 5 %</i>. c. Verify RF Freq Error is <i>less than 100 Hz</i>. d. Verify Error Vector Magnitude (RMS) is Power is <i>less than 10 %</i>. e. Verify Error Vector Magnitude (Peak) is Power is <i>less than 30 %</i>. 	
8. Use the OEM Test Software to test Downlink BER and MBR.	<ul style="list-style-type: none"> a. To set the R8200 RF Output Level, press More > RF Output Level > -116.5 > Enter. b. Verify Downlink BER and MBR are within test limits. c. Verify Uplink BER and MER are within test limits. 	
9. Observe the Error Rates display on the R8200.	<ul style="list-style-type: none"> a. Verify Downlink BER and MBR are within test limits. b. Verify Uplink BER and MER are within test limits. 	Positive test results confirm the off-line T1 performance of the base station under test.

Having confirmed these parameters, you can verify that the transceiver on this base station is working properly in TETRA Base Station Monitor and T1 modes.

Introducing TETRA DMO Test Mode

The optional R8200 TETRA DMO Test Package option / TETRA DMO Test Mode allows testing of radios compliant with the ETSI Terrestrial Trunked Radio (TETRA) Direct Mode Operation (DMO) radio transmission protocol per ETSI specification EN 300 396-2 Terrestrial Trunked Radio (TETRA); Technical requirements for Direct Mode Operation (DMO); Part 2: Radio aspects.

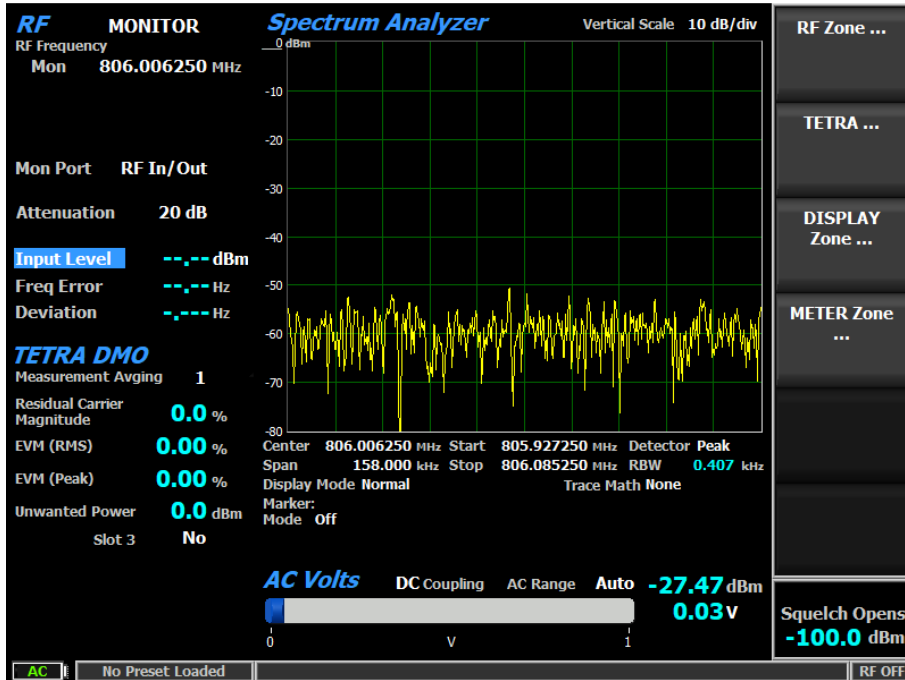

Pressing **Test > Test Mode > TETRA DMO** configures the R8200 for TETRA DMO Test Mode, as shown above. On the R8200 main display the Standard Mode's AUDIO Zone and associated soft keys are replaced by a TETRA DMO soft key and TETRA DMO-specific soft keys (accessed by pressing the **TETRA DMO** soft key).

TETRA radios use a digital transmission format employing $\pi/4$ DQPSK modulation at 18000 four-bit symbols per second with a channel access method of Time Division Multiple Access (TDMA) technology with four slots per frame. The R8200 TETRA DMO Test Mode provides test functions compliant with the ETSI specification EN 300 396. The manufacturer's Radio Service Software (RSS) is not required to perform tests in TETRA Mode. These include Slot

Power, Frequency Error, Residual Carrier Magnitude, EVM (RMS), EVM (Peak), and Unwanted Power. In addition, the TETRA DMO Test Mode is equipped with a Spectrum Analyzer, Power Profile, and Modulation Spectrum/Constellation Displays.

The RF Zone

In TETRA DMO Test Mode, the RF Zone displays parameters associated with the TETRA DMO carrier stimulus generated by the R8200 as well as measurements of the RF transmissions received from the radio under test. The RF Zone during TETRA DMO transmitter testing with the R8200 in Monitor (below left) and Duplex Mode (below right), while the RF Zone during TETRA DMO receiver testing (with the R8200 in Generate Mode) is shown in the center below.

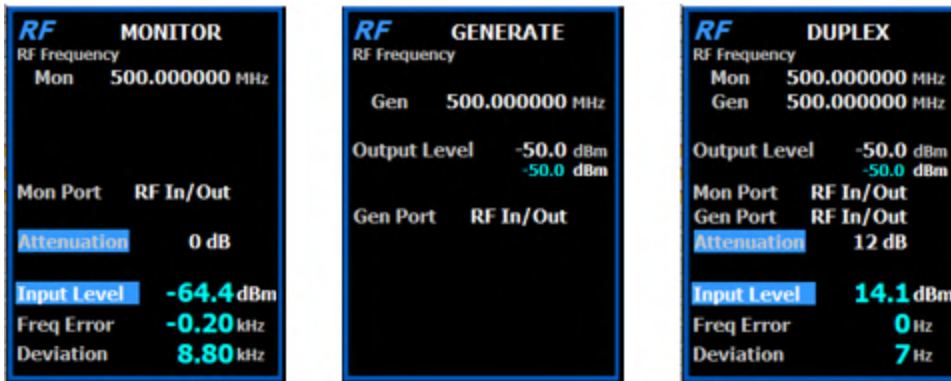

During TETRA DMO Test Mode, the RF Zone offers the following measurement displays:

Input Level – Displays the burst power level of the synchronized TDMA slot 1 transmitted by the radio under test. The measurement is done at the optimal symbol times and positions to exclude adverse effects of frequency error and residual carrier. Averaging over multiple bursts may be performed to comply with the standard. Between 1 and 250 RF power samples are collected five to 17 times per second. The number of Averaging samples can be configured by pressing the **Averaging Samples** soft key. The current number of samples is displayed as Measurement Avging at the top of the TETRA DMO Zone. The **Reset Averaging** soft key can be pressed to zero all TETRA DMO measurements, history, and displays, including ones in other zones.

NOTE

Although Input Level is used for Squelch, Squelch has no effect on measurement updates.

When the RF input power on the RF In/Out port is above +20 dBm (100 mW), the R8200 utilizes a broadband power detector for the measurement. The Input Level field in the RF Zone changes to Watt Meter to indicate this measurement mode. For best accuracy, disable the Pre-amplifier in Monitor Mode and set the Gen Port in Generate Mode to RF In/Out.

Watt Meter – Displays the level of broadband power applied to the RF In/Out port when the RF input power on the RF In/Out port is above +20 dBm (100 mW).

NOTE

A TETRA TDMA transmission alternates between a used and unused time slot, so the RF Zone field will switch between them. Unused slots have no power, so the display will flash between Input Level and Watt Meter. In this condition, the Input Level reading should be used since null slots can cause the Watt Meter indication to read approximately 6 dB less than the power in the used slots.

Freq Error – Displays the difference between the received TETRA DMO carrier frequency and the R8200 Monitor Frequency refined over numerous bursts for improved accuracy. The measurement is performed at optimal symbol times.

Deviation – Displays the negative and positive peak frequency deviation of a modulated carrier (i.e., from the Frequency Error mean), available when Modulation Mode is FM.

While the analyzer is operating in TETRA DMO Test Mode, the RF Zone soft key menus contain all of the parameter settings for the controlling the R8200 RF output. For a complete soft key reference for the RF Zone, see "[RF Zone Soft Keys for Duplex Mode](#)" on page 462.

The TETRA DMO Zone

While operating in TETRA DMO Test Mode, the AUDIO Zone and AUDIO Zone soft keys are replaced by the TETRA DMO Zone and TETRA DMO specific soft keys. The TETRA DMO Zone displays the physical layer parameters that can be configured to encode and decode TETRA DMO content. The TETRA DMO Zone is shown in Monitor Mode on the left, Generate Mode on the right, below.

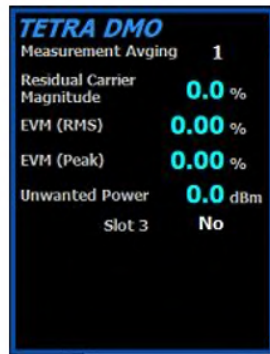
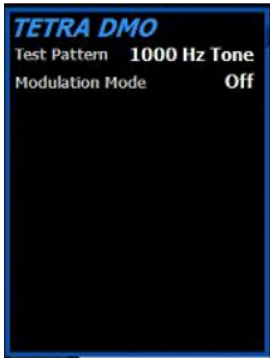

The TETRA DMO Zone offers the following measurement displays:

Residual Carrier Magnitude – Vector offset between the ideal and actual signal. In terms of its constellation, residual carrier would appear as an ideal diagram offset from the origin (0,0). The measurement is performed at optimal symbol times.

EVM (RMS) – Deviation of the actual signal (I/Q vectors) from the ideal signal, as depicted by the red arrow in the image below.

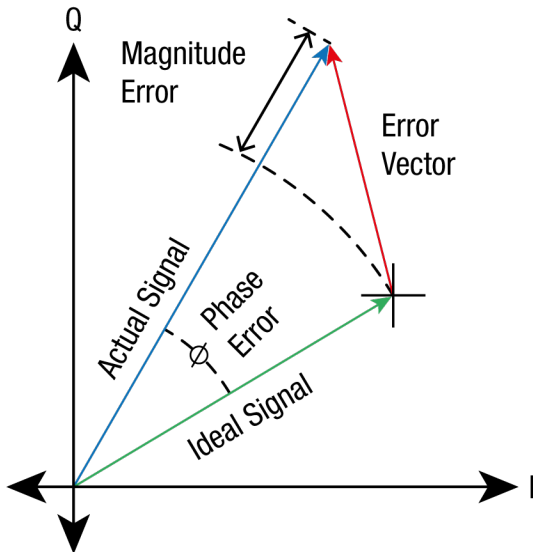

The ideal TETRA DMO signal consists of eight points around the origin. From these, the deviations are measured to all actual points closest to each. In terms of the constellation, it is the distance from the ideal to the actual symbol. The measurement is done at the optimal symbol times and positions to exclude adverse effects of frequency error and residual carrier. The RMS error vector magnitude for a burst is the square root of the sum of the squares of the error distances divided by the number of symbols in the burst.

EVM (Peak) – Maximum error distance found over the burst.

Unwanted Power – Average power in non-active regions of non-active timeslots. Burst transmissions are expected to occur in every slot 1 and at times slot 3. Slots 2 and 4 of all frames are always non-active. The active region of a non-active slot is for ramping of an adjacent active slot. The measurement is done at the optimal symbol times and positions to exclude adverse effects of frequency error and residual carrier.

While the analyzer is operating in TETRA DMO Test Mode, the TETRA DMO Zone soft key menus contain all of the R8200 parameter settings for the controlling the TETRA DMO physical layer. For a complete soft key reference for the TETRA DMO Zone, see **"TETRA DMO Zone Soft Keys" on page 696**.

The DISPLAY Zone

During TETRA DMO Test Mode, the DISPLAY Zone is preconfigured with the Spectrum Analyzer display, but also offers a Power Profile, and Modulation Spectrum/Constellation Display. These are accessed by pressing **Select Display**, as shown in the horizontal soft key menu below.

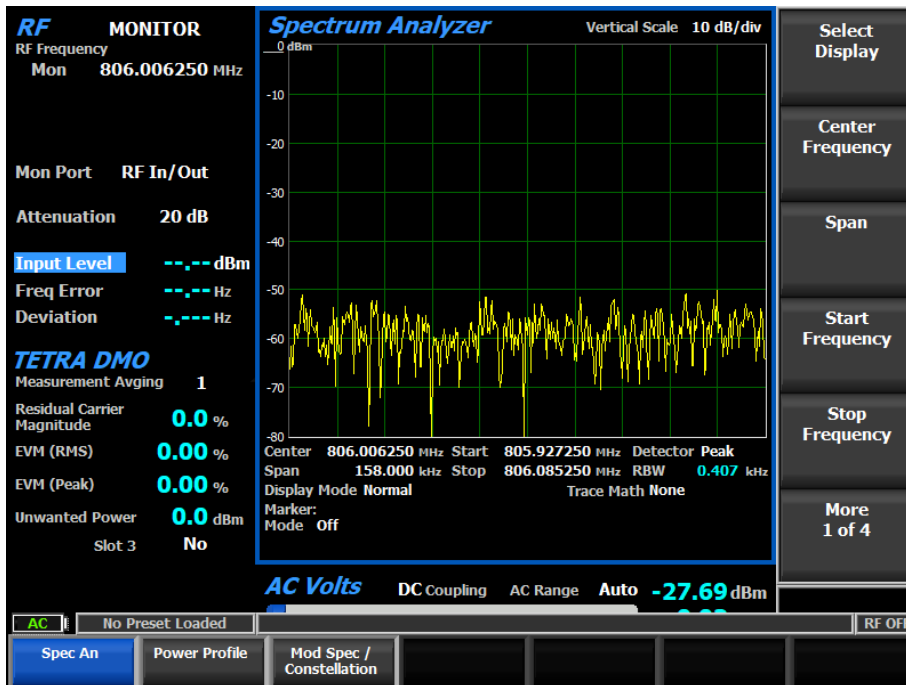

Spectrum Analyzer

See "Introducing the Spectrum Analyzer" on page 93.

Power Profile

See "Power Profile" on page 158.

NOTE

See the Technical Specification: ETSI EN 300 396-2 "Terrestrial Trunked Radio (TETRA); Technical requirements for Direct Mode Operation (DMO); Part 2: Radio aspects," RF output power time mask.

Modulation Spectrum / Constellation Display

The Modulation Spectrum Display is a graph of power versus frequency (power spectral density) of the modulated symbols in the detected burst, shown below.

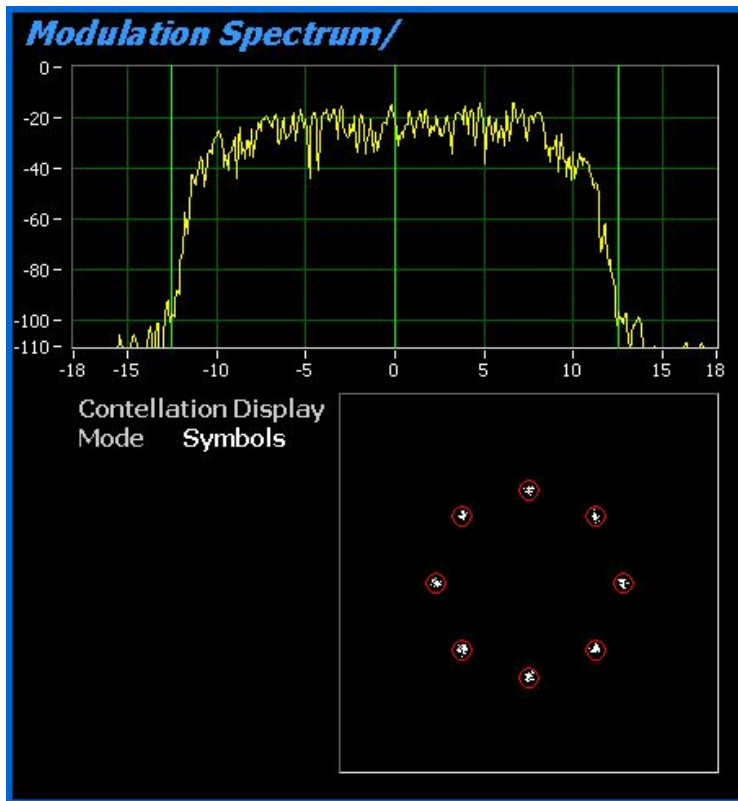

Power is shown in dB relative to Input Level (0 dB); frequency is shown in kHz relative to Center Frequency (0 Hz). The measurement is done by over-sampling at the optimal symbol times and positions to exclude adverse effects of frequency error and residual carrier.

Constellation Display

Displays the EVM measurement and a graph showing the symbol constellation on the complex I/Q plane. The display provides a visual representation of general transmitter performance when the Monitor Modulation Type is complex. TETRA radios broadcast voice and data using four differential phase shift deviations from the carrier to represent symbols containing two data bits. One of four phase shifts relative to the carrier's current phase yields eight phase points. The phase trajectory never passes through the origin, ensuring that signal amplitude never falls to zero during data transmissions. An ideal constellation is shown below.

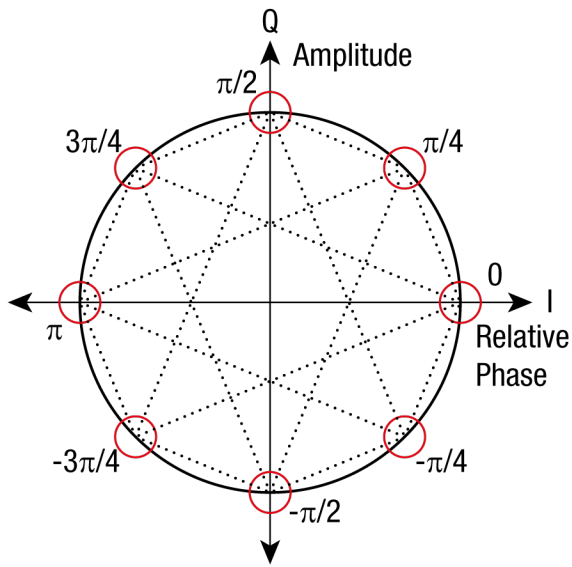

The center of the eight red circles on the display represent the expected locations for the deviation states when the radio is transmitting data bit symbols. White dots show the actual deviation measurement at symbol decision times. A tighter grouping within the red circles indicates more accurate transmitter performance. The radius of the circles is the 10% EVM (Peak) limit, as shown below.

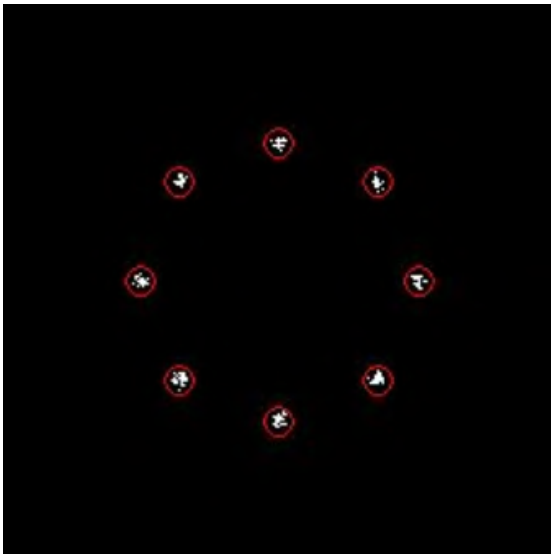

The measurement is executed at the optimal symbol times and positions to exclude the adverse effects of frequency error and residual carrier. The Display Mode setting enables the plotting of symbols (above), samples (left, below), or trajectories (right, below).

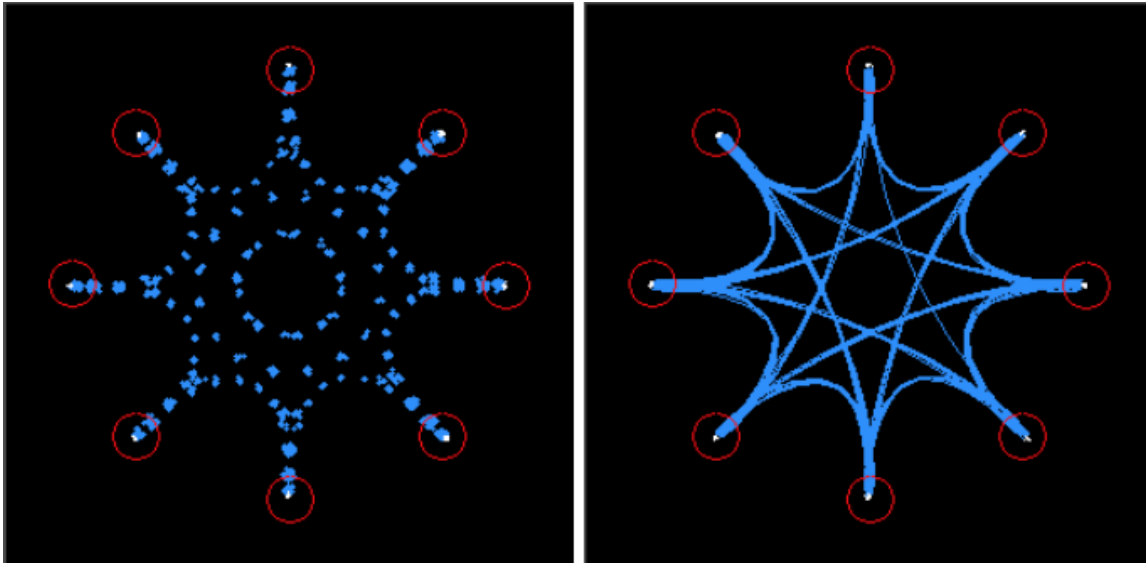

While the analyzer is operating in TETRA DMO Test Mode, the DISPLAY Zone soft key menus contain all of the parameter settings for RF and baseband measurement display. For DISPLAY Zone soft keys unique to TETRA DMO Test Mode, see **"TETRA DMO Zone Soft Keys" on page 696**. For a complete soft key reference for the DISPLAY Zone, see **"DISPLAY Zone Soft Keys for Duplex Mode" on page 496**.

The METER Zone

In TETRA DMO Test Mode, the METER Zone is preloaded with a Voltmeter, as shown.

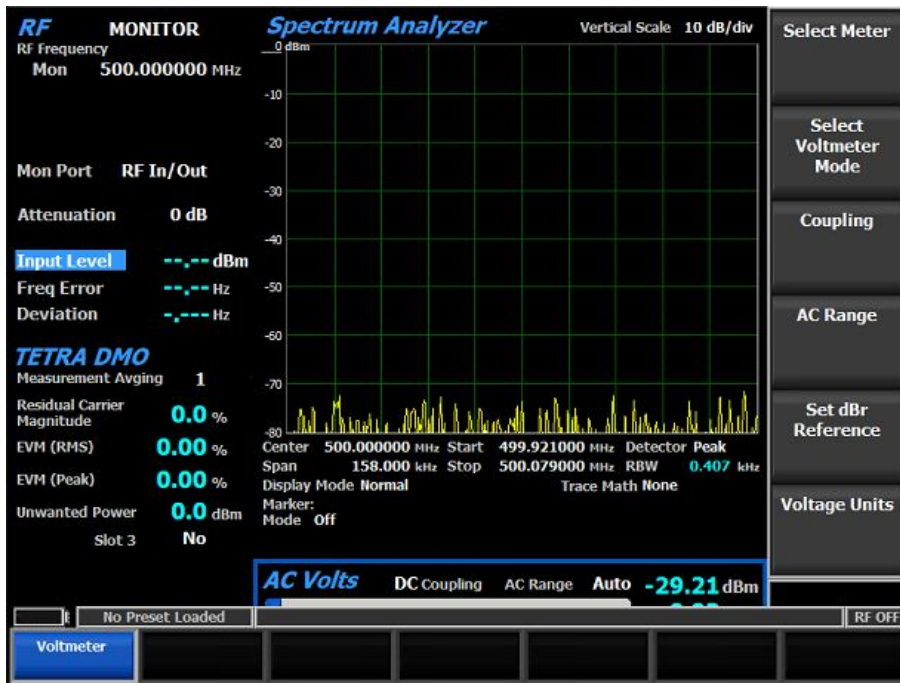

Voltmeter

See ["Voltmeter" on page 101](#).

While the analyzer is operating in TETRA DMO Test Mode, the METER Zone soft key menus contain all of the parameter settings for RF and baseband measurement metering. For METER Zone soft keys unique to TETRA DMO Test Mode, see ["TETRA DMO Zone Soft Keys for Transmitter Test" on page 697](#). For a complete soft key reference for the METER Zone, see ["METER Zone Soft Keys for Monitor Mode" on page 401](#).

To learn about using the R8200 to service portables, mobiles, and system infrastructure employing the TETRA DMO protocol, turn to ["Using TETRA DMO Test Mode" on the next page](#).

Using TETRA DMO Test Mode

This section provides an example measurement using the TETRA DMO Test Mode. Complete this procedure to make an initial verification of a portable radio's digital signal processing without the need for specialized power supplies, test boxes, or radio service software. It can be completed using only the radio, a single BNC cable, and two adapters.

Transceiver Verification

This section describes a simple procedure for verifying the basic functionality of the radio's RF transceiver and physical layer protocol using the R8200 in TETRA DMO Test Mode. Follow these steps to connect the radio to the R8200 and configure your measurement.

Required Equipment

- Freedom R8200 Communications System Analyzer
- Portable Radio, programmed for TETRA DMO (i.e., Motorola, Sepura, Hytera or similar)
- Cable, coax, BNC (m-m)
- Adapter, Type N(f)-to-BNC(f)
- Adapter, SMA(f)-to-BNC(f)

Test Setup

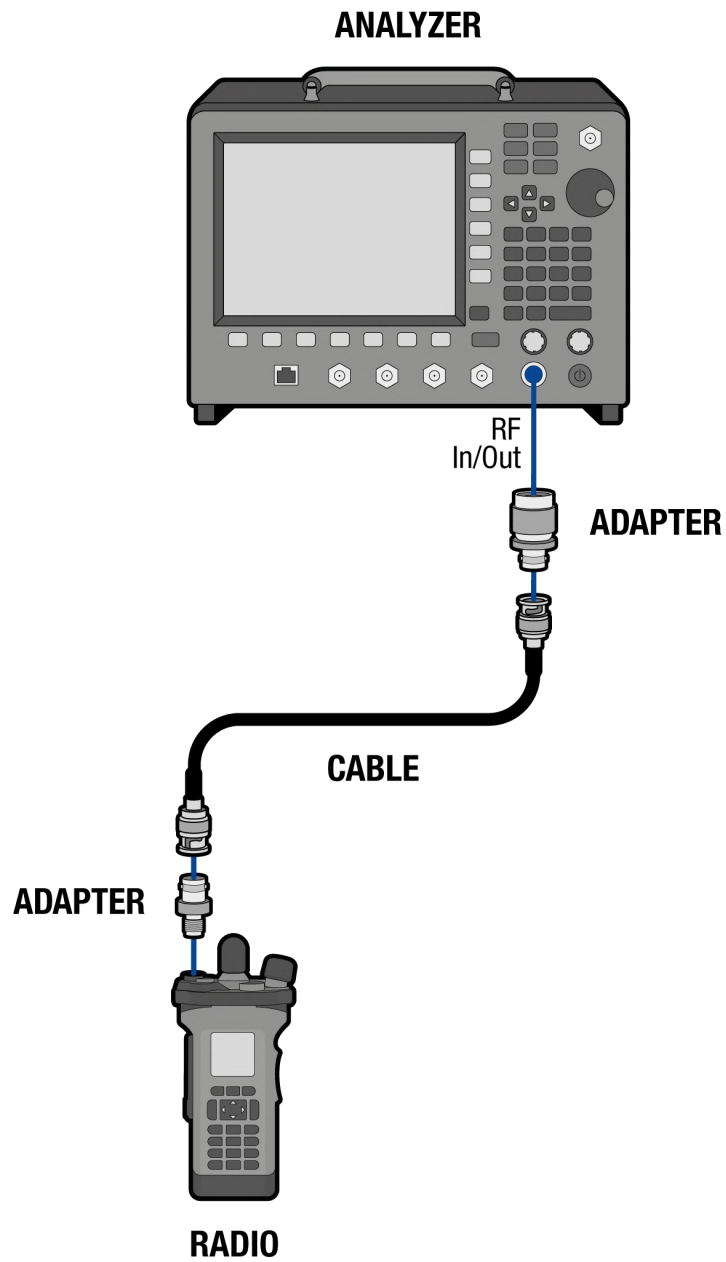

Procedure

Steps	Actions	Notes
1. Configure the test setup.	<ul style="list-style-type: none"> a. Connect the Type N(f)-to-BNC(f) adapter to the R8200 RF In/Out port. b. Remove the antenna from the radio. c. Connect the SMA(f)-to-BNC(f) Adapter to the Antenna port of the radio. d. Connect the BNC cable between the radio and the R8200. 	
2. Configure the R8200.	<ul style="list-style-type: none"> a. Press Test > Test Mode > TETRA DMO. b. To set the receiver Center Frequency to match the radio transmitter, press Hot Key 1 > Monitor Frequency > 863 > MHz. c. In the RF Zone, confirm that Mon Port displays RF In/Out as the receiver input. d. To receive the appropriate TETRA RF power level, disable Auto Attenuation by pressing Settings > System Settings > Automatic Attenuation > Off. e. To set the receiver RF attenuation, press Hot Key 1 > Attenuation > 30 dB > Enter. 	<p>Alternatively, press RF Zone > Monitor Frequency > 863 > MHz.</p> <p>If not, press Mon Port > RF In/Out > Enter.</p>

Steps	Actions	Notes
3. Activate and key the radio.	<ul style="list-style-type: none"> a. Turn the On/Off/Volume Knob clockwise to activate the radio. b. Press PTT on the portable radio. 	This initiates a broadcast of the voice content picked up by the radio microphone.

NOTE

All TETRA Base Station radios can be configured for DMO mode. Normally this configuration is performed when the radio software is programmed. To reach DMO operation a special key press may be needed, or a specific channel selected. Contact your system administrator for details to activate DMO mode.

4. Observe the DISPLAY Zone.	<ul style="list-style-type: none"> a. To verify the radio is producing a TETRA DMO signal, press PTT on the radio. b. Refer to the Spectrum Analyzer display. c. To view the symbol trajectories, press Select Display > Mod Spec / Constellation > Constellation Display Mode > Trajectories. 	<p>You should observe a signal on the Spectrum Analyzer display.</p> <p>You should see active trajectories on display and tight symbols grouped withing the decision circles</p>
5. Observe the RF Zone.	<ul style="list-style-type: none"> a. Confirm that the Input Level displays the radio output as approximately 1.5 W. b. Confirm that the Freq Error displays the radio frequency error as less than 100 Hz. 	This verifies the performance of the radio RF transmitter.
6. Observe the TETRA DMO Zone.	<ul style="list-style-type: none"> a. Press Hot Key 4 > Reset Averaging. b. Press PTT on the radio. c. Confirm that EVM (RMS) displays 5% or less. 	This verifies that the radio is correctly broadcasting the TETRA DMO physical layer signal.

Steps	Actions	Notes
7. Configure the R8200.	<p>a. To configure the TETRA DMO generator on the R8200, press Generate.</p> <p>b. To set the Generate Frequency to match the radio receiver, press Hot Key 1 > Generate Frequency > 863 > MHz.</p> <p>c. To choose a test tone to broadcast to the radio, press Hot Key 4 > Test Pattern > 1000 Hz Tone.</p> <p>d. To broadcast the test tone, press, Modulation Mode > Continuous.</p>	
8. Listen for the 1 kHz tone broadcast from the radio speaker.	a. Adjust the volume of the 1000 Hz tone using the radio On/Off/Volume Knob.	This verifies that the radio correctly decodes the TETRA DMO baseband content.
9. Test the sensitivity of the radio.	<p>a. To adjust the Output Level of the R8200, press Hot Key 1 > Output Level.</p> <p>b. Use the arrow keys and the tuning knob to decrease the Output Level until the 1000 Hz tone is no longer broadcast from the radio speaker.</p> <p>c. Confirm that the RF Output Level on the R8200 is <i>less than -112 dBm</i> when the tone disappears.</p>	This confirms that the radio receiver is sensitive to transmissions as weak as -112 dBm.

Having confirmed these parameters, you can verify that the transceiver on this radio is working properly in TETRA DMO Mode.

Introducing TETRA TMO Test Mode

The optional R8200 TETRA TMO Test Package option enables testing of radios compliant with the ETSI Terrestrial Trunked Radio (TETRA) Direct Mode Operation (DMO) radio transmission protocol per ETSI specification EN 300 396-2 Terrestrial Trunked Radio (TETRA); Technical requirements for Direct Mode Operation (DMO); Part 2: Radio aspects. TETRA radios use a digital transmission format employing $\pi/4$ DQPSK modulation at 36000 four-bit symbols per second with Time Division Multiple Access (TDMA) with four slots per frame as its channel access methodology.

TETRA TMO Test Mode provides performance verification functionality compliant with ETSI specification EN 300 396. The manufacturer's Radio Service Software (RSS) is required to perform T1 tests in TETRA TMO Mode. These receiver and transmitter performance verification measurements include Receiver Sensitivity, Slot Power, Frequency Error, Residual Carrier Magnitude, EVM (RMS and Peak), Unwanted Power, Frame Alignment Symbols, and PLC test. In addition, the TETRA TMO Test Mode comes equipped with a Spectrum Analyzer, Power Profile, and Modulation Spectrum/Constellation Displays.

Pressing **Test > Test Mode > TETRA TMO > TETRA TMO** configures the R8200 for TETRA TMO Test Mode.

TETRA TMO Verification Tests

The application was designed for maximum flexibility across a variety of TETRA TMO hardware implementations. Unlike the classic Four-Zone R8000-Series display user interface, TETRA TMO Test Mode channel assignment and baseband configuration is provided by an off-screen Channel Plan Table so that the Main Screen can be focused on displaying as many system critical measurements as possible, as shown.

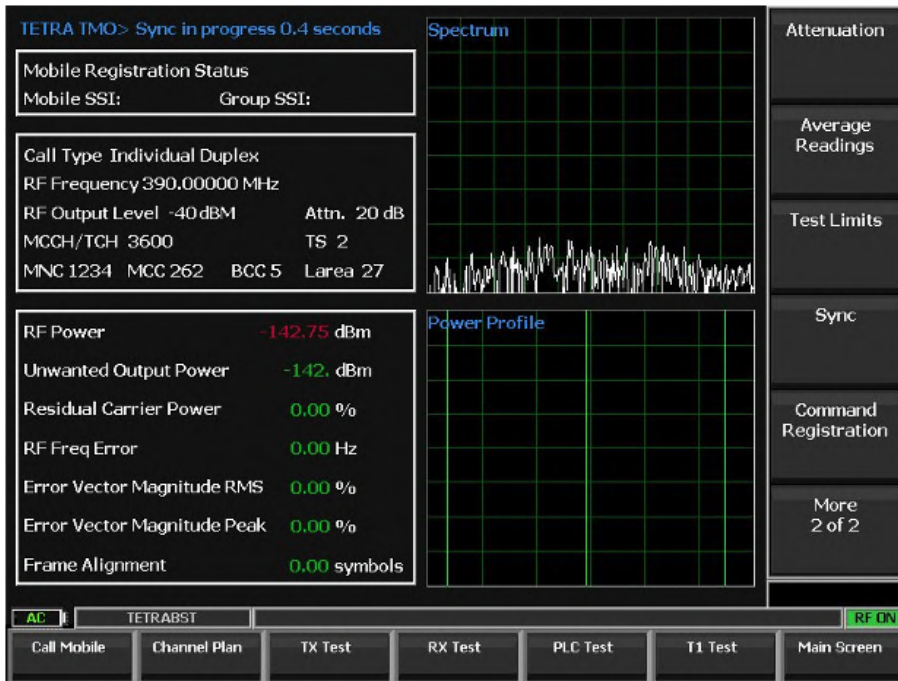

In TETRA TMO Test Mode, the R8200 emulates a trunking Base Station. It provides a Main Screen that offers call configuration and 5 performance verification test modes: Monitor Mode, Transmitter (TX) Test, Receiver (RX) Test, Power Loop Control (PLC) Test, and T1 Test. The following sections describe the Main Display and each Test Mode display in detail.

Monitor Mode in Main Screen

In the TETRA TMO Main Screen, the R8200 emulates a trunking TMO Network Base Station which enables the call configuration and performance verification of subscriber radios.

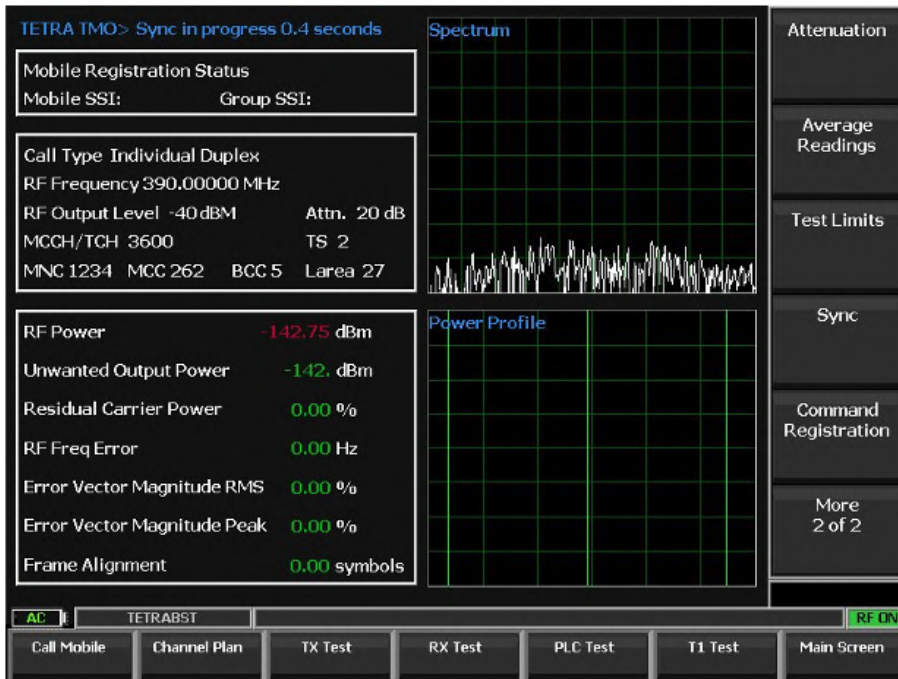

The Main Screen features a TETRA Configuration Display above a Measurements Display on the left side of the screen and Mini Graphical Displays on the right side, as shown above.

TETRA Configuration Display

This area (shown above) presents the following RF and TETRA parameter settings for the receiver:

Mobile SSI – Displays the current Individual Short Subscriber Identity of the radio under test.

Group SSI – Displays the current Group Short Subscriber Identity of the radio under test.

Call Type – Displays one of the seven Call Types for the radio under test.

RF Frequency – Displays the Monitor Frequency for the receiver.

RF Output Level – Displays the RF output level of the Uplink signal transmitted by the R8200.

MCCH/TCH – Displays the Main Control (MCCH) and Traffic (TCH) channel number.

MNC – Displays the TMO Mobile Network Code.

MCC – Displays the TMO Mobile Country Code.

BCC– Displays the TMO Colour Code.

LA – Displays the Larea Code.

TS - Displays the active timeslot.

Attn – Displays the amount of attenuation on the receiver port.

Measurements Display

This area (shown above, beneath the TETRA Configuration Display) presents the following RF parameters and measurements:

RF Power – Displays the burst power level of the synchronized TDMA slot 1 transmitted by the radio under test. The measurement is done at the optimal symbol times and positions to exclude adverse effects of frequency error and residual carrier. Averaging over multiple bursts may be performed to comply with the standard. Between 1 and 250 RF power samples are collected five to 17 times per second. The number of Averaging samples can be configured by pressing the **Averaging Readings** soft key. The current number of samples is displayed as Averaging at the top of the Measurements Display. The **Reset Averaging** soft key can be pressed to zero all TETRA TMO measurements, history, and displays, including ones in other zones.

Residual Carrier Power – Displays the percentage of carrier power from inactive timeslots.

RF Freq Error – Displays the frequency difference between the received Downlink Frequency and the R8200 current Monitor Frequency setting.

Error Vector Magnitude RMS – Displays the average deviation of the actual I/Q vectors from the ideal vectors as a percentage beyond the ideal (0% Error Vector Magnitude), as depicted by the red arrow in the image below.

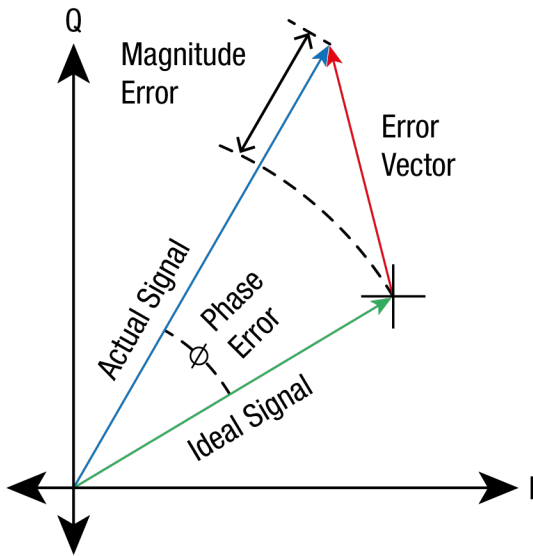

The ideal TETRA TMO signal consists of eight decision points around the origin. From these, the deviations are measured to all actual decision points closest to each. In terms of the constellation, it is the distance from the ideal to the actual symbol. The measurement is done at the optimal symbol times and positions to exclude adverse effects of frequency error and residual carrier. The RMS error vector magnitude for a burst is the square root of the sum of the squares of the error distances divided by the number of symbols in the burst.

Error Vector Magnitude Peak – Displays the maximum error distance found over the burst as a percentage beyond the ideal (0% Peak Error Vector Magnitude).

Frame Alignment – Displays the deviation from the number of expected symbols in a TETRA frame.

Mini Graphical Displays

This area (shown above, on the right side of the display screen) presents a dual display of the following graphical RF measurements:

Spectrum – Displays a power-versus-frequency representation of the base station transmitted carrier signal.

Power Profile – Display provides a power versus time plot of the transmitted timeslots. This specialized Oscilloscope display is useful for ensuring that near-far situations will not result in co-channel inter-slot interference on the alternate or non-transmission slot and that the power level will be adequate for acceptable BER performance. The scaling and position of the vertical power axis can be adjusted to inspect greater range or detail. The horizontal axis can be changed to view one or both slots including the additional ramp up/down time.

Symbols – Displays the measured symbol decision points as white dots and plots them on a Constellation Display of the ideal target decision points. The red targets represent the area within the 10% EVM test limit.

Trajectories – Displays the trajectories of the symbols between decision points as blue traces on a Constellation Display of the ideal target decision points.

Bar Graphs – Displays bar graphs of the measurements represented numerically in the Measurements Display area to the right.

Graphical Displays

Full screen versions of the following instrument displays can be accessed by pressing **Graphical Displays**:

Bar Charts

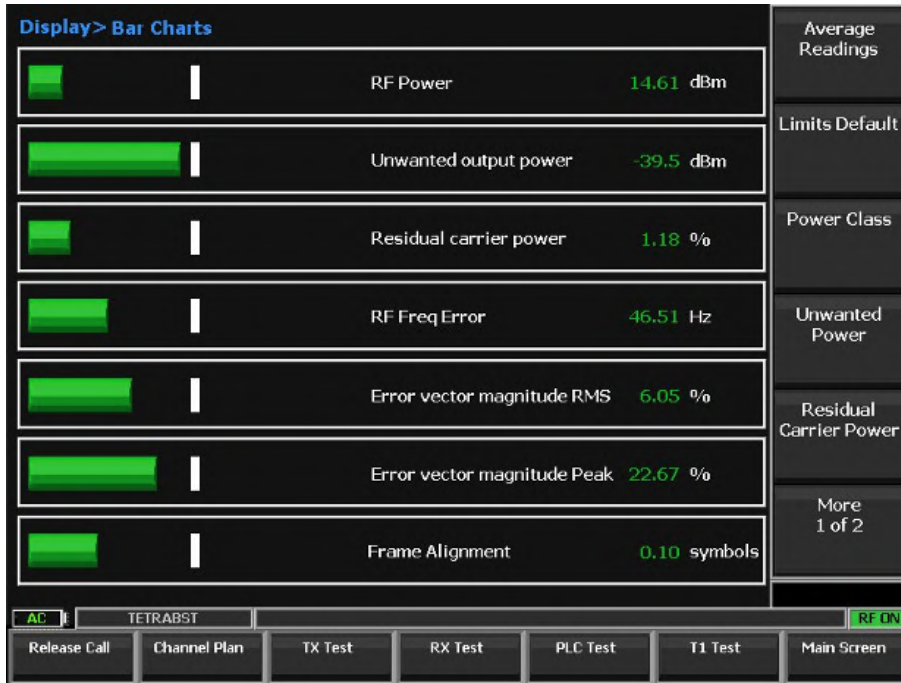

The full screen Bar Charts Display include soft keys for configuring the Test Limits of the measurements represented in the Bar Charts Display.

Spectrum Analyzer

See ["Introducing the Spectrum Analyzer" on page 93](#).

Power Profile

See ["Power Profile" on page 158](#) for additional details.

NOTE

See the Technical Specification: ETSI EN 300 396-2 "Terrestrial Trunked Radio (TETRA); Technical requirements for Direct Mode Operation (DMO); Part 2: Radio aspects," RF output power time mask.

Constellation

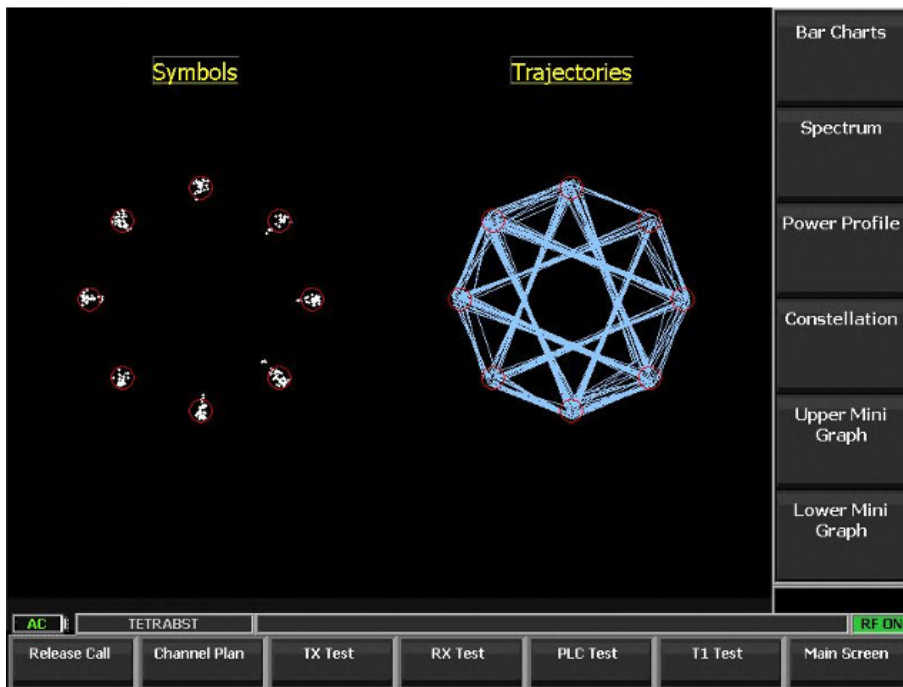

Symbols (above left) displays the measured symbol decision points as white dots and plots them on a Constellation Display of the ideal target decision points. The red targets represent the area within the 10% EVM test limit. Trajectories (above right) displays the signal path as a blue trace as it passes between decision points on a Constellation Display of the ideal targets.

Test Limits

TETRA TMO> Test Limits			RMS Vector
Test Limits	Lower	Upper	Peak Vector
RF Power Level	28 dB	32 dB	Frame Align Symbols
Unwanted Power		-36 dB	RX Sensitivity
Residual Carrier Power	0 %	5 %	MS T1 BER
Frequency Error	-100 Hz	100 Hz	More 2 of 3
RMS Vector Error	0 %	10 %	
Peak Vector Error	0 %	30 %	
Frame Alignment Symbols	-0.250 sym	0.250 sym	
RX Sensitivity	-114 dBm		
MS T1 BER		3.000 %	
MS T1 MER		3.000 %	

AC	TETRA	TETRA	TETRA	TETRA	TETRA	TETRA	RF ON
Call Mobile	Channel Plan	TX Test	RX Test	PLC Test	T1 Test	Main Screen	

Pressing **Test Limits** opens the Test Limits Table (above) where you can use the vertical soft key menu to automatically configure the PASS/FAIL boundaries for every measurement in the Measurements Display. These limits are mirrored in the Bar Charts display. Pressing **Limits Default** returns all limit settings to the ETSI standard values.

Channel Plan Table

The Channel Plan Table displays the current TETRA TMO subscriber unit configuration, as shown.

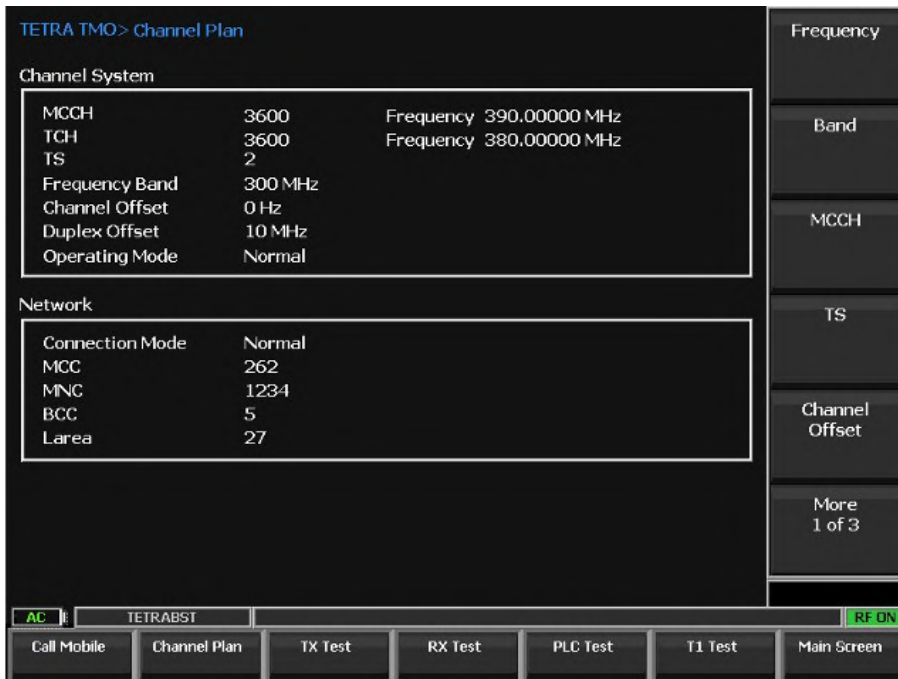

Use the soft keys in the Main Menu vertical soft key menu to configure the RF parameters and the TETRA channeling codes.

NOTE

Failure to set these parameters correctly will result in invalid test results for TX and RX BER.

Channel System

MCCH – Displays the Main Control Channel number and associated transmitter frequency.

TCH – Displays the Main Control Channel number and associated transmitter frequency.

TS - Displays the active timeslot.

Frequency Band – Displays the specified harmonized Frequency Band transmitted by the R8200.

Channel Offset – Displays the current Downlink Channel Offset frequency.

Duplex Offset – Displays the current Offset Frequency for both Uplink and Downlink Channels.

Operating Mode – Displays the current forward or reverse mode of operation.

Network

Connection Mode – Displays the Normal or Fallback Connection Mode.

MCC – Displays the TMO Mobile Country Code.

MNC – Displays the TMO Mobile Network Code.

BCC– Displays the TMO Colour Code.

Larea – Displays the Local Area Code.

TX Test

The screenshot shows the 'TETRA TMO > TX Test' interface. It includes a 'TX Setup' section with a text field for 'No. of Bursts for Average Calculation' set to 50. Below is a 'TX Results' table with columns for 'Current', 'Min', 'Max', and 'Average'. The table contains data for RF Power dBm, Unwanted Power dBm, Frequency Error Hz, RMS Vector Error %, Peak Vector Error %, Residual Carrier Power %, and Frame Alignment Symbols. A 'TX Status' section shows 'Burst Samples Counter' set to 50. On the right, a vertical soft key menu has options for 'Burst Samples', 'Start Test', and 'Test Results'. At the bottom, there is a status bar with 'AC: TETRABST' and 'RF ON', and a navigation bar with buttons for 'Call Mobile', 'Channel Plan', 'TX Test', 'RX Test', 'PLC Test', 'T1 Test', and 'Main Screen'.

	Current	Min	Max	Average
RF Power dBm	14.575	14.485	14.661	14.585
Unwanted Power dBm	-40.561	-40.885	-40.418	-40.633
Frequency Error Hz	27.167	26.602	29.72	27.53
RMS Vector Error %	5.982	5.378	6.954	6.04
Peak Vector Error %	21.658	17.148	25.16	21.445
Residual Carrier Power %	1.786	0.085	2.555	1.136
Frame Alignment Symbols	0.133	0.062	0.148	0.122

Pressing **TX Test** opens the TX Test Table (above) where you can use the vertical soft key menu to configure your OTA performance verification of a subscriber radio. The Burst Samples setting determines the length of the test as well as the number of burst samples from which to calculate the results populating the Average column. The

remaining soft keys execute the OTA transmitter test and to display the results, shown below. The transmitter test terminates when the prescribed number of samples has been gathered. See **"Measurements Display" on page 261** for an explanation of individual results.

TETRA TMO> Test Results

Radio Test Results

Network	262/1234			
	Last	Min	Max	Average
TX Test:				
RF Power	14.5752	14.4848	14.6612	14.5855 (PASS)
Unwanted Output Power	-40.5612	-40.8854	-40.4176	40.6331 (PASS)
Residual Carrier Power	1.7862	0.0852	2.5551	1.1356 (PASS)
RF Frequency Error	27.1673	26.6018	29.7196	27.5304 (PASS)
Error Vector Magnitude RMS	5.9824	5.3781	6.9536	6.0398 (PASS)
Error Vector Magnitude Peak	21.6582	17.1477	25.1596	21.4451 (PASS)
Frame Alignment	0.1328	0.0625	0.1484	0.1223 (PASS)
RX Test:				
RX Sensitivity	-122 dBm (PASS)			
PLC Test:				
Power Level 1	14.549 dBm (PASS)			
Power Level 2	20.056 dBm (PASS)			
Power Level 3	24.920 dBm (PASS)			
Power Level 4	29.762 dBm (PASS)			
Power Level 5	32.080 dBm (PASS)			
Power Level 6				

Operator ID

Mobile ID

Export to CSV

Export Log Files

Clear Results

AC

TETRABST

RF ON

Call Mobile

Channel Plan

TX Test

RX Test

PLC Test

T1 Test

Main Screen

RX Test



Pressing **RX Test** opens the RX Test Table (above) where you can use the vertical soft key menu to configure your RX Sensitivity performance verification of a subscriber radio. The Start Level setting determines the power of the initial transmission for the test. The Step Level is the number of decibels that the Power Level is reduced with each step of the test. Start RX Test begins the procedure. Results can be viewed by pressing Test Results.

PLC Test

TETRA TMO>Power Loop Control Test

Power Class 3L (1.8W)

Power Level 1 = 15 dBm ±2 dBm	14.549 dBm
Power Level 2 = 20 dBm ±2 dBm	20.056 dBm
Power Level 3 = 25 dBm ±2 dBm	24.92 dBm
Power Level 4 = 30 dBm ±2 dBm	29.762 dBm
Power Level 5 = 32.5 dBm ±2 dBm	32.08 dBm

Start PLC Test

Test Results

AC TETRABST RF ON

Call Mobile Channel Plan TX Test RX Test PLC Test T1 Test Main Screen

Pressing **PLC Test** opens the PLC Test Table (above) where you can use the vertical soft key menu to perform a Power Loop Control Test on a subscriber radio. Start PLC Test begins the procedure. Results can be viewed by pressing Test Results.

T1 Test



TETRA TMO T1 Test contains additional parameter controls for the TETRA TMO T1 Test Table for transceiver performance verification of the subscriber unit under test using the manufacturer Test Mode Software. T1 Test Mode will provide the correct Uplink response to the Downlink T1 and Network settings. T1 Test Mode provides 3 different Burst Types, 3 different mobile subscriber modes, and user-defined RF output power in order to complete T1 Bit Error Rate and Modulation Error Rate performance verification for the subscriber unit under test.

While the analyzer is operating in TETRA TMO Test Monitor Mode, its soft key menus contain all of the R8200 parameter settings for configuring, performing, and recording the results of OTA TMO performance verification tests. For a complete soft key reference, see **"TETRA TMO Test Mode Soft Keys" on page 708**.

Using TETRA TMO Test Mode

This section provides an example measurement using the TETRA TMO Test Mode. Complete this procedure to make an initial verification of a portable radio's digital signal processing without the need for specialized power supplies, test boxes, or radio service software. It can be completed using only the radio, a single BNC cable, and two adapters.

Transceiver Verification

This section describes a simple procedure for verifying the basic functionality of the radio's RF transceiver and physical layer protocol using the R8200 in TETRA TMO Test Mode. Follow these steps to connect the radio to the R8200 and configure your measurement.

Required Equipment

- Freedom R8200 Communications System Analyzer
- Portable Radio, programmed for TETRA TMO (i.e., Motorola, Sepura, Hytera or similar)
- Cable, coax, BNC (m-m)
- Adapter, Type N(f)-to-BNC(f)
- Adapter, SMA(f)-to-BNC(f)

Test Setup

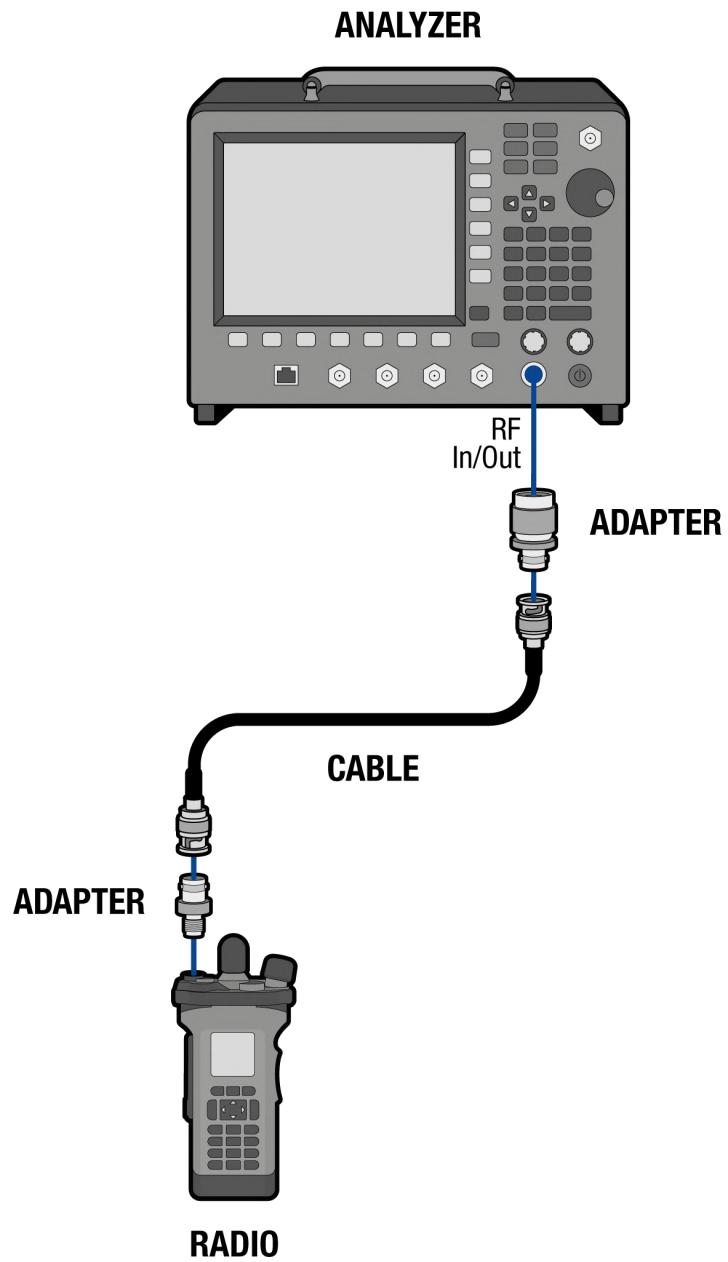

Procedure

Steps	Actions	Notes
1. Configure the test setup.	<ul style="list-style-type: none"> a. Connect the Type N(f)-to-BNC(f) adapter to the R8200 RF In/Out port. b. Remove the antenna from the radio. c. Connect the SMA(f)-to-BNC(f) Adapter to the Antenna port of the radio. d. Connect the BNC cable between the radio and the R8200. 	
2. Gather the TETRA TMO network programming information for the radio under test (it may be necessary to refer to the manufacturer Radio Support Software).	<ul style="list-style-type: none"> a. Record the MCCH/TCH. b. Record the MNC. c. Record the MCC. d. Record the BCC. e. Record the TS. f. Record the Larea. 	<p>This example uses the following network programming parameters:</p> <p>MCCH/TCH = 3600 MNC = 1234 MCC = 262 BCC = 5 TS = 2 Larea = 27</p>
3. Configure the R8200.	<ul style="list-style-type: none"> a. Press Test > Test Mode > TETRA TMO > TETRA TMO. b. To configure the network programming for the subscriber unit, press Channel Plan. c. Press the following soft keys to enter your radio's network configuration parameters: MCCH, TS, Channel Offset, Duplex Offset, Operating Mode, Con- 	<p>This will open the Main Screen display for TETRA TMO Test Mode.</p>

Steps	Actions	Notes
	nection Mode, MCC, MNC, BCC, and Larea.	
4. Activate the radio.	a. Turn the On/Off/Volume Knob clockwise to activate the radio.	The radio will scan for a valid network and then perform a registration with the R8200, then beep and display its connected status.
5. Configure the R8200.	<p>a. To show the Bar Graphs in the Mini Display, press Graphical Displays > Lower Mini Graph > Bar Graphs.</p> <p>b. To address the radio, in the horizontal soft key menu, press Call Mobile.</p> <p>c. When the radio rings, answer the call.</p>	
6. Observe the DISPLAY Zone.	<p>a. To verify the radio is producing a valid TETRA TMO signal, refer to the Bar Graph display.</p> <p>b. Refer to the Spectrum Analyzer display.</p> <p>c. To view symbols and trajectories, press Select Display > Constellation.</p>	<p>You should observe green bars in the Bar Graphs if the radio is working properly.</p> <p>You should observe a TMO signal in the Spectrum Analyzer display if the radio is working properly.</p> <p>You should observe active trajectories on display and tight symbols grouped withing the decision circles.</p>
7. Release the call.	a. To release the call, in the horizontal soft key menu, press Release Call.	This verifies the performance of the radio's RF transceiver.
8. Perform a Transmitter Verification test.	<p>a. To perform a receiver sensitivity test, press TX Test > Start TX Test.</p> <p>b. To view results, press Test Res-</p>	This verifies the performance of the radio's RF transmitter.

Steps	Actions	Notes
9. Perform a Receiver Sensitivity test.	<p data-bbox="654 268 703 298">ults.</p> <p data-bbox="613 310 987 422">a. To perform a receiver sensitivity test, press RX Test > Start RX Test.</p> <p data-bbox="613 453 987 520">b. To view results, press Test Results.</p>	This verifies the performance of the radio's RF receiver.
10. Perform a Power Loop Control test.	<p data-bbox="613 537 987 648">a. To perform a receiver sensitivity test, press PLC Test > Start PLCTest.</p> <p data-bbox="613 680 987 749">b. To view results, press Test Results.</p>	This verifies the performance of the radio's RF receiver.

Having confirmed these parameters, you can verify that the transceiver on this radio is working properly in TETRA TMO Mode.

Introducing dPMR Test Mode

The R8200 dPMR Test Package option dPMR Test Mode allows testing of radios compliant with the Digital Private Mobile Radio (dPMR) protocol. dPMR radios use a digital transmission format employing Four-Level Frequency Shift Keying (4FSK) modulation in an RF spectrum managed by Frequency Division Multiple Access (FDMA) technology. The R8200 dPMR Test Mode provides performance verification functions compliant with the Conformance Test section of the dPMR Common Air Interface (CAI) standard. These include RF Power, Frequency Error and Deviation, Symbol Deviation, Modulation Fidelity (FSK Error), and Bit Error Rate (BER). BER tests require the manufacturer's Radio Service Software (RSS) to place the radio in a special test mode. The dPMR format also provides Test Patterns for BER verification. In addition, a Spectrum Analyzer, Modulation Scope, Oscilloscope, Bar Graphs, and an Eye Diagram with graphical representation of the dPMR signal are provided. A Voice Loopback function enables the Voice Loop feature (U.S. patent 5703479) for audio verification of the radio's end-to-end operation. Both provide qualitative indication of the radio's performance. Averaging can be applied to some measurements via the System Settings.

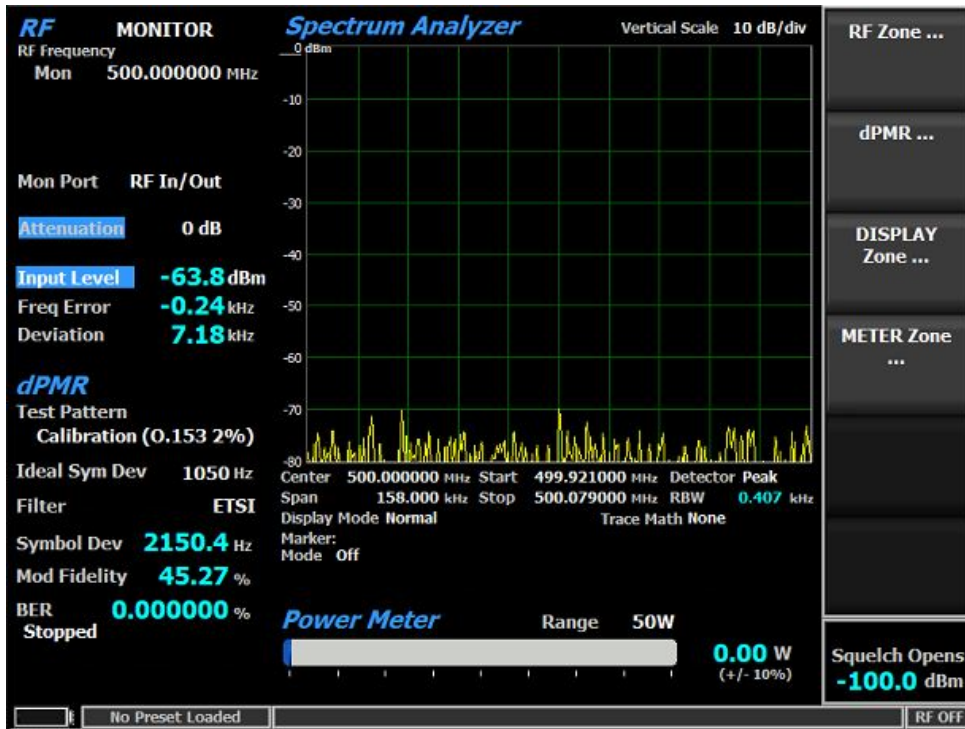

Pressing **Test > Test Mode > dPMR** configures the R8200 for dPMR protocol testing, as shown above. On the R8200 main display, the Standard mode's AUDIO Zone and associated soft keys are replaced by the dPMR Zone and dPMR-specific soft keys (accessed by pressing the **dPMR** soft key).

The RF Zone

In dPMR Test Mode, the RF Zone displays parameters associated with the dPMR carrier stimulus generated by the R8200 as well as measurements of the RF transmissions received from the radio under test. The RF Zone during dPMR transmitter testing (with the R8200 in Monitor Mode) is shown on the left while the RF Zone during dPMR receiver testing (with the R8200 in Generate Mode) is shown below.

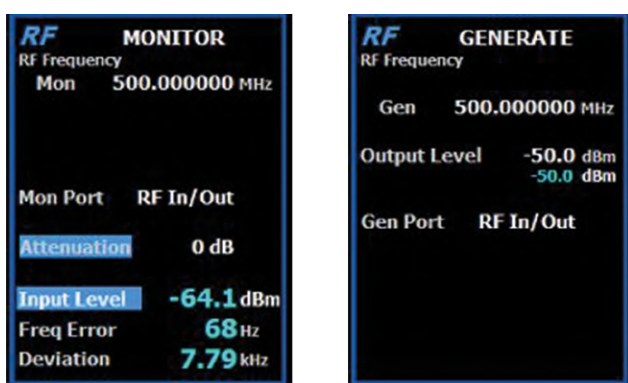

During dPMR Test Mode, the RF Zone offers the following measurement displays:

Input Level – Displays the average power in the dPMR channel under test.

Freq Error – Displays the frequency difference of the received dPMR transmission carrier minus the R8200 Monitor Frequency.

Deviation – Displays the positive peak FM frequency deviation of the received modulated carrier (i.e. from the Frequency Error mean). See negative peak frequency deviation with DISPLAY Zone Bar Graphs.

NOTE

When the RF input power on the RF In/Out port is above +20 dBm (100 mW), the R8200 utilizes a broadband power detector for the measurement. The Input Level field in the RF Zone changes to Watt Meter to indicate this measurement mode. For best accuracy, disable the Pre-amplifier in Monitor Mode and set the Gen Port in Generate Mode to RF In/Out.

While the analyzer is operating in dPMR Test Mode, the RF Zone soft key menus contain all of the parameter settings for the controlling the R8200 RF output. For a complete soft key reference for the RF Zone, see ["RF Zone Soft Keys for Duplex Mode" on page 462](#).

The dPMR Zone

While operating in dPMR Test Mode, the AUDIO Zone and AUDIO Zone soft keys are replaced by the dPMR Zone and dPMR specific soft keys. The dPMR Zone displays the physical layer parameters that can be configured to encode and decode dPMR content. The dPMR Zone is shown in Monitor Mode on the left, Generate Mode on the right, below.



The dPMR Zone offers the following measurement displays:

Symbol Dev – Displays the symbol deviation estimated by averaging the normalized frequency deviations at symbol times in the specified burst of the synchronized FDMA slot of the received signal and then scaling by the maximum symbol value. The normalized frequency deviation is computed as the ratio of the actual frequency measurement at a given symbol or deviation state by the corresponding symbol value. dPMR radios broadcast voice and data using a four level frequency deviation of the carrier to represent symbols containing data bits as shown in the table below. The nominal symbol deviation value for a dPMR radio using 4FSK modulation is 1050 Hz in a 6.25 kHz channel. Since the deviation of a dPMR 4FSK signal is data dependent, that aspect is factored when measuring overall carrier deviation. The Symbol Deviation field provides the deviation measurement at symbol decision times.

Bits	Symbol	Frequency Deviation
01	+3	+1050 Hz
00	+1	+350 Hz
10	-1	-350 Hz
11	-3	-1050 Hz

Mod Fidelity – Modulation Fidelity (FSK error) represents how accurate a transmitter reproduces an ideal theoretical modulation waveform. The measurement is performed by first removing frequency error and symbol deviation gain error from the received signal, then computing the RMS difference between the deviation of the resulting signal at each symbol decision point and the ideal deviations of those symbols; no bit errors should exist. On the R8200, this is reported as an RMS error in % relative to the mean deviation across symbols.

BER – Displays the percentage of bit differences between the bits of the selected Test Pattern and the bits from the received synchronized FDMA signal. This bit error rate test checks the modulation, encoding, and timing of the transmit signal during the data transmission period. When performing the BER Test, the radio transmitter under test must be placed into a test diagnostic mode with the correct TX test pattern selected using the manufacturer's Radio Service Software (RSS). The test is done at nominal power with the radio transmitting the test pattern into the service monitor. (It is acceptable to have an attenuator between the radio under test and the service monitor.)

While the analyzer is operating in dPMR Test Mode, the dPMR Zone soft key menus contain all of the R8200 parameter settings for controlling the dPMR physical layer. For a complete soft key reference for the dPMR Zone, see ["dPMR Zone Soft Keys" on page 730](#).

The DISPLAY Zone

During dPMR Test Mode, the DISPLAY Zone offers a Spectrum Analyzer, Modulation Scope, Oscilloscope, Bar Graphs, and an Eye Diagram, accessed by pressing **Select Display**, as shown in the horizontal soft key menu below.

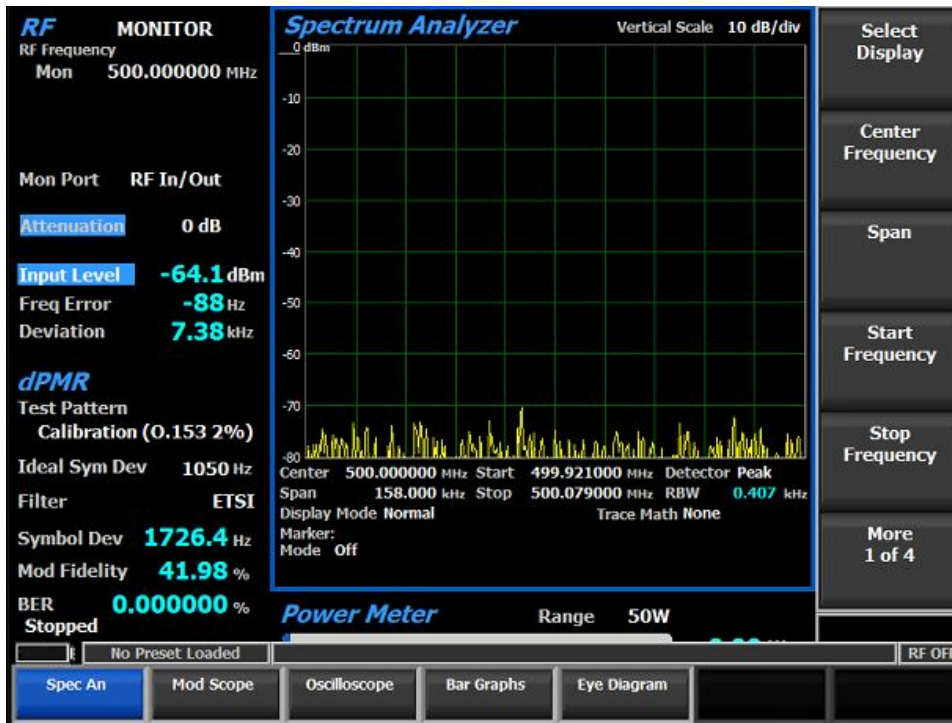

Spectrum Analyzer

See "Introducing the Spectrum Analyzer" on page 93.

Modulation Scope

See "Introducing the Modulation Scope" on page 95.

Oscilloscope

See "Introducing the Oscilloscope" on page 96.

Bar Graphs

See "Bar Graphs" on page 80.

Eye Diagram

See "Eye Diagram" on page 157.

While the analyzer is operating in dPMR Test Mode, the DISPLAY Zone soft key menus contain all of the parameter settings for RF and baseband measurement display. For DISPLAY Zone soft keys unique to dPMR Test Mode, see **"DISPLAY Zone Soft Keys for dPMR Transmitter Test" on page 734**. For a complete soft key reference for the DISPLAY Zone, see **"DISPLAY Zone Soft Keys for Duplex Mode" on page 496**.

The METER Zone

In dPMR Test Mode, the METER Zone is preloaded with a Power Meter.

A Voltmeter and RF Scan are also available by pressing **Hot Key 5 > Select Meter** and choosing the desired meter, as shown below.

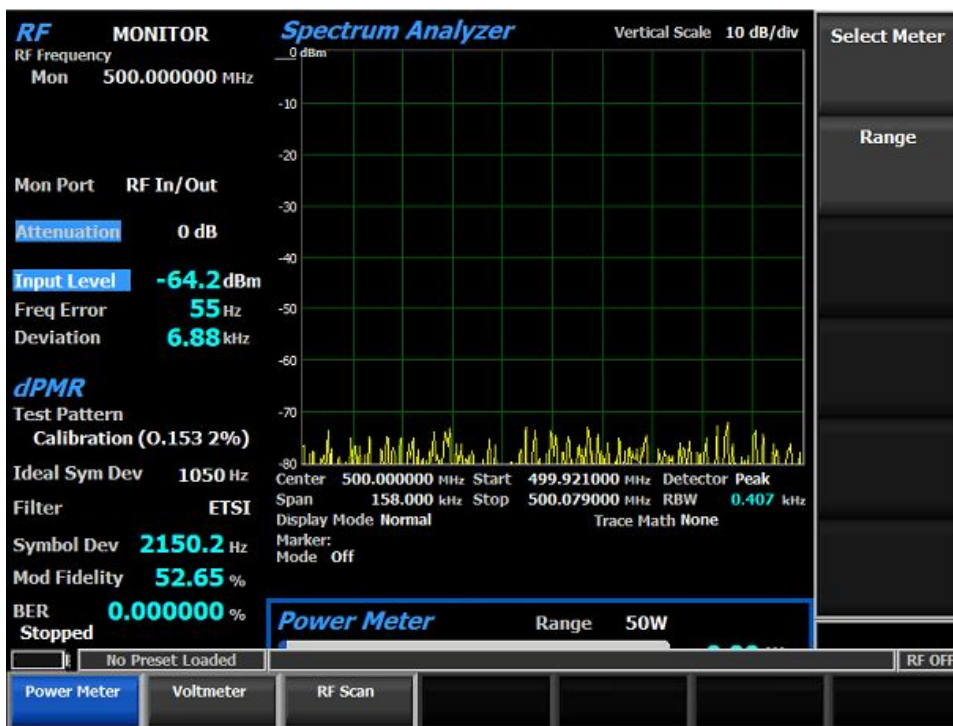

Power Meter

See **"Power Meter" on page 100**.

Voltmeter

See ["Voltmeter" on page 101](#).

RF Scan

["RF Scan" on page 106](#).

While the analyzer is operating in dPMR Test Mode, the METER Zone soft key menus contain all of the parameter settings for RF and baseband measurement metering. For METER Zone soft keys unique to dPMR Test Mode, see ["METER Zone Soft Keys for dPMR Transmitter Test" on page 736](#). For a complete soft key reference for the METER Zone, see ["METER Zone Soft Keys for Monitor Mode" on page 401](#).

To learn about using the R8200 to service portables, mobiles, and system infrastructure employing the dPMR protocol, turn to ["Using dPMR Test Mode" on the next page](#).

Using dPMR Test Mode

This section provides an example measurement using the analyzer's dPMR Mode. Complete this procedure to make an initial verification measurement of a portable radio's digital signal processing without the need for specialized power supplies, test boxes, or radio service software. It can be completed using only the radio, a single BNC cable, and two adapters.

Transceiver Verification

This section describes a simple procedure for verifying the basic functionality of the radio's RF transceiver and physical layer protocol using the R8200 in dPMR Mode. Follow these steps to connect the radio to the R8200 and configure your measurement.

Required Equipment

- Freedom R8200 Communications System Analyzer
- Portable Radio, programmed for dPMR direct mode
- Cable, coax, BNC (m-m)
- Adapter, Type N(f)-to-BNC(f)
- Adapter, SMA(f)-to-BNC(f)

Test Setup

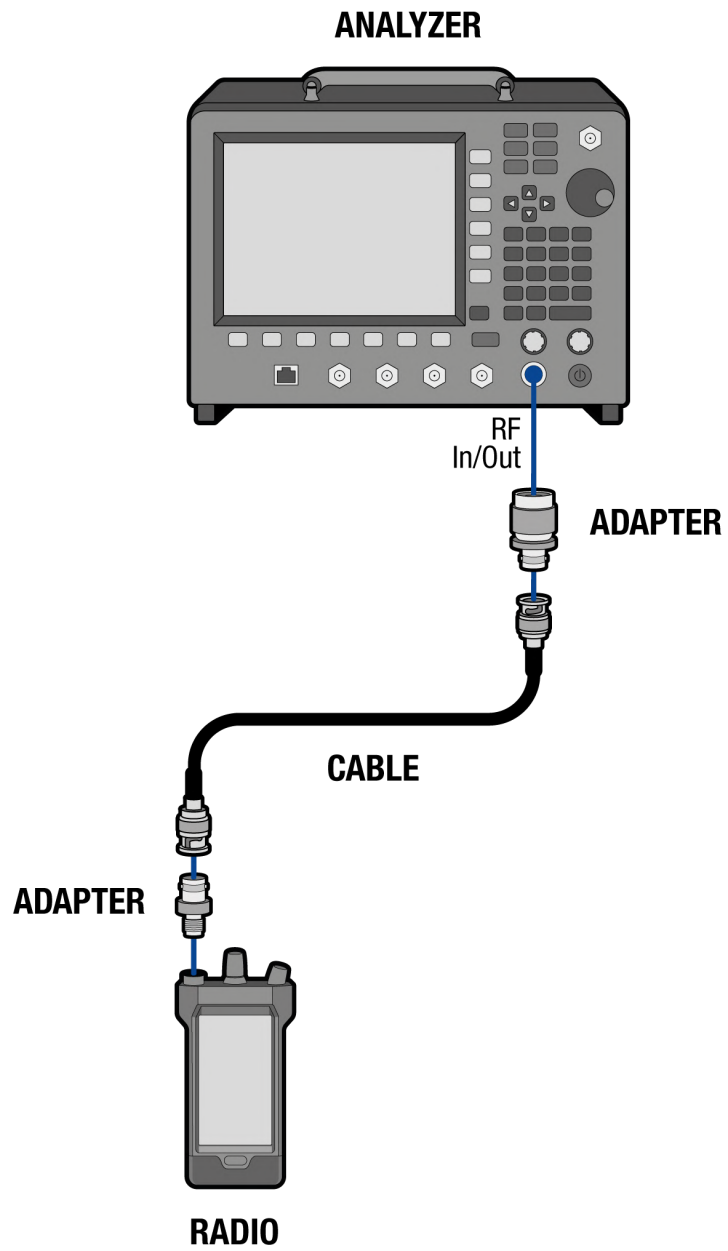

Procedure

Steps	Actions	Notes
1. Configure the test setup.	<ul style="list-style-type: none"> a. Connect the Type N(f)-to-BNC(f) adapter to the R8200's RF In/Out port. b. Remove the antenna from the radio. c. Connect the SMA(f)-to-BNC(f) Adapter to the Antenna port of the radio. d. Connect the BNC cable between the radio and the R8200. 	
2. Configure the R8200.	<ul style="list-style-type: none"> a. To access the dPMR Test Mode, press Test > Test Mode > DPMR. b. Press Monitor. c. To set the receiver Center Frequency to match the radio transmitter, press Hot Key 1 > Monitor Frequency > 413 > MHz. d. In the RF Zone, confirm that Mon Port displays RF In/Out as the receiver's input. 	<p>This opens the dPMR Test Mode.</p> <p>Alternatively, press RF Zone > Monitor Frequency > 413 > MHz.</p> <p>If not, press Mon Port > RF In/Out > Enter.</p>
3. Activate and key the radio.	<ul style="list-style-type: none"> a. Turn the On/Off/Volume Knob clockwise to activate the radio. b. Press PTT on the portable. 	<p>This initiates a broadcast of the voice content picked up by the radio microphone.</p>
4. Observe the DISPLAY Zone.	<ul style="list-style-type: none"> a. Press Hot Key 2 > Select Display > Eye Diagram. 	<p>You should observe change in the deviation of the carrier at the symbol</p>

Steps	Actions	Notes
	<ul style="list-style-type: none"> b. Confirm that the analyzer is decoding. 	decision times as measured in the post detection filter. The tighter the transitions are to the target crossing points the better the modulator performance
5. Observe the RF Zone.	<ul style="list-style-type: none"> a. Confirm that the Input Level displays the radio's output as <i>approximately 3 W</i>. b. Confirm that the Freq Error displays the radio's frequency error as less than 100 Hz. 	This verifies the performance of the radio's RF transmitter.
6. Observe the dPMR Zone.	<ul style="list-style-type: none"> a. Confirm that Mod Fidelity displays <i>less than 1%</i>. b. Confirm that Symbol Dev displays <i>less than 2 kHz</i>. 	Having confirmed these transmission parameters, you can verify that the transmitter on this radio is working properly in dPMR Test Mode.
7. Configure the R8200 for Voice loopback.	<ul style="list-style-type: none"> a. Disable PTT on radio. b. To set the transmitter Generate Frequency to match the radio receiver, press Hot Key 1 > Copy Frequency to Generator. c. To setup Voice loop transmitting RF from the R8200, press Hot Key 4 > Voice Loopback > On. d. To enable voice loop, press the PTT on the radio and speak into the radio. e. Release PTT after about 5 seconds of transmission. 	A status bar in the Voice loop setup screen will highlight as transmission continues. When the bar reach 100% the voice loop recording is complete.
8. Listen for the returned voice broadcast from the radio's speaker.	<ul style="list-style-type: none"> a. Adjust the volume of the voice loop using the radio's On/Off/Volume Knob. 	This verifies that the radio correctly decodes the dPMR broadcast content.

Having confirmed these parameters, you can verify that the transceiver on this radio is working properly in dPMR Test Mode.

Introducing P25 Phase 2 Mode

The optional R8200 P25 II Test Mode allows testing of APCO Project 25 phase 2 compliant mobile stations (radios) and base stations (repeaters) in simplex test mode. P25 phase 2 stations use a two-slot TDMA digital transmission format and modulation schemes compliant with the TIA-102.BBAB specification. The quaternary baud rate is 6000 symbols per second. Phase 2 radios employ Harmonized Continuous Phase Modulation (HCPM) with practically constant amplitude envelope and insignificant Inter-Symbol Interference (ISI) for inbound traffic channels. Phase 2 repeaters employ Harmonized Differential Quadrature Phase Shift Keyed modulation (HDQPSK) with varying amplitude envelope and insignificant ISI for outbound traffic channels. The R8200 provides a grouping of test functions for the asymmetrical superframe structure that are compliant with the TIA-102.CCAA measurement standard. These include RF Slot Power, Power Envelope/Timing, Symbol Rate, Symbol Deviation, Modulation Fidelity, Frequency Error and Deviation, Bit Error Rate (BER), and test pattern generator. In addition, Eye Diagram, Distribution Plot, Frequency Constellation, and Power Profile displays are provided.

The 180-symbol TDMA slots (0 and 1) form a 60 ms frame, six frames form a 360 ms superframe, and four superframes form a 1.44 second ultraframe. Two logical channels (LCH0 and LCH1) are allocated in the physical slots (1st | 2nd) in an asymmetrical superframe for use in all over-the-air communications as illustrated in the table below. An inbound slot is used only if its logical channel is active; the unused slot may be called a null slot because it does not contain transmitter power. However, both outbound slots are transmitted even if neither logical channel is active. Testing of both logical channels is supported by the R8200. The logical channels are listed below.

Frame	1		2		3		4		5		6	
Outbound LCHn	0	1	0	1	0	1	0	1	0	1	1	0
Inbound LCHn	1	0	1	0	1	0	1	0	1	0	0	1

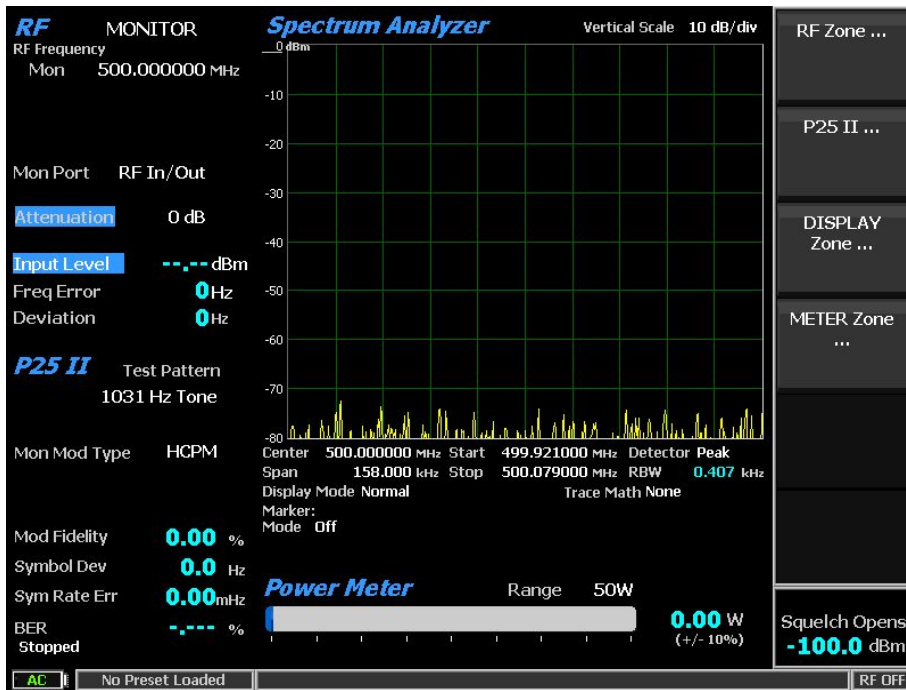

Pressing **Test > Test Mode > P25 II** configures the R8200 for P25 Phase 2 protocol testing, as shown above. On the R8200 main display, the Standard mode’s AUDIO Zone and associated soft keys are replaced by the P25 II Zone and P25 II-specific soft keys (accessed by pressing the **P25 II** soft key).

NOTE

The manufacturer’s Radio Service Software (RSS) is required to perform some tests because certain measurements (e.g., BER, Symbol Rate) require placing the radio in a special test mode. Although TIA measurement methods assume that the transceiver is in Test Mode, most R8200 test functions will work with a live signal. Averaging can be applied to some measurements by the System Settings.

The RF Zone

In P25 II Test Mode, the RF Zone displays parameters associated with the P25 Phase 2 carrier stimulus generated by the R8200 as well as measurements of the RF transmissions received from the radio under test. The RF Zone during

P25 Phase 2 transmitter testing (with the R8200 in Monitor Mode) is shown on the left while the RF Zone during P25 Phase 2 receiver testing (with the R8200 in Generate Mode) in the center, and Duplex Mode is shown on the right, below.



During P25 II Test Mode, the RF Zone offers the following measurement displays:

Input Level – Displays the average power in the logical channel under test.

NOTE

Although Input Level is used for Squelch, Squelch has no effect on measurement updates.

When the RF input power on the RF In/Out port is above +20 dBm (100 mW), the R8200 utilizes a broadband power detector for the measurement. The Input Level field in the RF Zone changes to Watt Meter to indicate this measurement mode. For best accuracy, disable the Pre-amplifier in Monitor Mode and set the Gen Port in Generate Mode to RF In/Out. The Input Source parameter can be used to force narrow or broadband power. That is useful for TDMA protocols whose on and off slots can cause the indicator to toggle between them.

Watt Meter – Displays the level of broadband power applied to the RF In/Out port when the RF input power on the RF In/Out port is above +20 dBm (100 mW).

Freq Error – Displays the frequency difference of the received transmission carrier minus the R8200 Monitor Frequency.

Deviation – Displays the positive peak frequency deviation of the received modulated carrier (i.e., from the Frequency Error mean). See negative peak frequency deviation with DISPLAY Zone Bar Graphs.

While the analyzer is operating in P25 II Test Mode, the RF Zone soft key menus contain all of the parameter settings for the controlling the R8200 RF output. For a complete soft key reference for the RF Zone, see ["RF Zone Soft Keys for Duplex Mode" on page 462](#).

The P25 II Zone

While operating in P25 II Test Mode, the AUDIO Zone and associated soft keys are replaced by the P25 II Zone and P25 II specific soft keys. The P25 II Zone displays the physical layer parameters that can be configured to encode and decode P25 Phase 2 content. The P25 II Zone is shown in Monitor Mode on the left, Generate Mode in the middle, and Duplex Mode on the right, below.



The P25 II Zone offers the following measurement displays:

Mod Fidelity – Modulation Fidelity represents how accurate a P25 transmitter reproduces an ideal theoretical modulation waveform. The measurement is performed by first removing frequency error and symbol deviation gain error from the received signal, then computing the RMS difference between the deviation of the resulting signal at each symbol decision point and the ideal deviations of those symbols; no bit errors should exist. On the R8200, this is computed over a symbol interval (180 for HDQPSK; 164 for HCPM) and reported as an RMS error in % normalized across symbols.

Symbol Dev – This selection displays the symbol deviation estimated by averaging the normalized frequency deviations (of the FM representation of the phase-based modulation) at symbol times in the received signal and then scaling by the maximum symbol value. The normalized frequency deviation is computed as the ratio of the actual

frequency measurement at a given symbol or deviation state by the corresponding symbol value. The HCPM ideal is 2992 Hz; since symbol decisions are based on 60° phase changes, they do not correspond to four frequency deviations. The HDQPSK ideal is 2250 Hz.

Bits	Symbol	HCPM Carrier Frequency Deviation	HDQPSK Carrier Frequency Deviation	Phase Deviation
01	+3	+2992 Hz	+2250 Hz	+135°
00	+1	+997 Hz	+750 Hz	+45°
10	-1	-997 Hz	-750 Hz	-45°
11	-3	-2992 Hz	-2250 Hz	-135°

Sym Rate Err – Displays the percentage of bit differences between the bits of the Test Pattern and the bits from the received synchronized TDMA signal. This bit error rate test checks the modulation, encoding, and timing of the transmit signal during the data transmission period. When performing the BER Test, the radio transmitter under test must be placed into a test diagnostic mode with the correct TX test pattern selected using the manufacturer’s Radio Service Software (RSS). The test is done at nominal power with the radio transmitting the test pattern into the service monitor. It is acceptable to have an attenuator between the radio under test and the service monitor.

BER – Displays the percentage of bit differences between the bits of the Test Pattern and the bits from the received synchronized TDMA signal. This bit error rate test checks the modulation, encoding, and timing of the transmit signal during the data transmission period. When performing the BER Test, the radio transmitter under test must be placed into a test diagnostic mode with the correct TX test pattern selected using the manufacturer’s Radio Service Software (RSS). The test is done at nominal power with the radio transmitting the test pattern into the service monitor. It is acceptable to have an attenuator between the radio under test and the service monitor.

While the analyzer is operating in P25 II Test Mode, the P25 II Zone soft key menus contain all of the R8200 parameter settings for the controlling the P25 Phase 2 physical layer. For a complete soft key reference for the P25 II Zone, see ["P25 II Zone Soft Keys" on page 743](#).

The DISPLAY Zone

During P25 II Test Mode, the DISPLAY Zone offers a Spectrum Analyzer, Oscilloscope, Bar Graphs, Eye Diagram, and a Distribution Plot, accessed by pressing **Select Display**, as shown in the horizontal soft key menu below.



Spectrum Analyzer

See "Introducing the Spectrum Analyzer" on page 93.

Oscilloscope

See "Introducing the Oscilloscope" on page 96.

Bar Graphs

See "Bar Graphs" on page 80.

Eye Diagram

See "Eye Diagram" on page 157.

Distribution Plot

See "Introducing PROJECT 25 Test Mode" on page 168.

While the analyzer is operating in P25 II Test Mode, the DISPLAY Zone soft key menus contain all of the parameter settings for RF and baseband measurement display. For DISPLAY Zone soft keys unique to P25 II Test Mode, see **"DISPLAY Zone Soft Keys for P25 Phase 2 Transmitter Test" on page 745**. For a complete soft key reference for the DISPLAY Zone, see **"DISPLAY Zone Soft Keys for Duplex Mode" on page 496**.

The METER Zone

In P25 II Test Mode, the METER Zone is preloaded with a Power Meter.

A Voltmeter and Constellation Meter are also available by pressing **Hot Key 5 > Select Meter** and choosing the desired meter, as shown below.

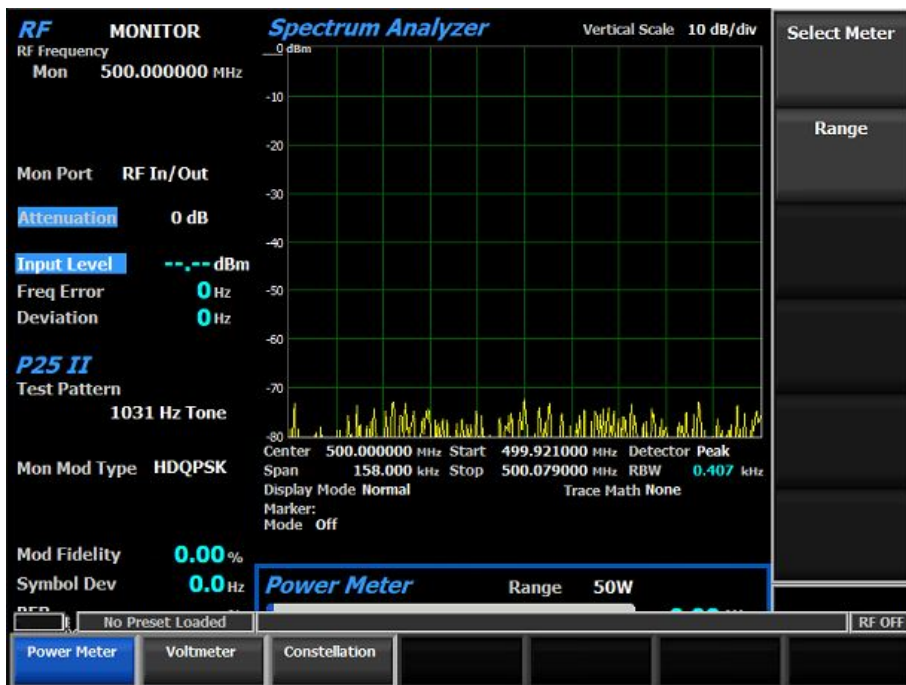

Power Meter

See **"Power Meter" on page 100**.

Voltmeter

See **"Voltmeter" on page 101**.

Constellation Meter

See **"Constellation Meter" on page 161**.

While the analyzer is operating in P25 II Test Mode, the METER Zone soft key menus contain all of the parameter settings for RF and baseband measurement metering. For METER Zone soft keys unique to P25 II Test Mode, see **"P25 II Zone Soft Keys" on page 743**. For a complete soft key reference for the METER Zone, see **"METER Zone Soft Keys for Monitor Mode" on page 401**.

Introducing PTC-ITCR Mode

The optional R8200 PTC-ITCR Test Mode allows testing of cab, wayside, and base radios compliant with the Positive Train Control-Interoperable Train Control Radio standard. PTC-ITCR uses a radio network known as Interoperable Train Control Radio (ITCR) that operates from 217.6 MHz to 222 MHz using 25 kHz channels. The physical layer consists of a $\pi/4$ DQPSK waveform providing bit rates of 16 kilobits per second (kbps) at the full rate and 8 kbps at the half rate in a 25 kHz channel managed by Time Division Multiple Access (TDMA) technology. The network consists of three types of radios: locomotive radios positioned in the cab of each locomotive, wayside radios positioned along the edge of the railroad tracks and 75-watt base radios. The R8200 PTC-ITCR Test Mode provides signals and measurements compliant with the PTC-ITCR protocol. These include RF Input Power, Frequency Error and Deviation, Peak Envelope Power, Average Power, Peak-to-Average Ratio, Error Vector Magnitude, Magnitude Error, IQ Imbalance, Phase Error, and Bit Error Rate (BER) with test pattern. In addition, a Spectrum Analyzer, Eye Diagram, Power Profile, Constellation Plot, and a Distribution Plot are provided.

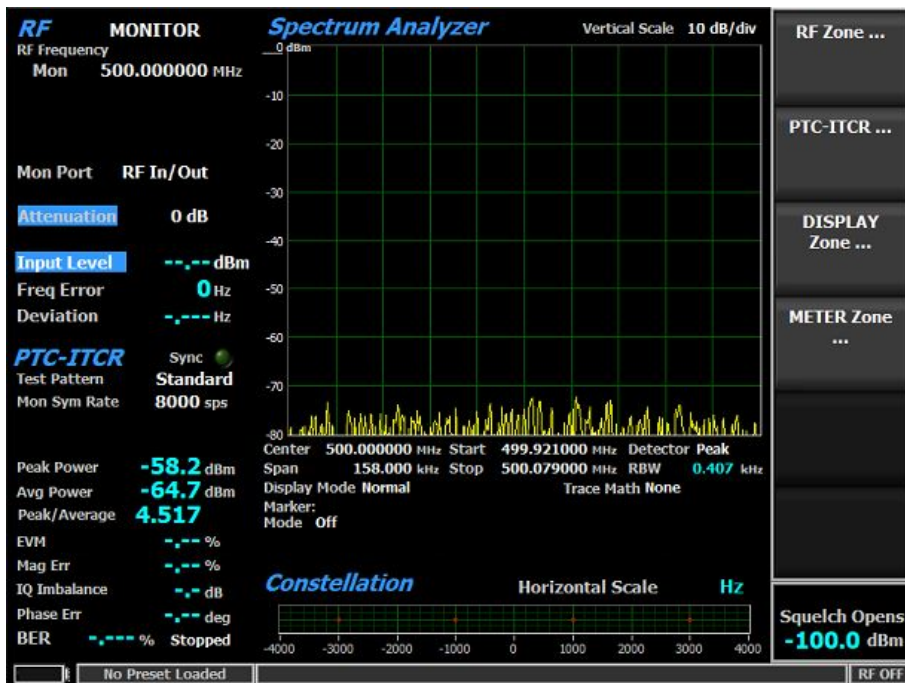

Pressing **Test > Test Mode > PTC-ITCR** configures the R8200 for PTC-ITCR protocol testing, as shown above. On the R8200 main display, the Standard mode's AUDIO Zone and associated soft keys are replaced by the PTC-ITCR Zone and PTC-ITCR-specific soft keys (accessed by pressing the **PTC-ITCR** soft key).

NOTE

The manufacturer's Radio Service Software (RSS) is required to perform some tests in PTC-ITCR because certain measurements (BER) require placing the radio in a special test mode. Tests that do not require RSS include RF Input Power, Frequency Error and Deviation, Peak Envelope Power, Average Power, Peak-to-Average Ratio, Error Vector Magnitude, Magnitude Error, IQ Imbalance, and Phase Error. Averaging can be applied to some measurements by the System Settings. The Spectrum Analyzer, Eye Diagram, Power Profile, Constellation Plot, and Distribution Plot also provide qualitative indication of the radio's performance.

The RF Zone

In PTC-ITCR Test Mode, the RF Zone displays parameters associated with the PTC-ITCR carrier stimulus generated by the R8200 as well as measurements of the RF transmissions received from the radio under test. The RF Zone during PTC-ITCR transmitter testing and receiver testing with the R8200 in Duplex Mode is shown below.

RF		DUPLEX	
RF Frequency			
Mon	220.000000	MHz	
Gen	220.000000	MHz	
Output Level	-50.0	dBm	
	-50.0	dBm	
Mon Port	RF In/Out		
Gen Port	RF In/Out		
Attenuation	12	dB	
Input Level	--.--	dBm	
Freq Error	0	Hz	
Deviation	-.---	Hz	

During PTC-ITCR Test Mode, the RF Zone offers the following measurement displays:

Input Level – Displays the average power in the specified Burst of the synchronized TDMA slot of the received signal.

NOTE

Although Input Level is used for Squelch, Squelch has no effect on measurement updates.

When the RF input power on the RF In/Out port is above +20 dBm (100 mW), the R8200 utilizes a broadband power detector for the measurement. The Input Level field in the RF Zone changes to Watt Meter to indicate this measurement mode. For best accuracy, disable the Pre-amplifier in Monitor Mode and set the Gen Port in Generate Mode to RF In/Out.

Watt Meter – Displays the level of broadband power applied to the RF In/Out port when the RF input power on the RF In/Out port is above +20 dBm (100 mW).

Freq Error – Displays the difference between the received PROJECT 25 Trunk carrier frequency and the R8200 Monitor Frequency.

Deviation – Displays the negative and positive peak frequency deviation of a modulated carrier (i.e., from the Frequency Error mean), available when Modulation Mode is FM.

While the analyzer is operating in PTC-ITCR Test Mode, the RF Zone soft key menus contain the parameter settings for the controlling the R8200 RF output. For a complete soft key reference for the RF Zone, see ["RF Zone Soft Keys for Duplex Mode" on page 462](#).

The PTC-ITCR Zone

While operating in PTC-ITCR Test Mode, the AUDIO Zone and associated soft keys are replaced by the PTC-ITCR Zone and PTC-ITCR-specific soft keys. The PTC-ITCR Zone displays the physical layer parameters that can be configured to encode and decode PTC-ITCR content. The PTC-ITCR Zone is shown in Duplex Mode below.

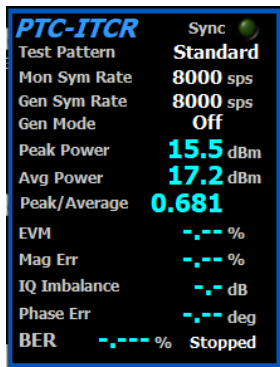

The PTC-ITCR Zone offers the following measurement displays:

Peak Power – Peak envelope power of the modulation envelope.

Avg Power – The RMS power of the modulation envelope.

EVM (RMS) – Deviation of the actual signal (I/Q vectors) from the ideal signal, as depicted by the red arrow in the image below.

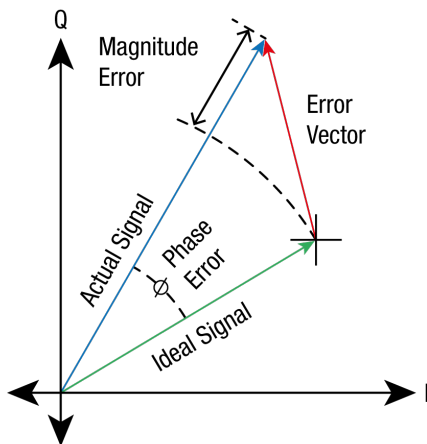

The ideal PTC-ITCR signal consists of eight points around the origin. From these, the deviations are measured to all actual points closest to each. In terms of the constellation, it is the distance from the ideal to the actual symbol. The measurement is done at the optimal symbol times and positions to exclude adverse effects of frequency error and residual carrier. The RMS error vector magnitude for a burst is the square root of the sum of the squares of the error distances divided by the number of symbols in the burst.

Mag Err – The difference between the magnitude of the measured signal versus the magnitude of the ideal signal, see above.

IQ Imbalance – Difference between quadrature and in-phase components of the transmitted signal from the radio under test.

Phase Err – Difference in phase between the transmitted and received carrier.

BER – Displays the percentage of bit differences between the bits of the Test Pattern and the bits from the received synchronized TDMA signal. This bit error rate test checks the modulation, encoding, and timing of the transmit signal during the data transmission period. When performing the BER Test, the radio transmitter under test must be placed into a test diagnostic mode with the correct TX test pattern selected using the manufacturer’s Radio Service Software (RSS). The test is done at nominal power with the radio transmitting the test pattern into the service monitor. It is acceptable to have an attenuator between the radio under test and the service monitor.

While the analyzer is operating in PTC-ITCR Test Mode, the PTC-ITCR Zone soft key menus contain all of the R8200 parameter settings for the controlling the PTC-ITCR physical layer. For a complete soft key reference for the PTC-ITCR Zone, see ["PTC-ITCR Zone Soft Keys" on page 759](#).

The DISPLAY Zone

During PTC-ITCR Test Mode, the DISPLAY Zone provides a Spectrum Analyzer, Eye Diagram, Power Profile, Constellation Plot, and a Distribution Plot, accessed by pressing **Select Display**, as shown in the horizontal soft key menu below.



Spectrum Analyzer

See ["Introducing the Spectrum Analyzer"](#) on page 93.

Eye Diagram

See ["Eye Diagram"](#) on page 157.

Power Profile

See ["Power Profile"](#) on page 158.

Constellation Plot

See "Introducing PROJECT 25 Test Mode" on page 168.

Distribution Plot

See "Introducing PROJECT 25 Test Mode" on page 168.

While the analyzer is operating in PTC-ITCR Test Mode, the DISPLAY Zone soft key menus contain all of the parameter settings for RF and baseband measurement display. For DISPLAY Zone soft keys unique to PTC-ITCR Test Mode, see "PTC-ITCR Zone Soft Keys" on page 759. For a complete soft key reference for the DISPLAY Zone, see "DISPLAY Zone Soft Keys for Duplex Mode" on page 496.

The METER Zone

In PTC-ITCR Test Mode, the METER Zone is preloaded with a Constellation Meter.

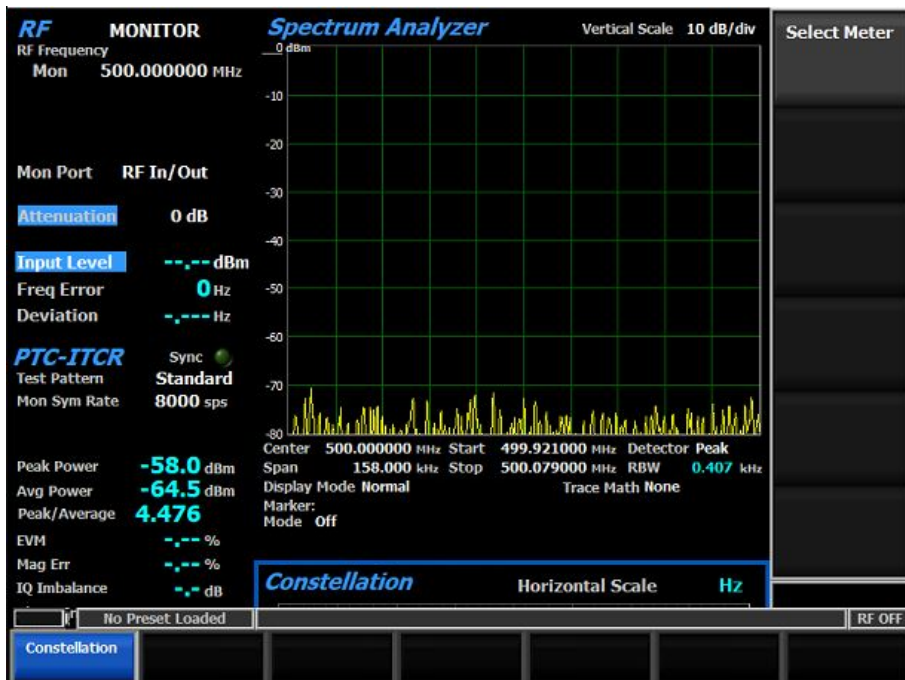

Constellation Meter

The Constellation Meter provides a visual representation of overall transmitter performance, as shown below.

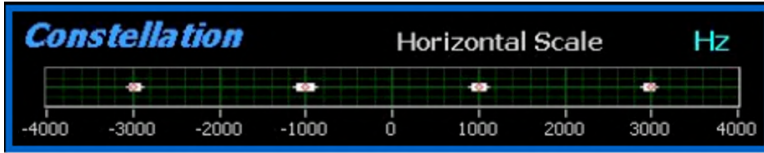

PTC-ITCR radios broadcast voice and data using four frequency shift deviations of the carrier to represent symbols containing two data bits. Four red tick marks on the display represent the expected locations for the deviation states when the radio is transmitting data bit symbols using the modulation. White tick marks show the actual deviation measurement at symbol decision times. A tighter grouping around the red tick marks indicates more accurate transmitter performance.

The nominal deviation points for each data symbol are as follows:

Bits	Symbol	Deviation
01	+3	+3000 Hz
00	+1	+1000 Hz
10	-1	-1000 Hz
11	-3	-3000 Hz

While the analyzer is operating in PTC-ITCR Test Mode, the METER Zone soft key menus contain all of the parameter settings for RF and baseband measurement metering. For METER Zone soft keys unique to PTC-ITCR Test Mode, see **"PTC-ITCR Zone Soft Keys" on page 759**. For a complete soft key reference for the METER Zone, see **"METER Zone Soft Keys for Monitor Mode" on page 401**.

To become familiar with using the R8200 to observe PTC-ITCR signals, turn to **"Using PROJECT 25 Test Mode" on page 183**.

Using PTC-ITCR Test Mode

This section provides an example measurement using the analyzer's PTC-ITCR Test Mode. Complete this procedure to gain an understanding of the test setup and available measurements without the use of an ITCR radio. This procedure will utilize the R8200 transmitting ITCR signals to itself as a demonstration of measurement functionality. For testing an actual ITCR radio, see Freedom Application Note FCT-1012 at FreedomCTE.com.

PTC-ITCR Demonstration

This section describes a simple procedure to demonstrate the basic functionality of the PTC-ITCR Test Mode and its available measurements.

Required Equipment

- Freedom R8200 Communications System Analyzer
- Cable, coax, BNC (m-m)

Test Setup

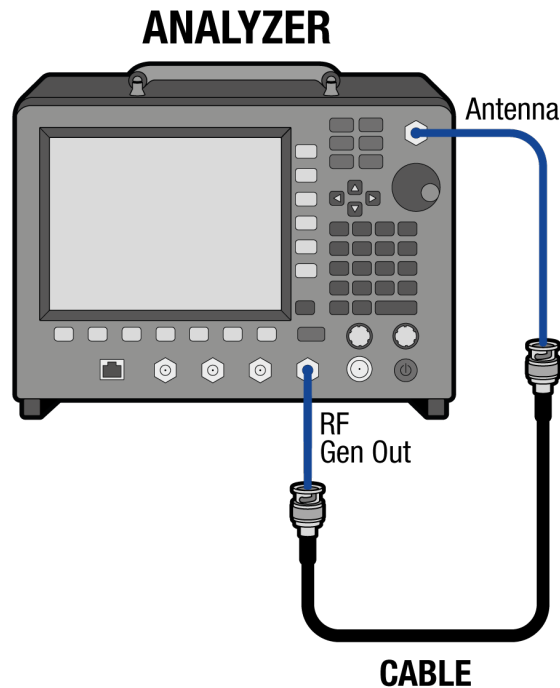

Procedure

Steps	Actions	Notes
1. Configure the test setup.	a. Connect the BNC cable from Gen Out port to Antenna port on the R8200.	This will be a loopback test for demonstration purposes only.
2. Configure the R8200.	<p>a. Press Duplex.</p> <p>b. To set the receiver Center Frequency press Hot Key 1 > Monitor Frequency > 219 > MHz.</p> <p>c. In the RF Zone, confirm that Mon Port displays Antenna as the receiver's input.</p> <p>d. To set the Generate Frequency press Hot Key 1 > Generate Frequency > 219 > MHz.</p> <p>e. In the RF Zone, to change the Gen Port, press Gen Port > Gen Out > Enter.</p> <p>f. For this demonstration, use Automatic Attenuation.</p> <p>g. To access the PTC-ITCR Test Mode, press Test > Test Mode > PTC-ITCR.</p>	<p>Alternatively, press RF Zone > Monitor Frequency > 219 > MHz.</p> <p>If not, press Mon Port > Antenna > Enter.</p> <p>For actual live radio testing, automatic attenuation often works without issue. However, for TDMA signals (as in PTC-ITCR) set a fixed attenuation value of 30 dB or more.</p>
3. Activate the transmitted modulation.	<p>a. To select the PTC-ITCR Zone, press Hot Key 4.</p> <p>b. To broadcast the PTC-ITCR signal, press Modulation Mode > Continuous.</p> <p>c. Observe the Signal Analyzer and</p>	<p>This broadcasts the PTC-ITCR signal back into the R8200.</p> <p>The PTC-ITCR baseband content is inaudible data, so there is no tone to hear.</p>

Steps	Actions	Notes
	confirm the PTC-ITCR signal at 219 MHz.	
4. Observe the PTC-ITCR Zone.	a. In the PTC-ITCR Zone, confirm that the green Sync indicator is illuminated.	The analyzer is decoding the radio's transmitted data.
5. Observe the PTC-ITCR signal.	a. To view the PTC-ITCR signal in the Eye Diagram, press Hot Key 2 > Select Display > Eye Diagram . b. Confirm the PTC-ITCR signal in the Eye Diagram.	The Eye Diagram should display 4 groupings of symbol decision points.
6. Observe the Power Profile.	a. Press Select Display > Power Profile . b. To adjust the Vertical Maximum to bring the power ramps into view, press Vertical Maximum and adjust the Tuning Knob to bring the signal into view. c. Press Horizontal Start to adjust forward or backward (–100 ms) the displayed start relative to slot 0. d. Press Horizontal Maximum to adjust the displayed time to 1000 ms.	The slot time of the test signal is 50 ms, so the power profile display will show 20 slots in 1000 ms. This test signal is even slots only. Overshoot will be seen more clearly on an actual radio and the not test signals provided here. Horizontal Maximum can be adjusted out to 4000 ms (1 Superframe of the ITCR transmission). Vertical Scale and Vertical Maximum can be adjusted to enable viewing of the transmitter's ramp up and overshoot .

For a detailed verification test procedure using an actual ITCR radio, contact the Freedom sales team and request a copy of Freedom Application Note FCT-1012.

Introducing PTC-ACSES Test Mode

The optional R8200 PTC-ACSES Test Mode allows testing of conventional (non-trunked) Advanced Civil Speed Enforcement System (ACSES). PTC-ACSES uses a radio network that operates from 217.0 MHz to 221.9875 MHz. The physical layer consists of a GMSK waveform providing a raw bit rate of 9.6 kilobits per second (kbps) 12.5 kHz channel managed by Time Division Multiple Access (TDMA) technology. The network consists of two types of radios: on-board (locomotive radios positioned in the cab of each locomotive) and wayside radios (interlocking and right of way infrastructure). The R8200 PTC-ACSES Test Mode provides signals and measurements compliant with the PTC-ACSES protocol. These include RF Input Power, Frequency Error and Deviation, test patterns for Bit Error Rate, Packet Error Rate, and Packets-Per-Second, as well as Peak Envelope Power, Average Power, Peak-to-Average Ratio, Symbol Rate Error, and Symbol Deviation measurements. In addition, a Spectrum Analyzer, Eye Diagram, Power Profile, Slot Map are provided.

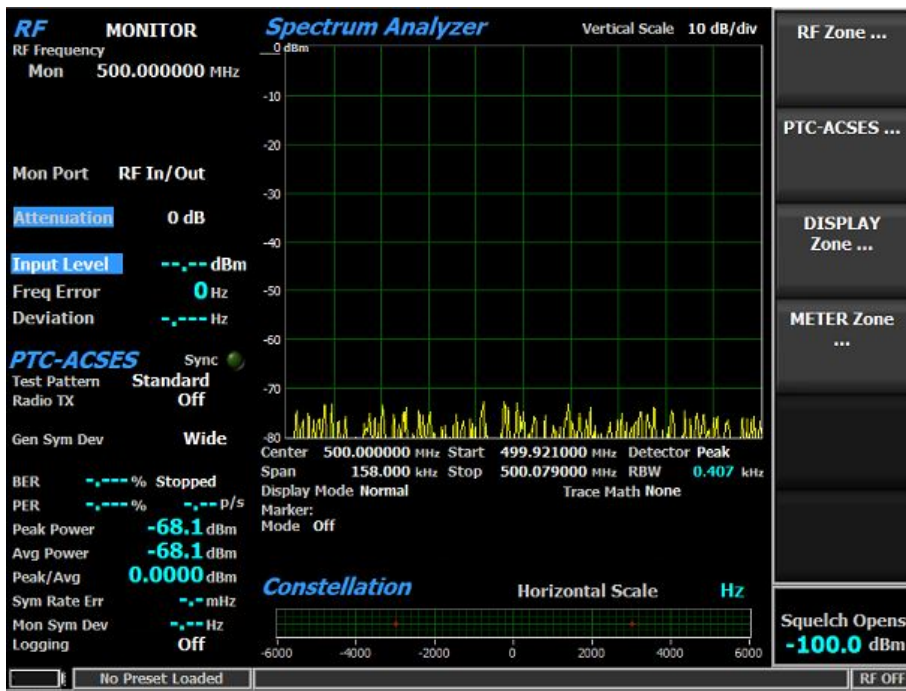

Pressing **Test > Test Mode > PTC-ACSES** configures the R8200 for PTC-ACSES protocol testing, as shown above. On the R8200 main display, the Standard mode's AUDIO Zone and associated soft keys are replaced by the PTC-ACSES Zone and PTC-ACSES-specific soft keys (accessed by pressing the PTC-ACSES soft key).

NOTE

The manufacturer's Radio Service Software (RSS) is required to perform some tests in PTC-ACSES Mode because certain measurements (BER) require placing the radio in a special test mode. Tests that do not require RSS include power include Frequency Error and Deviation, Peak Envelope Power, Average Power, Peak-to-Average Ratio, Symbol Rate Error, and Symbol Deviation. Averaging can be applied to some measurements by the System Settings. The Eye Diagram, Power Profile, and Slot Map also provide qualitative indication of the radio's performance.

The RF Zone

In PTC-ACSES Test Mode, the RF Zone displays parameters associated with the PTC-ACSES carrier stimulus generated by the R8200 as well as measurements of the RF transmissions received from the radio under test. The RF Zone during PTC-ACSES transmitter testing (with the R8200 in Monitor Mode) is shown on the left while the RF Zone during PTC-ACSES receiver testing (with the R8200 in Duplex Mode) is shown on the right, below.

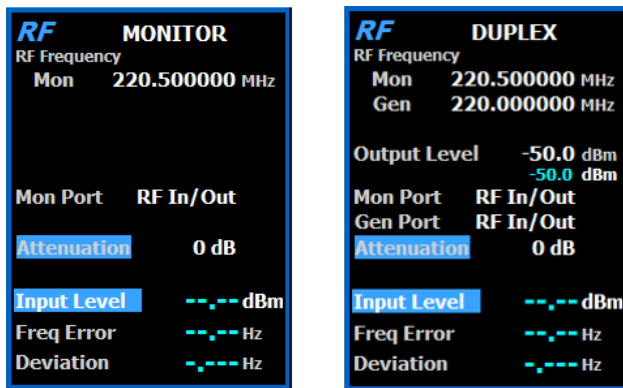

During PTC-ACSES Test Mode, the RF Zone offers the following measurement displays:

Input Level – Displays the average power in the specified burst of the synchronized TDMA slot for the transmitted signal.

NOTE

Although Input Level is used for Squelch, Squelch has no effect on measurement updates.

When the RF input power on the RF In/Out port is above +20 dBm (100 mW), the R8200 utilizes a broadband power detector for the measurement. The Input Level field in the RF Zone

changes to Watt Meter to indicate this measurement mode. For best accuracy, disable the Pre-amplifier in Monitor Mode and set the Gen Port in Generate Mode to RF In/Out.

The TDMA transmission alternates between a used and unused time slot, so the RF Zone field will switch between the two. An unused slot has no power, so the display will flash between Input Level and Watt Meter. In this condition the Input Level reading should be used since null slots can cause the Watt Meter indication to read approximately 3 dB less than the power in the used slots.

Freq Error – Displays the difference between the received PTC-ACSES carrier frequency and the R8200 Monitor Frequency.

Deviation – Displays the negative and positive peak frequency deviation of a modulated carrier (i.e., from the Frequency Error mean), available when Modulation Mode is FM.

While the analyzer is operating in PTC-ACSES Test Mode, the RF Zone soft key menus contain all of the parameter settings for the controlling the R8200 RF output. For a complete soft key reference for the RF Zone, see "[RF Zone Soft Keys for Duplex Mode](#)" on page 462.

The PTC-ACSES Zone

While operating in PTC-ACSES Test Mode, the AUDIO Zone and associated soft keys are replaced by the PTC-ACSES Zone and PTC-ACSES-specific soft keys. The PTC-ACSES Zone displays the physical layer parameters that can be configured to encode and decode PTC-ACSES content. The PTC-ACSES Zone is shown in Duplex Mode below.

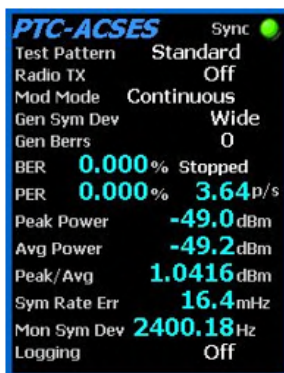

The PTC-ACSES Zone offers the following measurement displays:

BER – Bit Error Rate in %, calculated from 0.153 test pattern in the incoming RF packets.

PER – Packet Error Rate in % calculated from 0.153 test pattern in the incoming RF packets. Any bit error in a packet labels the packet as failed.

p/s – Reports the number of packets received each second (packets-per-second).

Peak Power – Peak envelope power of the modulation envelope.

Avg Power – RMS power of the modulation envelope.

Peak/Avg – Peak to Average power ratio.

Sym Rate Err – Symbol Rate Error (mHz) reports the average error of symbols relative to the expected symbol rate.

Mon Sym Dev – Monitor (RF) Symbol Deviation reports the average deviation of the GMSK symbols.

NOTE

The Monitor Symbol Deviation reported in the PTC-ACSES Zone is the correct measurement when made using the OTA transmitted test pattern generated by the R8200. This measurement can only be made properly with the Ethernet test payload sent to the radio from the R8200. The test payload contains information about the slot and sequence used for PER calculation, an 0.153 pattern for BER calculation, and a deviation test pattern to correctly measure Symbol Deviation.

Placing an attenuator between the radio under test and the service monitor is acceptable but should not be needed.

While the R8200 is operating in PTC-ACSES Test Mode, the PTC-ACSES Zone soft key menus contain all of the parameter settings for the controlling both the PTC-ACSES RF physical layer and the configuration setup to transmit and receive data with the ACSES radio across the Ethernet port. For a complete soft key reference for the PTC-ACSES Zone, see "[PTC-ACSES Zone Soft Keys for Transceiver Test](#)" on page 765.

The DISPLAY Zone

During PTC-ACSES Test Mode, the DISPLAY Zone offers a Spectrum Analyzer, Eye Diagram, Power Profile, and a Slot Map, accessed by pressing **Select Display**, as shown in the horizontal soft key menu below.



Spectrum Analyzer

See ["Introducing the Spectrum Analyzer"](#) on page 93.

Eye Diagram

See ["Eye Diagram"](#) on page 157.

Power Profile

See ["Power Profile"](#) on page 158.

Slot Map

The RF transmitted from the R8200 to the PTC-ACSES radio is processed across the Ethernet interface and reported on the Slot Map display. The Slot Map displays timeslot error status by slot. For example, timeslot error by slot for a 6 second epoch, below.



NOTE The map updates based on incoming data. If no data is arriving at the Ethernet port, the Slot Map will stop updating and no values will change.

Information available on the Slot Map per slot:

- Gray** – no data received for that slot.
- Green** – Good data received in that slot, no errors.
- Red** – at least 1 error received in that slot since the last reset.

NOTE Detailed Slot Map information is available in the full Application Note available by request at www.freedomcte.com/PTC.

The values within each slot are a cumulative error for that slot in terms of PER or BER, based on the current Data Type selection.

The Slot Map offers the following measurement displays:

Epochs – Number of Epochs received since last reset.

Error Packets – Number of slots with errors since the last reset. A slot error can come from several sources. Typical errors reported include:

- Payload had CRC failure
- Payload had BER failure
- Payload sequence value out of order
- Payload sequence value unknown (no majority)
- Payload slot number not equal to header slot number
- Payload type not as expected
- Payload size not as expected
- Message type not as expected

Lost Packets – The number of missing (unreceived) packets since last reset.

NOTE

Lost packets is a standalone measurement and is not included in PER/Epoch. Due to a built in CRC check in radio, most OTA losses of any type will result in lost packets being reported.

Valid Packets – Number of slots valid (without errors) since last reset.

PER/Epoch – Packet Error Rate for last received Epoch only.

BER/Epoch – Bit Error Rate for last received Epoch only.

NOTE

The Packet Error Rate (PER), and Bit Error Rate (BER) reported in the slot map is based on a test packet sent by an R8200. The values are calculated from the information found in the test packet. The R8200 may be capable of capturing live traffic from a TD220MAX radio but it will *not* be able to perform error analyses of the incoming data from live traffic.

Data Logging

The R8200 supports data logging from both the RF Receive and Ethernet Receive. Data logging is enabled with the PTC-ACSES Zone soft key of the same name. Pressing **Export Logs** sends a snapshot of the current logs to a thumb drive inserted in the R8200 USB port.

Example of Ethernet log:

Date Time	dTime	Lost	H-Slot	P-Slot	P-Type	SEQ#	BER%	CRC?	ERR	RSSI
12/3/2018 8:56	0	0	10	10	2	5	0	1	x0	-60
12/3/2018 8:56	253	0	12	12	2	6	0	1	x0	-60
12/3/2018 8:56	248	0	14	14	2	7	0	1	x0	-60
12/3/2018 8:56	251	0	16	16	2	8	0	1	x0	-60
12/3/2018 8:56	249	0	18	18	2	9	0	1	x0	-60
12/3/2018 8:56	249	0	20	20	2	10	0	1	x0	-60

While the analyzer is operating in PTC-ACSES Test Mode, the DISPLAY Zone soft key menus contain all of the parameter settings for RF and baseband measurement display. For DISPLAY Zone soft keys unique to PTC-ACSES Test Mode, see ["DISPLAY Zone Soft Keys for PTC-ACSES Transceiver Test" on page 771](#). For a complete soft key reference for the DISPLAY Zone, see ["DISPLAY Zone Soft Keys for Duplex Mode" on page 496](#).

The METER Zone

In PTC-ACSES Test Mode, the METER Zone is preloaded with a Constellation Meter.

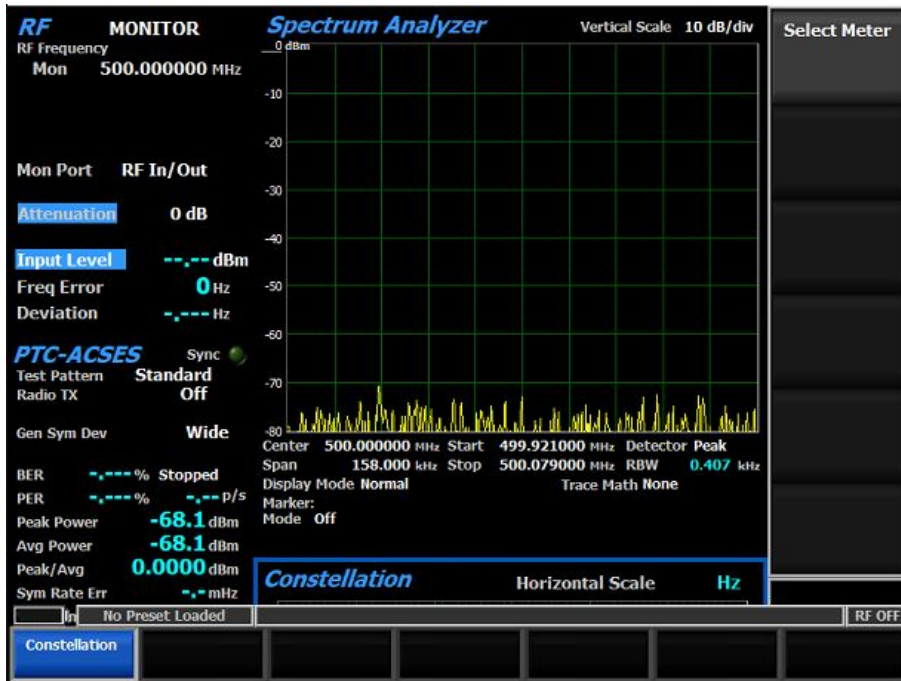

While the analyzer is operating in PTC-ACSES Test Mode, the METER Zone soft key menus contain all of the parameter settings for baseband measurement metering. For METER Zone soft keys unique to PTC-ACSES Test Mode, see **"METER Zone Soft Keys for PTC-ACSES Transceiver Test" on page 772**. For a complete soft key reference for the METER Zone, see **"METER Zone Soft Keys for Monitor Mode" on page 401**.

To become familiar with using the R8200 to observe PTC-ACSES signals, turn to **"Using PTC-ACSES Test Mode" on the next page**.

Using PTC-ACSES Test Mode

This section provides an example measurement using the PTC-ACSES Test Mode. Complete this procedure to gain understand the test setup and available measurements without the use of a TD220 radio. This procedure will utilize the R8200 transmitting ACSES signals to itself as a demonstration of measurement functionality. For testing an actual ACSES radio, see Freedom Application Note FCT 1013 “Testing PTC-ACSES (TD220MAX) Radios Using the Freedom Communications System Analyzers” at FreedomCTE.com.

PTC-ACSES Demonstration

This section describes a simple procedure to demonstrate the basic functionality of the PTC-ACSES Test Mode and its available measurements.

Required Equipment

- Freedom R8200 Communications System Analyzer
- Cable, coax, BNC (m-m)

Test Setup

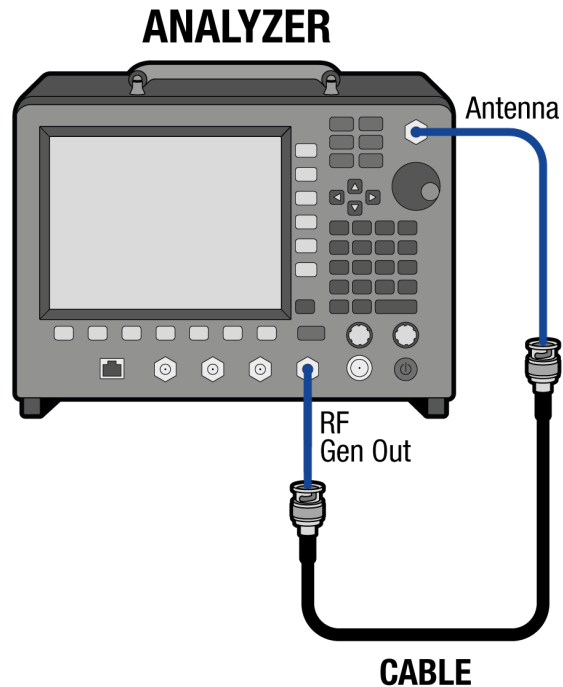

Procedure

Steps	Actions	Notes
1. Configure the test setup.	a. Connect the BNC cable from Gen Out port to Antenna port on the R8200.	This will be a loopback test for demonstration purposes only.
2. Configure the R8200.	a. Press Duplex . b. To set the receiver Center Frequency press Hot Key 1 > Monitor Frequency > 219 > MHz . c. In the RF Zone, confirm that Mon Port displays Antenna as the receiver input.	Alternatively, press RF Zone > Monitor Frequency > 219 > MHz . If not, press Mon Port > Antenna > Enter .

Steps	Actions	Notes
	<p>d. To set the Generate Frequency press Hot Key 1 > Generate Frequency > 219 > MHz.</p> <p>e. In the RF Zone, to change the Gen Port, press Gen Port > Gen Out > Enter.</p> <p>f. For this test it is acceptable to use the default Automatic Attenuation.</p> <p>g. To access the PTC-ACSES Test Mode, press Test > Test Mode > PTC-ACSES.</p>	<p>For actual live radio testing, automatic attenuation often works without issue. However, for TDMA signals (as in PTC-ACSES) set a fixed attenuation value of 30 dB or more.</p>
3. Activate the transmitted modulation.	<p>a. To select the PTC-ACSES Zone, press Hot Key 4.</p> <p>b. To broadcast the PTC-ACSES signal, press Modulation Mode > Continuous.</p> <p>c. Observe the Signal Analyzer and confirm the PTC-ACSES signal at 219 MHz.</p> <p>d. Press Hot Key 2 > More > Reference Level and adjust to -40 dBm to bring signal into view.</p>	<p>This broadcasts the PTC-ACSES signal back into the R8200.</p> <p>The PTC-ACSES baseband content is inaudible data, so there is no tone to hear.</p>
4. Observe the PTC-ACSES Zone.	<p>a. In the PTC-ACSES Zone, confirm that the green Sync indicator is illuminated.</p>	<p>The analyzer is decoding the radio transmitted data.</p>
5. Observe the PTC-ACSES signal.	<p>a. To view the PTC-ACSES signal in the Eye Diagram, press Hot Key 2 > Select Display > Eye Diagram.</p>	<p>The Eye Diagram should display 2</p>

Steps	Actions	Notes
	<ul style="list-style-type: none"> b. Confirm the PTC-ACSES signal in the Eye Diagram. 	groupings of symbol decision points.
6. Observe the Power Profile.	<ul style="list-style-type: none"> a. Press Select Display > Power Profile. b. To adjust the Vertical Maximum to bring the power ramps into view, press Vertical Maximum and adjust the Tuning Knob to bring the signal into view. c. Press Horizontal Start to adjust forward or backward (–100 ms) the displayed start relative to slot 0. d. Press Horizontal Maximum to adjust the displayed time to 1000 ms. 	<p>The slot time of the test signal is 125 ms, so the power profile display will show 8 slots in 1000 ms. This test signal is even slots only.</p> <p>Overshoot will be seen more clearly on an actual radio and the not test signals provided here.</p> <p>Horizontal Maximum can be adjusted out to 6000 ms (1 Superframe of the ACSES transmission). Vertical Scale and Vertical Maximum can be adjusted to enable viewing the transmitter ramp up and overshoot.</p>

For a detailed verification test procedure using an actual PTC-ACSES radio, contact the Freedom sales team and request a copy of Freedom Application Note FCT 1013.

Introducing AutoTune

AutoTune is an optional automated test and alignment software application for manufacturer-specific radios embedded in the R8200. The AutoTune display is shown below.



AutoTune eliminates the need for an external computer, simplifying setup and equipment costs for repeated verification test procedures. A connection between an R8200 USB port and the radio under test controls the radio. The software automatically configures the analyzer and the radio to alleviate most operator intervention during alignment and test activities.

AutoTune performs recommended factory alignment procedures in addition to critical transmitter and receiver performance tests. AutoTune maintains detailed test logs and reports in CSV (comma-separated values) file format. These can be conveniently viewed within the application or exported for further analysis by spreadsheet software and other data manipulation programs. A demonstration version of AutoTune is installed on R8200 analyzers that are not equipped with a functional version.

AutoTune currently supports the following land mobile radio makes and models:

Harris XG-75, XT-100M, P7300, XL-200P

Kenwood NX-706, NX-806 portables and mobiles (using USB programming cables)

Motorola APX 1000 (minus Tx Power Out Alignment), APX 2000, APX 2500, APX 4000, APX 4000 Li, APX 4500, APX 4500 Li, APX 5000, APX 5500, APX 6000, APX 6000B, APX 6000 Li, APX 6500, APX 6500 Li, APX 7000, APX 7000XE, APX 7500, MOTOTRBO, SRX 2200, SRX 2200B, XTL 1500, XTL 2500 , XTL 5000, XTS 1500, XTS 2500, XTS 5000.

Motorola MOTOTRBO series portables and mobiles

Relm BK KNG-PXXX

To learn how to use AutoTune to decrease your LMR servicing costs, see **"Using AutoTune" on page 323**.

For AutoTune soft key definitions, ranges, discrete and default values, and detailed notes, see **"AutoTune Soft Keys" on page 790**.

Using AutoTune

The AutoTune menu enables virtually hands-free verification and adjustment of critical LMR performance characteristics. This example uses a Harris XL 200 portable radio. To use AutoTune follow these steps.

Steps	Actions	Notes
1. Open AutoTune and choose your radio.	<ul style="list-style-type: none">a. Press Test > AutoTune ...b. To identify the operator, press Operator ID.c. Use the arrow keys, tuning knob or the alphanumeric keypad to enter an identifier (up to 16 characters), then press Enter.d. To configure your specific radio, press Radio Make & Model.e. Using the Make and Model dialog, chose Harris XL Portable and press Enter.	
2. Configure the test activity and setup, the start the test.	<ul style="list-style-type: none">a. Configure the test setup per the displayed Harris XL Radio Test Setup diagram, then press Return.b. Press Activity > Test Only > Select All > Start.	
3. Review the test results and log out as operator.	<ul style="list-style-type: none">a. Press Tools > Test Report.b. Review the Test Report, the press Return.c. To log out, press Log Out Operator.	

See **"AutoTune Soft Keys" on page 790** for detailed descriptions of the soft keys in this menu. Each soft key is defined, along with its range, discrete, default, and saved state values.

Introducing AutoScript

AutoScript provides monitor and control (M&C) script execution from within the R8200. Using this feature, repetitive measurements normally requiring several keystrokes can be programmed into plain text scripts and the results written to an exportable log file. *Scripts* are imported into the R8200 using a USB drive and may be combined together to form *procedures*. Procedures can be saved and recalled to run a particular set of scripts. The default AutoScript display is shown below.

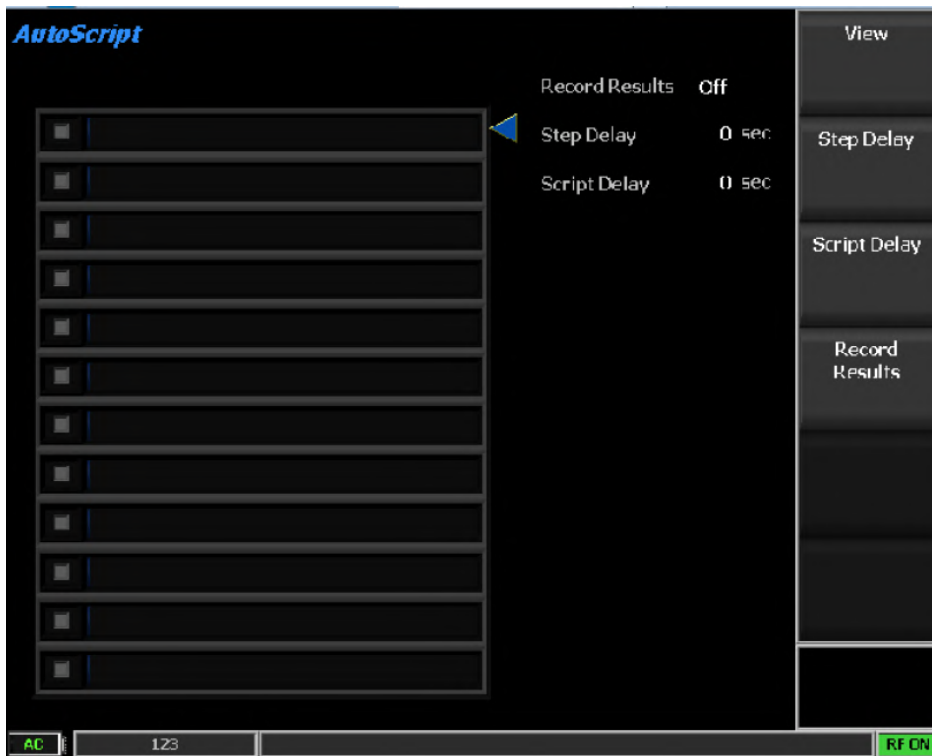

The M&C consists of a set of proprietary commands that supports the IEEE standard equipment ID query. These various commands are used to access the menus and fields that control and report R8200 operation. Commands take the form of:

```
CMD [ Tag [=data] ]
```

If applicable, the Tag consists of the required region (also called the *owner*) of the field along with a specifier. Some fields require that the region is active in order to query or control the data. The specifier identifies the specific field or code being queried or controlled. The region and specifier are joined together with a colon (:) as shown below:

```
DISPLAY : Span
```

The data is only used with write access controls and must be in the appropriate format per the field definition. The square brackets ([]) illustrate these options and are not part of the actual command to be sent.

All commands must be terminated by a carriage-return (CR) and line-feed (LF) character.

Commands

The following table describes the common commands used to configure the R8200.

Command	Usage	Description
NOOP	NOOP	Provides a mechanism for a prompt query without affecting the R8200. Use this command to poll for a response of code 2 (Busy) to determine if a previous command may still be being applied;. See the field description section, Typical Completion Time.
GET	GET <tag>	Retrieves monitored information or current control settings.
SET	SET <tag>=<value>	Sets a control to a new value. If a field using Data Type BOOLEAN has no List Values, then value is F for false or T for true.
DO	DO <tag>	Performs the specified R8200 function.
GO	GO <tag>	Navigate the R8200 menu tree. Some fields are only accessible if the field's required menu is active. In order to monitor or control these fields, use the GO command to navigate to the menu first.

Command	Usage	Description
*IDN?	*IDN?	Queries the the R8200 model number, serial number, and system version.
ERR? and CLEAR	<p>ERR?</p> <p>CLEAR <Tag> [Response]</p> <p>Example Command 1 for Popup Message:</p> <p>ERR?</p> <p>Example Response 1 for Popup Message:</p> <p>0:SYSTEM:6045[POP_CONTINUE,POP_CANCEL] WARNING! Access to USB device. Press Continue to save screen capture to device or Press Cancel to abort.</p> <p>CLEAR SYSTEM:6045 [POP_CONTINUE]</p> <p>0:</p> <p>Example Command 2 for Messages:</p> <p>ERR?</p> <p>Example Response 2 for Messages:</p> <p>0:2[6040,7001]</p> <p>CLEAR</p> <p>0:</p> <p>ERR?</p> <p>0:0[]</p>	<p>Use these commands together to manage the error notification system of the R8200. ERR? queries the R8200 for error information. CLEAR acknowledges error messages and popups. There are two usages based on the response to ERR?. If a popup is active, ERR? will return with the popup tag, a list of valid responses, and the text message of the popup.</p> <p>If no popup is active, the ERR? command will respond with the number of active messages and a list of the message codes.</p>

Command	Usage	Description
HELP	<p>HELP for Commands:</p> <p>HELP <Command></p> <p>HELP for Fields:</p> <p>HELP <Tag></p> <p>HELP for Prompt/Message Code:</p> <p>HELP <code></p> <p>Example Help for Command:</p> <p>HELP SYSTEM:RF</p> <p>Example HELP Response for Command:</p> <p>O:Name:RF Zone Tag:SYSTEM:RF Com- mands:GO Data Type:SUBMENU Typical Completion Time:250 msl </p> <p>By replacing all pipe-bar characters with a CRLF, the result is:</p> <p>O:Name:RF Zone</p> <p>Tag:SYSTEM:RF</p> <p>Commands:GO</p> <p>Data Type:SUBMENU</p> <p>Typical Completion Time:250 ms</p>	<p>Displays limited help information for a command, a specific field, or a brief explanation of a prompt or message code.</p> <p>The field help is formatted to allow users to format the response into a readable body. It contains the pipe-bar character “ ” at each location where a carriage return/line feed (CRLF) should be placed.</p>

Responses

Each command sent to the R8200 using AutoScript shall return a single response. The response consists of a prompt code and colon followed by any returned data. The returned data format depends on the field's data type.

Response Code	Description
0	Success – Command was successful.
1	Ranged – Command was accepted but the data had to be coerced into the valid data range or format.
2	Busy – Command was accepted (i.e. code would have been successful) but previous command was not confirmed complete based on Typical Completion Time.
3	Denied – Access to the requested field was denied. Check field Commands property.
4	N/A – Not available at this time. Check availability requirements.
5	Option – Option not installed. Contact Sales to purchase options.
6	Error – An unexpected error has occurred.
7	Invalid – Command not valid for field. Check field Commands property.
8	Unknown – Tag is unknown. Check Region and Tag.
9	Format – Data is in the wrong format. For example, the field is an INTEGER type but a character string was sent. Check field data type.

Field Properties

Fields are described by their set of properties. This section describes the field properties, valid commands for them, type of data, availability conditions, typical command completion times, etc.

Field Property	Description
Name	The name of the field. It is unused in the protocol but valuable for reference as it corresponds to the label on R8200 soft keys. It is also more descriptive than the tag.
Tag	The tag consists of two parts: the Region, or owner, categorizes the scope of the tag reference; the tag itself specifies the particular field within the region. The format of the Tag is always <code>Region:Tag</code>
Commands	A list of valid M&C commands that may be used with the

Field Property	Description
Data Type	<p data-bbox="815 262 1406 296">field.</p> <p data-bbox="815 310 1406 468">The type of data expected in the <code>SET</code> command string or the data returned from a <code>GET</code> query. All data is passed in text string format, however the string is processed according to the data type:</p> <p data-bbox="815 506 1406 621">Format - Some <code>STRING</code> and <code>Numeric</code> data fields have a specialized format for the data. See "Custom Formats" on page 334.</p> <p data-bbox="815 659 1406 816">Character Set - Some <code>STRING</code> data fields are restricted to the character set that can be used. For example, the <code>DTMF Code</code> has the following defined character set: 0,1,2,3,4,5,6,7,8,9,A,B,C,D,#,*</p> <p data-bbox="815 854 1406 1096">List Values - Both <code>LIST</code> and <code>BOOLEAN</code> data type fields have aliased text strings to make the command/response more readable. These aliases correspond to the horizontal soft key position or position in the list box in the analyzer's soft key menus and parameter dialogs.</p> <p data-bbox="815 1134 1406 1375">Some <code>LIST</code> and <code>BOOLEAN</code> data type values are dynamically available based on the condition of the system at the time of the command. These conditions are documented in brackets immediately following the list value and describe the run-time conditions necessary to set the field to the specific list value.</p> <p data-bbox="815 1413 1406 1482">For example, the following field description indicates availability conditions for both list values:</p> <pre data-bbox="815 1520 1406 1589">Name:Select Audio Measurement Tag:METER:Audio Meter</pre>

Field Property	Description
	<p>Commands:GET, SET</p> <p>Data Type:LIST</p> <p>List Values: SINAD/Ext Distortion [Test Mode<>P25 Trunk and Test Mode<>NXDN Trunk], Internal Distortion [Test Mode=Standard]</p> <p>Availability:</p> <p>Operating Mode:Monitor, Generate, Duplex</p> <p>Menu:METER:Subzone-e=SINAD/Distortion</p> <p>Typical Completion Time:100 ms</p> <p>The SINAD/Ext Distortion value is available in all test modes except trunking modes.</p> <p>The Internal Distortion is only available in Standard test mode.</p> <p>Do not include the condition when setting a value; the correct command for this example is: SET METER:Audio Meter=SINAD/Ext Distortion</p> <p>Range - Numeric values may have limited acceptable ranges. If the number has settable units (See Units), the range is always defined in the base units. If the data set into the field is outside the range, the R8200 will coerce the new value into the range at either the minimum or maximum value. The command will be accepted and respond with a prompt code of 1 (Ranged).</p> <p>Units - Some floating point values have settable units. If the field has settable units, this property will list the valid</p>

Field Property	Description
	<p>entries. To set a floating point value with its units, format the data as “value units”; for example:</p> <p>Command:</p> <pre>SET RF:Monitor Frequency=1.2 GHz</pre> <p>Reponse:</p> <p>0:1.20000000 GHz</p> <p>However, sending the units is not a requirement. If units are not sent, the system will apply the currently configured units to the data. For example, if the following two commands are sent, the second will be assumed to be in MHz.</p> <pre>SET RF:Monitor Frequency=403 MHz</pre> <p>0:403.000000 MHz</p> <pre>SET RF:Monitor Frequency=405</pre> <p>0:405.000000 MHz</p>
Availability	<p>Because the R8200 disables sub-systems to provide the most efficient use of processing, certain fields may not be available at all times. Fields that have availability requirements are denoted under this property.</p> <p>Synth Format - Field is only accessible when the specified Audio Format is selected. This availability requirement is unique to fields in the Audio Zone and used to configure specific audio formats such as PL, DPL, etc.</p> <p>Operating Mode - Field is only accessible when the ana-</p>

Field Property	Description
	<p>lyzer is in the mode(s) indicated. If this property is not present, the field is available in any/all modes unless otherwise unavailable.</p> <p>Options - Field is only accessible when the specified option has been purchased. If this property is not present, the field is standard. Contact to purchase new options for your analyzer.</p> <p>Menu - Field is only accessible when the menu system has the given condition active. This condition may specify a region or a region and a subzone (Region -> Subzone). Use the <code>GO</code> and <code>SET</code> commands to navigate to and/or select the appropriate region. If this property is not present, the field is available regardless of region.</p>
<p>Typical Completion Time</p>	<p>This property provides the typical processing time for the field in milliseconds. Most commands take very little time to complete; however some commands take more time to apply the desired condition to the system.</p> <p>This is particularly important when creating automated control software. The M&C is designed for immediate command response. However if the previous command has not had time to complete, there is no guarantee that data will be ready to retrieve following a change in configuration.</p> <p>For example, the following commands if sent without delay would most likely result in an inaccurate Input Level reading:</p> <pre>SET RF:Monitor Frequency=403 MHz</pre> <p>0:403.000000 MHz</p>

Field Property	Description
	GET MONITOR:Input Level
	2:-32.3
	The prompt will be returned with code 2 (Busy) if the previous command was not given enough time to complete its transaction.

Local/Remote Control

The R8200 will temporarily lock out local users when the unit is remotely controlled. When the analyzer is in lock-out, the Operating Mode indicator on the lower-left part of the screen will flash between the operating mode and **Remote**. To regain local control, press **Esc** from the front panel.

Custom Formats

Some fields use a custom formatting that is required for data entry. This section describes each format type.

Format symbols

The following table lists format symbols and their descriptions.

Symbol	Description
\$	Alphabetic characters only (A-Z)
#	Decimal digits only (0-9)
0	Hexadecimal characters only (0-9, A-F)
x	Any/all characters are valid
:	Location in string must be a colon
.	Location in string must be a period

Format templates

The following table lists format templates and their descriptions.

Template	Description
0x0000\$	<p>Hexadecimal format. This field is a string containing a hexadecimal value the length of the number of digits to the right of the 0x prefix. If the data is shorter than the format, add leading zeros to ensure the appropriate value is set.</p> <p>Examples:</p> <pre>Format=0x0000 Setting => 0A3F Format=0x00 Setting => 3F Format=0x00000000 Setting => 00000A3F</pre>
#.####	<p>Floating point format. This field contains a floating point number with the precision defined by the number of digits to the right of the decimal point.</p> <p>Examples:</p> <pre>Format=#.## Setting => 4.02 Format=#.##### Setting => 1.10031</pre>
(POCSAGCustom)	<p>Used for blank formatting and the POCSAG text messaging, no particular formatting required.</p>
(56Tone)	<p>Used specifically for the 5/6 Tone code formatting. The 5/6 tone must be formatted as #-#####c where <i>c</i> is either empty or <i>X</i> indicating the 6-tone. The valid character set for the digital format (#) is [0123456789R] where the <i>R</i> character indicates a repeat tone.</p>

Template	Description
	Examples:
	0-12345
	2-12R45
	0-12346X
x	Any/all characters are valid
:	Location in string must be a colon
.	Location in string must be a period

Field Descriptions

For a complete listing of specific properties for each field accessible through the M&C interface, see Section 11.0 on page 11 of 157 in the [Monitor & Control Programmer's Guide \(CG-1110\)](#).

To learn how to use AutoScript to configure the analyzer, see **"Using AutoScript" on the next page**.

For AutoScript soft key definitions, ranges, discrete and default values, and detailed notes, see **"AutoScript Soft Keys" on page 799**.

Using AutoScript

The AutoScript menu enables virtually hands-free measurement of critical LMR performance characteristics. To use the AutoScript feature, scripts must be created and imported to the unit. Script format follows the Monitor and Control (M&C) command format. Each line in the script must contain an M&C command and must conform to M&C syntax rules. For more information, see the [Monitor & Control Programmer's Guide \(CG-1110\)](#).

Scripts may be created or edited using a text editor such as Windows Notepad. Script file names must end in `.txt`. A script designed to detect and display a local FM radio station is shown below.

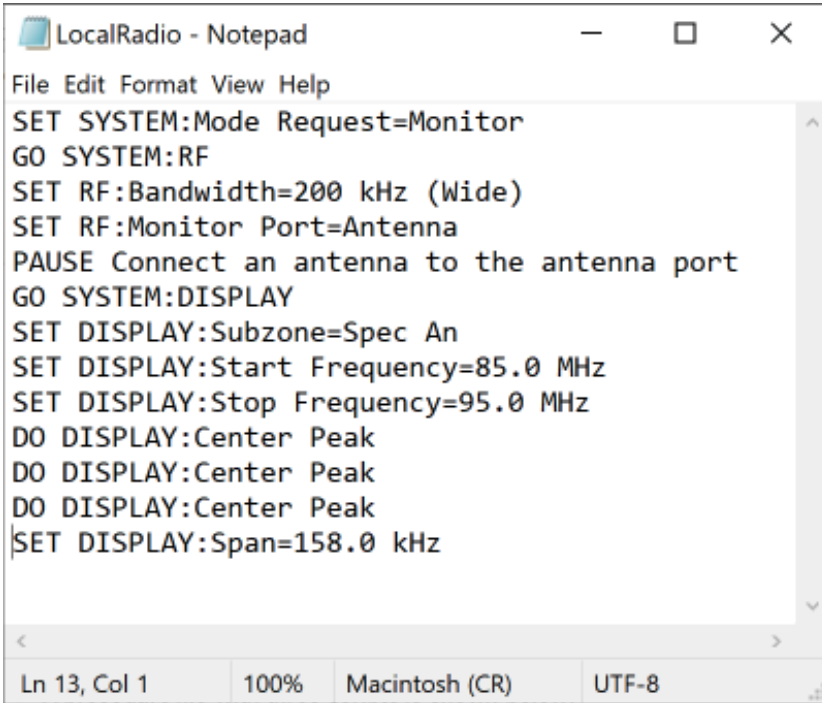

```
File Edit Format View Help
SET SYSTEM:Mode Request=Monitor
GO SYSTEM:RF
SET RF:Bandwidth=200 kHz (Wide)
SET RF:Monitor Port=Antenna
PAUSE Connect an antenna to the antenna port
GO SYSTEM:DISPLAY
SET DISPLAY:Subzone=Spec An
SET DISPLAY:Start Frequency=85.0 MHz
SET DISPLAY:Stop Frequency=95.0 MHz
DO DISPLAY:Center Peak
DO DISPLAY:Center Peak
DO DISPLAY:Center Peak
SET DISPLAY:Span=158.0 kHz
```

Ln 13, Col 1 100% Macintosh (CR) UTF-8

Example Script

```
SET SYSTEM:Mode Request=Monitor

GO SYSTEM:RF

SET RF:Bandwidth=200 kHz (Wide)
```

```
SET RF:Monitor Port=Antenna

PAUSE Connect an antenna to the antenna port

GO SYSTEM:DISPLAY

SET DISPLAY:Subzone=Spec An

SET DISPLAY:Start Frequency=85.0 MHz

SET DISPLAY:Stop Frequency=95.0 MHz

DO DISPLAY:Center Peak

DO DISPLAY:Center Peak

DO DISPLAY:Center Peak

SET DISPLAY:Span=158.0 kHz
```

Procedures are files defining multiple scripts to run in sequence. Procedure file names must end in *.prc*. A procedure file with three scripts is shown below.

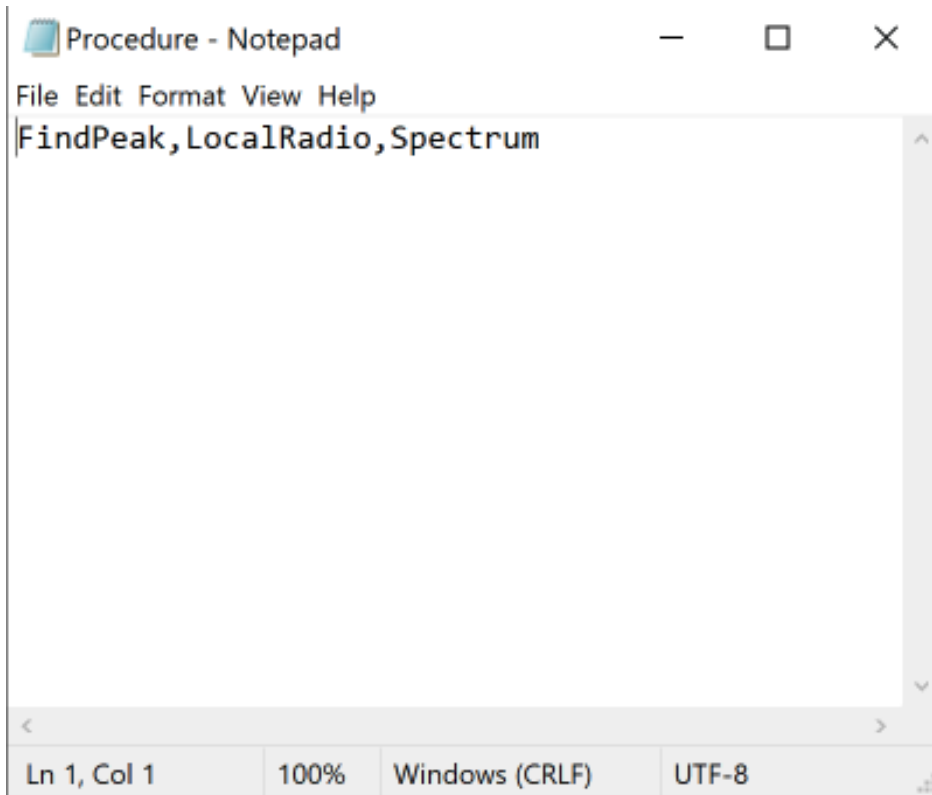

This example uses a script to detect and display a local radio station. To use AutoScript follow these steps.

Steps	Actions	Notes
1. Use Notepad to create the script <i>LocalRadio.txt</i> .	<ul style="list-style-type: none">a. Open Notepad.b. Copy the content from the Example Script section above into Notepad.c. Insert a USB drive into a USB port on the PC.d. Create a top-level folder on the USB drive named <i>FREEDOM</i> with a subfolder named <i>AutoScript</i>.e. Save the file to the thumb drive as <i><USB drive>:/FREEDOM/AutoScript/LocalRadio.txt</i>.	

Steps	Actions	Notes
	<ul style="list-style-type: none"> f. Eject the thumb drive from the PC and remove it from the PC's USB port. 	
<ul style="list-style-type: none"> 2. Access and load the <i>LocalRadio.txt</i> file on the USB drive. 	<ul style="list-style-type: none"> a. Insert the thumb drive into a USB port on the analyzer's side panel b. Press Test > AutoScript ... > Import Scripts. c. Select LocalRadio and press Enter. 	
<ul style="list-style-type: none"> 3. Execute the <i>LocalRadio</i> script. 	<ul style="list-style-type: none"> a. With LocalRadio highlighted, press Toggle Selection until a check appears in the check box to the left of the file name. b. Press Start AutoScript. 	<p>The analyzer completes the instructions and displays the FM radio signal.</p>

See **"AutoScript Soft Keys" on page 799** for detailed descriptions of the soft keys in this menu. Each soft key is defined, along with its range, discrete, default, and saved state values.

7 Using Remote Front Panel

An R8200 with Remote Front Panel (Option R8-Remote) enabled can be operated over a network via Ethernet connection using the Remote Front Panel client installed on a personal computer. This chapter contains step-by-step instructions for licensing, downloading and installing the software along with an overview of the user interface.

NOTE

For the command and response interface, see the R8000 Monitor & Control Programmer's Guide (FCT-1110).

"Introducing Remote Front Panel" on page 342 contains an overview of the application as well as the system requirements.

"Configuring the DHCP Server" on page 347 contains instructions on configuring the server so that it automatically address the R8200.

"Configuring the Analyzer Network Port" on page 348 explains how to configure the analyzer for remote operation.

Introducing Remote Front Panel

An R8200 with Remote Front Panel (option R8-Remote) enabled can be operated at distance via TCP/IP network using the Remote Front Panel application installed on a personal computer.

The Remote Front Panel application is a software emulation of the Freedom R8200 front panel user interface. The remote front panel includes all of the user interface features of the hardware with the exceptions of the microphone, speaker, volume knob, squelch LED, and line power switch, as shown.

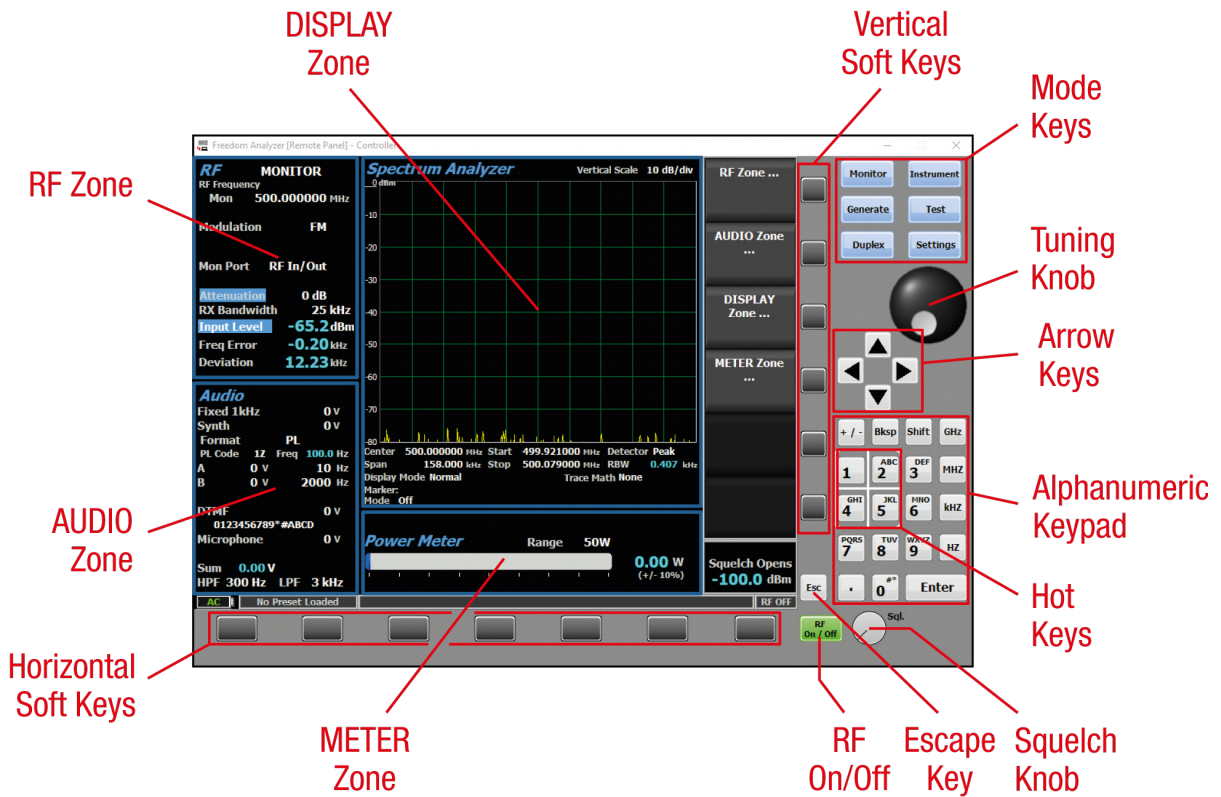

Ensure that your R8200 is running the latest firmware before enabling Option R8-Remote and installing the Remote Front Panel software on the Windows PC. For information on updating the instrument firmware, see <http://freedomcte.com/upgrades/>.

Remote Operation Requirements

The following equipment and personnel are required to install and configure the Remote Front Panel software:

- R8200 with AC power adapter and latest firmware.
- Windows 10 computer with network connectivity and Administrator privileges
- Ethernet 10/100Base-T network
- DHCP server (for operation over routed networks)
- Ethernet 10/100Base-T patch cable
- Network technician and/or administrator
- Network bandwidth $\geq 1.5\text{MB/s}$
- Display resolution $\geq 1024 \times 768$ pixels

Control

CAUTION

It is recommended that only one RFP client be used to access the R8200 in order to reduce the potential of losing control of the access license for the single point of control.

A single PC may view the R8200 display and control the interface with a computer mouse. Controlling the unit remotely does not prevent control locally and vice versa.

Remote Interface Limitations

- The graphical update rate is slower and depends on network latency.
- Calibration, which requires that RF connections be removed, is not supported.
- Updates, which require that a USB drive be inserted, are not supported.
- The following user-interface items are not supported: microphone, speaker, volume knob, squelch LED, and power button.

Enabling the Remote Front Panel

Option R8-Remote along with the Remote Front Panel installation package enable the use of the Remote Front Panel. If you ordered Option R8-Remote after receiving your R8200, you will receive a licensing document listing the 16-digit hexadecimal license code for Option R8-Remote. You will need this code to complete the following licensing procedure. To enable Option R8-Remote, complete the following steps.

Steps	Actions	Notes
1. Access the Options menu on the R8200.	a. Press Test > Presets > Load Factory Configuration .	This returns the analyzer to its factory default settings.
	b. Press Settings > Options .	This opens the Options table containing a complete list of all available System and AutoTune options for your R8200. A blue Enabled field highlights the active options. Inactive options are listed as Disabled.



2. Enable the R8-Remote option.	a. Press Enter Option Key .	This opens the 16-digit Enter Option Key dialog.
	b. Refer to the 16-digit hexadecimal	

Steps	Actions	Notes
	key for Option R8-Remote in the license document.	
c.	Enter the 16-digit hexadecimal key using the Enter Option Key dialog.	The R8200 displays a dialog confirming the option you are about to enable. To keep the option disabled, press Cancel . After pressing Continue , the option is enabled as shown.
d.	Verify your entry before pressing Enter .	
e.	To enable the option, press Continue .	



Installing the Remote Front Panel Software

To locate and install the Remote Front Panel installation package, complete the following steps.

Steps	Actions	Notes
1. Locate the RFP installation package.	<ul style="list-style-type: none">a. On the PC that will use the Remote Front Panel to access the R8200, open your browser.b. Browse to http://freedomcte.com/upgrades/.c. Click Remote Front Panel DOWNLOAD.d. Using Explorer, locate the ZIP file in your <i>/Downloads</i> folder and extract the compressed folder.e. Double-click the folder RemoteFPClient.Installer.1.1.0.0.	
2. Install the software.	<ul style="list-style-type: none">a. Double-click the file setup.exe.b. Follow the prompts to complete the software installation.	

Configuring the DHCP Server

There are three approaches to configuring a DHCP server for connecting the R8200 to the network. Obtain assistance from network technician or administrator. Common scenarios are:

- Fixed: The DHCP server assigns a fixed IP address for the specific physical address (MAC address) of the R8200. That IP address is always valid (e.g., 10.20.30.40). This is the recommended DHCP configuration.
- Leased: The DHCP server assigns the next available IP address to the R8200 for some duration (lease). The address is displayed by the R8200 on the Network Settings screen. The address may not be valid if the lease expires, or it may change if the unit reboots. Obtaining a new address from a remote location may be difficult, e.g., connecting to the DHCP server to obtain it.
- DNS: The DHCP server assigns an IP address to the R8200. The address is given a fixed name by DNS. That name is always valid even if the IP address changes. Instead of entering the IP address into the browser, the name may be entered (e.g., unit1.company.com).
- APIPA: No DHCP server is present. The R8200 supports Automatic Private IP Addressing (APIPA), appropriate for simple networks that have only one subnet. With APIPA, if no DHCP server is available, the R8200 automatically assigns itself a private IP address. If a DHCP server later becomes available, the R8200 changes its IP address to one obtained from the DHCP server. Using APIPA, the R8200 assigns itself an IP address from a range reserved for authorized private class B network addresses (169.254.0.1 through 169.254.255.254), with a subnet mask of 255.255.0.0; it does not assign a default gateway. See <http://technet.microsoft.com/enus/library/bb457118.aspx>.

Configuring the Analyzer Network Port

To configure the R8200 network port, complete the following steps.

Steps	Actions	Notes
1. Connect an Ethernet cable between your router and the R8200.	<ul style="list-style-type: none">a. Plug the Ethernet cable into an empty Ethernet connector on your router.b. Plug the opposite end of the Ethernet cable into the Ethernet port on the R8200.	
2. Enable Network Connections on the R8200.	<ul style="list-style-type: none">a. Activate the analyzer.b. Wait for the boot sequence to complete.c. Press Settings > Network Setup > Enable.	
3. Acknowledge the security alert.	<ul style="list-style-type: none">a. Review the security alert.b. Press Enter.	Observe the green indicator below the configuration data fields that reads Configuration In Progress . Wait several seconds for the configuration to complete. The analyzer remembers the previously set network settings.

CAUTION

When the network connection is enabled, the R8200 may be controlled by other computers on the network without restriction. It is strongly recommended that the R8200 be protected from unauthorized access through the use of external security measures.

NOTE

DHCP must be On. It is On by default when the Network Connection is enabled for the first time.

-
4. Ensure DHCP is active and enable if necessary. **a. Press DHCP.**

Steps	Actions	Notes
	<ul style="list-style-type: none"> b. Observe the DHCP operating state. c. If DHCP is On, continue to Step 5. d. If DHCP is Off, press On > Apply Network Changes. 	

CAUTION

When DHCP is used to configure the network interface, the R8200 may be controlled by computers on local or external networks.

5. Save the R8200 IP address.	<ul style="list-style-type: none"> a. Record the analyzer IP address. b. Store the information in a safe place. 	To disable the network connection, press Settings > Network Setup > Disable .
-------------------------------	---	--

Enabling Power-Loss Recovery

Following the loss of line service power, the R8200 is configured to remain off when power is restored. This is factory set functionality. If automatic reactivation of the R8200 is required after the loss of line power, the unit must be returned to the factory to be reconfigured for this operation.

Disabling Remote Access

Follow these steps to disable remote access to the analyzer.

Steps	Actions	Notes
1. Enable Network Connections on the R8200.	<ul style="list-style-type: none">a. Activate the analyzer.b. Wait for the boot sequence to complete.c. Press Settings > Network Setup > Enable.	
2. Acknowledge the security alert.	<ul style="list-style-type: none">a. Acknowledge the alert.b. Press Enter.	<p>Observe the green indicator below the configuration data fields that reads Configuration In Progress.</p> <p>Wait several seconds for the configuration to complete. The analyzer remembers the previously set network settings.</p>

Verification / Troubleshooting Information

The R8200 responds to ICMP ping. Default gateway connectivity questions are best resolved by confirming that both local and remote pings to the R8200 succeed.

The Remote Front Panel application communicates with the R8200 via TCP port 8000. If the network is protected by one or more firewalls, ensure that the network configuration does not block access to the R8200.

Network Configuration Failed (6002) message when applying network changes. The DHCP server may have responded late. The interface could be functional afterward.

Network Setup, APIPA IP Address is blank or zeros when the network connection is enabled. First, wait a minute. If the condition persists, then connect a live network cable to the Ethernet port, disable the network connection, restart the unit, and try again.

8 Monitor Mode Soft Keys

The Monitor Mode screen is divided into four functional Zones: RF, AUDIO, DISPLAY, and METER. This chapter contains detailed descriptions of the soft keys accessible in each Zone. Each soft key is defined, along with its range, discrete, default, and saved state values.

"RF Zone Soft Keys for Monitor Mode" on the next page includes the RF parameters associated with configuring the receiver.

"AUDIO Zone Soft Keys for Monitor Mode" on page 356 includes the parameters associated with demodulating the RF carrier.

"DISPLAY Zone Soft Keys for Monitor Mode" on page 383 includes the parameters associated with configuring your desired display.

"METER Zone Soft Keys for Monitor Mode" on page 401 includes the parameters associated with configuring general purpose and specialized instruments providing detailed analysis of the recovered baseband content from RF signals.

RF Zone Soft Keys for Monitor Mode

In Monitor Mode, the RF Zone contains the parameters for the receiver RF inputs. Use these soft keys to configure the R8200 receiver's center frequency, frequency span, start and stop frequency and which input you would like to analyze (RF In/Out or Antenna).

Monitor Frequency

Displays the Monitor Frequency dialog where you can enter the desired center frequency for the receiver.

Range	250 kHz to 3.0 GHz
Default	500 MHz
Saved State	Saved with instrument state

Copy Frequency to Generator

Sets the Generator output to the same frequency as the Monitor.

Range	250 kHz to 3.0 GHz
Default	500 MHz
Saved State	Saved with instrument state

Modulation Type

Activates a horizontal soft key menu where you can select the receiver's demodulation mode.

Discrete	FM, AM, USB, LSB
----------	------------------

Values	
Default	FM
Saved State	Saved with instrument state
Notes	You can choose between Frequency Modulation , Amplitude Modulation, Lower Side-Band Modulation, and Upper Side-Band Modulation. Output Level upper limits are reduced in AM to accommodate peak power levels.

Bandwidth

Activates a horizontal soft key menu where you can select the receiver's resolution (IF detection) bandwidth.

Discrete Values	6.25 kHz (Narrow), 8.33 kHz (Narrow), 10 kHz (Narrow), 12.5 kHz (Narrow), 25 kHz (Wide), 50 kHz (Wide), 100 kHz (Wide), 200 kHz (Wide)
Default	25 kHz (Wide)
Saved State	Saved with instrument state
Notes	For best measurement quality, always set an IF bandwidth no wider than necessary for the signal carrier of interest. For example, typical channel spacing for modern narrowband two-way radio is 12.5 kHz. Monitor IF bandwidths that are wider than needed for the channel spacing, allow more noise in the measurement, and degrade the quality of readings for deviation, frequency error, SINAD, etc.

Attenuation

Displays the Attenuation dialog where you can select the desired input port attenuation for the receiver.

Discrete	0 to 62 dB in 2 dB steps
----------	--------------------------

Values	
Default	0 dB
Saved State	Saved with instrument state
Notes	Attenuation selection can be overridden by AutoAttenuation located in Settings > System Settings > Automatic Attenuation. When Automatic Attenuation is On, the value is not settable as it will be reset by the power level entering the test equipment. If manual adjustment of attenuation is required (as when testing a TDMA signal), then make sure Automatic Attenuation is Off.

Pre-Amplifier

Displays the Pre-Amplifier dialog where you can enable a supplementary input amplifier that extends the sensitivity of the R8200 receiver by improving the S/N ratio for low signal levels.

Discrete Values	On, Off						
Default	Off						
Saved State	Saved with instrument state						
Notes	<p>AMP appears next to the Attenuation setting in the RF Zone whenever the Pre-Amplifier is active.</p> <p>By default, the pre-amplifier Auto-Off feature disables the pre-amplifier for best accuracy during broadband power (Watt Meter) measurements. When enabled, avoid input overload and erroneous signal strength readings by using the pre-amplifier only under the following conditions:</p> <table border="1"> <thead> <tr> <th>Monitor Port</th> <th>Maximum input level for using pre-amplifier</th> </tr> </thead> <tbody> <tr> <td>Antenna</td> <td>(Input signal in dBm – Attenuator setting) is equal or less than –40 dBm</td> </tr> <tr> <td>RF In/Out</td> <td>(Input signal in dBm – Attenuator setting) is equal or less than –10 dBm</td> </tr> </tbody> </table>	Monitor Port	Maximum input level for using pre-amplifier	Antenna	(Input signal in dBm – Attenuator setting) is equal or less than –40 dBm	RF In/Out	(Input signal in dBm – Attenuator setting) is equal or less than –10 dBm
Monitor Port	Maximum input level for using pre-amplifier						
Antenna	(Input signal in dBm – Attenuator setting) is equal or less than –40 dBm						
RF In/Out	(Input signal in dBm – Attenuator setting) is equal or less than –10 dBm						

Mon Port

Displays the Mon Port dialog where you can select the desired input port for the receiver.

Discrete Values	RF In/Out, Antenna
Default	RF In/Out
Saved State	Saved with instrument state
Notes	<p>If RF Level Offset is enabled, the Mon Port label is cyan-colored, indicating that receiver measurements are adjusted by the Mon Port-specific offset. Select an option using the arrow keys or tuning knob.</p> <p>CAUTION Do not apply input power to the Antenna input port.</p>

Input Source

Activates a horizontal soft key menu where you can select the receiver's input source.

Discrete Values	Auto, Input Level, Power Meter
Default	Auto
Saved State	Saved with instrument state
Notes	<p>When the RF input power on the RF In/Out port is above +20 dBm (100 mW), the analyzer utilizes a broadband power detector for the measurement. The Input Level field in the RF Zone changes to Power Meter to indicate this measurement mode. This disables TDMA from auto-switching between input sources during unused slots.</p>

Input Units

Activates a horizontal soft key menu where you can select the units of measure for the receiver's input source.

Discrete Values	Volts, Watts, dBm
Default	dBm
Saved State	Saved with instrument state

Freq Error Units

Activates a horizontal soft key menu where you can select the units of measure for the receiver's frequency error.

Discrete Values	Hertz, PPM
Default	Hertz
Saved State	Saved with instrument state

AUDIO Zone Soft Keys for Monitor Mode

In Monitor Mode, the audio synthesizers operate like a stand-alone audio generator since they are not modulating a carrier generated by the R8200. Use these soft keys to generate message content available at the Mod In/Out connector as a modulating stimulus for your device under test.

Fixed 1 kHz Level

Displays the Fixed 1 kHz Level dialog where you can enter the desired value for tone generator amplitude.

Range	0 to 8 V _p
Default	0 V
Saved State	Saved with instrument state

Fixed 1 kHz Mode

Activates a horizontal soft key menu where you can select the tone generator operating state.

Discrete Values	Off, Continuous
Default	Off
Saved State	Saved with instrument state
Notes	When the tone is activated, the Fixed 1 kHz field is highlighted in green.

Synth Level

Displays the Synth Level dialog where you can enter the amplitude for the synthesized audio generator.

Range	0 to 8 V _p
Default	0 V
Saved State	Saved with instrument state

Format

Activates a horizontal soft key menu where you can select the encoding format for the synthesized audio generator.

NOTE

This section describes the Monitor Mode AUDIO Zone soft keys in their factory default configuration order. Thus, the PL format soft key is listed below as the default encoding format for the synthesized audio generator in Monitor Mode. Soft keys for the other synthesized audio generator formats such as DPL, DPL Invert, A/B Sequence, 5/6 Tone, POCSAG, and General Sequence, as well as their unique submenu soft keys, begin with **"DPL and DPL Invert Synthesizer Formats Soft Keys"** on page 367.

Discrete Values	PL, DPL, DPL Invert, A/B Sequence, 5/6 Tone, POCSAG, General Sequence
Default	PL
Saved State	Saved with instrument state
Notes	In Monitor Mode, the audio synthesizers operate like a stand-alone audio generator since they are not modulating a carrier. Selecting a format instantiates the active encoding type for the audio synthesizer. This is an independent synthesizer for encoding audio stimulus such as PL, DPL, or A/B Sequence. The output of this encoded signal is available at the Mod In/Out port. See below for specific soft keys associated with each format.

Synth Mode

Activates a horizontal soft key menu where you can select the synthesized audio generator operating state.

Discrete Values	Off, Continuous
Default	Off
Saved State	Saved with instrument state

PL Code

When the audio synthesizer format is set to PL, pressing this soft key displays the PL Code dialog where you can enter codes for the Motorola Private-Line coded squelch signaling format. The following table lists valid codes and their frequencies.

Code	Frequency (Hz)	Code	Frequency (Hz)	Code	Frequency (Hz)	Code	Frequency (Hz)
XZ	67.0	ZB	97.0	4Z	136.5	7A	192.8
WZ	69.3	1Z	100.0	4A	141.3	M1	203.5
XA	71.9	1A	103.5	4B	146.2	8Z	206.5
WA	74.4	1B	107.2	5Z	151.4	M2	210.7
XB	77.0	2Z	110.9	5A	156.7	M3	218.1
WB	79.7	2A	114.8	5B	162.2	M4	225.7
YZ	82.5	2B	118.8	6Z	167.9	9Z	229.1
YA	85.4	3Z	123.0	6A	173.8	M5	233.6
YB	88.5	3A	127.3	6B	179.9	M6	241.8
ZZ	91.5	3B	131.8	7Z	192.8	M7	250.3
ZA	94.8						

PL Code Table

When the audio synthesizer format is set to PL, pressing this soft key displays the PL Code Table where you can enter codes for the Motorola Private-Line coded squelch signaling format.

Tone A Level

Pressing this soft key displays the Tone A Level dialog where you can enter the amplitude for the A Variable tone generator.

Range	0 to 8 V _p
Default	0 V
Saved State	Saved with instrument state
Notes	This is an independent generator used for encoded audio such as PL, DPL, A/B Sequence, etc.

Tone A Frequency

Pressing this soft key displays the Tone A Frequency dialog where you can enter the frequency for the A Variable tone generator.

Range	0 to 19999 Hz
Default	10 Hz
Saved State	Saved with instrument state

Tone A Mode

Pressing this soft key activates a horizontal soft key menu where you can select the operating mode for the A Variable tone generator.

Discrete Values	Off, Continuous, Burst
Default	Off
Saved State	Saved with instrument state

Tone B Level

Pressing this soft key displays the Tone B Level dialog where you can enter the amplitude for the B Variable tone generator.

Range	0 to 8 V _p
Default	0 V
Saved State	Saved with instrument state

Tone B Frequency

Pressing this soft key displays the Tone B Frequency dialog where you can enter the frequency for the B Variable tone generator.

Range	0 to 19999 Hz
Default	10 Hz
Saved State	Saved with instrument state

Tone B Mode

Pressing this soft key activates a horizontal soft key menu where you can select the operating mode for the B Variable tone generator.

Discrete Values	Off, Continuous, Burst
Default	Off
Saved State	Saved with instrument state

DTMF Level

Pressing this soft key displays the DTMF Level dialog where you can enter the amplitude for the Dual Tone Multi-Frequency tone generator.

Range	0 to 8 V _p
Default	0 V
Saved State	Saved with instrument state
Notes	DTMF is used for testing telephone-interfaced systems.

DTMF Mode

Pressing this soft key activates a horizontal soft key menu where you can select the operating mode for the Dual Tone Multi-Frequency tone generator.

Discrete Values	Off, Continuous, Burst
Default	Off
Saved State	Saved with instrument state
Notes	DTMF is used for testing telephone-interfaced systems.

DTMF Code

Pressing this soft key opens the DTMF Code dialog where you can enter a code sequence for the Dual Tone Multi-Frequency tone generator. Pressing this key also activates a horizontal soft key menu where you can insert a space in the code sequence or clear the present values from the cursor to the end.

Discrete Values	1, 2, 3, 4, 5, 6, 7, 8, 9, 0, *, #, A, B, C, D
Default	1234567890*#ABCD
Saved State	Saved with instrument state
Notes	DTMF is used for testing telephone-interfaced systems. The code may be entered by using the vertical arrow keys or tuning knob to highlight the desired field in the DTMF Code table. The alphanumeric keypad enables direct numeric entry. Alpha characters are entered by cycling through repeated presses of the appropriate numeric key.

DTMF Code Table

Pressing this soft key activates the DTMF Code Table providing additional control when generating a DTMF Code sequence. In addition to the DTMF Code data entry window, other selections permit adjustment of the Tone Duration and Inter-digit Delay. A Single Digit mode also allows single key press tone generation similar to a telephone keypad.

Tone Duration

Pressing this soft key opens the Tone Duration dialog where you can enter the code sequence duration for the Dual Tone Multi-Frequency tone generator.

Range	1 to 9999 ms
Default	100 ms
Saved State	Saved with instrument state
Notes	DTMF is used for testing telephone-interfaced systems.

Inter-Digit Delay

Pressing this soft key opens the Inter-Digit Delay dialog where you can enter the delay between individual digits broadcast by the code sequence from the Dual Tone Multi-Frequency tone generator.

Range	1 to 9999 ms
Default	100 ms
Saved State	Saved with instrument state
Notes	DTMF is used for testing telephone-interfaced systems.

Single Digit

Pressing this soft key activates a horizontal soft key menu where you can choose a single digit to broadcast as the code sequence from the Dual Tone Multi-Frequency tone generator.

Discrete Values	*, #, A, B, C, D
Default	*
Saved State	Saved with instrument state
Notes	DTMF is used for testing telephone-interfaced systems.

Microphone Level

Pressing this soft key activates a Microphone Level dialog where you can set the modulation level for the external microphone attached to the R8200.

Range	0 to 8 V
Default	0 V
Saved State	Saved with instrument state
Notes	The displayed units reflect the modulation mode chosen in the RF Zone, either <i>Deviation</i> in kHz for FM or <i>%AM</i> (percent modulation) for AM.

Microphone Mode

Pressing this soft key activates a horizontal soft key menu where you can enable or disable modulation from an external microphone attached to the Mic In port of the analyzer.

Discrete Values	Off, Continuous
Default	Off
Saved State	Saved with instrument state
Notes	Pressing the PTT button on the external microphone switches the analyzer into Generate Mode. Modulation from the microphone is applied to the carrier when the Microphone mode is set to Continuous.

High Pass Filter

Pressing this soft key activates a horizontal soft key menu where you can select the 3 dB high pass frequency for filtering the R8200 baseband response to recovered audio.

Discrete	1 Hz, 300 Hz, 3 kHz
----------	---------------------

Values	
Default	300 Hz
Saved State	Saved with instrument state
Notes	This setting is used in conjunction with the Low Pass Filter to determine the audio pass band for the R8200 baseband circuitry. For best audio and measurement quality, always set an audio pass band no wider than necessary for the signal of interest. For example, a typical two-way radio audio pass band is 300 Hz to 3 kHz. Pass bands wider than necessary allow more noise in the measurement and degrade the audio quality and the readings for deviation, frequency error, SINAD, etc. The default settings for the High and Low Pass filters are 300 Hz and 3 kHz respectively.

Low Pass Filter

Pressing this soft key activates a horizontal soft key menu where you can select an audio filter low pass frequency.

Discrete Values	300 Hz, 3 kHz, 20 kHz
Default	300 Hz
Saved State	Saved with instrument state
Notes	This setting is used in conjunction with the High Pass Filter to determine the audio pass band for the R8200 baseband circuitry. For best audio and measurement quality, always set an audio pass band no wider than necessary for the signal of interest. For example, a typical two-way radio pass band is 300 Hz to 3 kHz. Pass bands wider than necessary allow more noise in the measurement and degrade the audio quality and the readings for deviation, frequency error, SINAD, etc.

Voltage Units

Pressing this soft key activates a horizontal soft key menu where you can select the type of voltage units to be used in the AUDIO Zone Sum display.

Discrete Values	Volts (V), Millivolts (mV), Decibel Volts (dBV)
Default	Volts (V)
Saved State	Saved with instrument state

DPL and DPL Invert Synthesizer Formats Soft Keys

NOTE

The following sections describe the soft keys for the supplementary audio synthesizer formats: DPL, DPL Invert, A/B Sequence, 5/6 Tone, POCSAG, and General Sequence. For the default audio synthesizer format, see **"PL Code" on page 359**.

The following soft key is unique to the DPL and DPL Invert synthesizer formats.

DPL Code

When the audio synthesizer format is set to DPL or DPL Invert, pressing this soft key displays the DPL Code dialog where you can enter codes for the Motorola Digital-Private-Line coded squelch signaling format using the vertical arrow keys or the tuning knob.

Discrete Values	000, 001, 002, 003, 004, 005, 006, 007, 010, 011, 012, 013, 014, 015, 016, 017, 020, 021, 022, 023, 024, 025, 026, 027, 030, 031, 032, 033, 034, 035, 036, 037, 040, 041, 042, 043, 044, 045, 046, 047, 050, 051, 052, 053, 054, 055, 056, 057, 060, 061, 062, 063, 064, 065, 066, 067, 070, 071, 072, 073, 074, 075, 076, 077, 100, 101, 102, 103, 104, 105, 106, 107, 110, 111, 112, 113, 114, 115, 116, 117, 120, 121, 122, 123, 124, 125, 126, 127, 130, 131,
-----------------	---

	132, 133, 134, 135, 136, 137, 140, 141, 142, 143, 144, 145, 146, 147, 150, 151, 152, 153, 154, 155, 156, 157, 160, 161, 162, 163, 164, 165, 166, 167, 170, 171, 172, 173, 174, 175, 176, 177, 200, 201, 202, 203, 204, 205, 206, 207, 210, 211, 212, 213, 214, 215, 216, 217, 220, 221, 222, 223, 224, 225, 226, 227, 230, 231, 232, 233, 234, 235, 236, 237, 240, 241, 242, 243, 244, 245, 246, 247, 250, 251, 252, 253, 254, 255, 256, 257, 260, 261, 262, 263, 264, 265, 266, 267, 270, 271, 272, 273, 274, 275, 276, 277, 300, 301, 302, 303, 304, 305, 306, 307, 310, 311, 312, 313, 314, 315, 316, 317, 320, 321, 322, 323, 324, 325, 326, 327, 330, 331, 332, 333, 334, 335, 336, 337, 340, 341, 342, 343, 344, 345, 346, 347, 350, 351, 352, 353, 354, 355, 356, 357, 360, 361, 362, 363, 364, 365, 366, 367, 370, 371, 372, 373, 374, 375, 376, 377, 400, 401, 402, 403, 404, 405, 406, 407, 410, 411, 412, 413, 414, 415, 416, 417, 420, 421, 422, 423, 424, 425, 426, 427, 430, 431, 432, 433, 434, 435, 436, 437, 440, 441, 442, 443, 444, 445, 446, 447, 450, 451, 452, 453, 454, 455, 456, 457, 460, 461, 462, 463, 464, 465, 466, 467, 470, 471, 472, 473, 474, 475, 476, 477, 500, 501, 502, 503, 504, 505, 506, 507, 510, 511, 512, 513, 514, 515, 516, 517, 520, 521, 522, 523, 524, 525, 526, 527, 530, 531, 532, 533, 534, 535, 536, 537, 540, 541, 542, 543, 544, 545, 546, 547, 550, 551, 552, 553, 554, 555, 556, 557, 560, 561, 562, 563, 564, 565, 566, 567, 570, 571, 572, 573, 574, 575, 576, 577, 600, 601, 602, 603, 604, 605, 606, 607, 610, 611, 612, 613, 614, 615, 616, 617, 620, 621, 622, 623, 624, 625, 626, 627, 630, 631, 632, 633, 634, 635, 636, 637, 640, 641, 642, 643, 644, 645, 646, 647, 650, 651, 652, 653, 654, 655, 656, 657, 660, 661, 662, 663, 664, 665, 666, 667, 670, 671, 672, 673, 674, 675, 676, 677, 700, 701, 702, 703, 704, 705, 706, 707, 710, 711, 712, 713, 714, 715, 716, 717, 720, 721, 722, 723, 724, 725, 726, 727, 730, 731, 732, 733, 734, 735, 736, 737, 740, 741, 742, 743, 744, 745, 746, 747, 750, 751, 752, 753, 754, 755, 756, 757, 760, 761, 762, 763, 764, 765, 766, 767, 770, 771, 772, 773, 774, 775, 776, 777
Default	000
Saved State	Saved with instrument state

A/B Sequence Synthesizer Format Soft Keys

The following soft keys are unique to the A/B Sequence synthesizer format.

A/B Sequence

When the audio synthesizer format is set to A/B Sequence, pressing this soft key activates a horizontal soft key menu where you can select one of four timing sequences for the two-tone sequential paging format.

Discrete Values	1, 2, 3, 4
Default	1
Saved State	Saved with instrument state
Notes	Sequences 1 and 2 utilize fixed timing for standard Tone and Tone/Voice pagers, while Sequences 3 and 4 afford user-defined tone frequencies, durations, and delays.

A/B Sequence Table

When the audio synthesizer format is set to A/B Sequence, pressing this soft key activates a programming table for the two-tone sequential paging format. The A/B Sequence encoding mode uses the Tone A and Tone B generators and one of four selectable timing sequences determined by the Sequence soft key. Sequences 1 and 2 utilize fixed timing for standard tone and tone/voice pagers, while sequences 3 and 4 may be customized. When the vertical arrow keys highlight the programmable sequences 3 and 4, an additional submenu appears for defining tone frequencies, durations, and delays.

Sequence

When the audio synthesizer format is set to A/B Sequence, pressing this soft key activates a horizontal soft key menu where you can select one of four timing sequences for the two-tone sequential paging format.

Discrete Values	1, 2, 3, 4
-----------------	------------

Default	1
Saved State	Saved with instrument state
Notes	Sequences 1 and 2 utilize fixed timing for standard tone and tone/voice pagers, while Sequences 3 and 4 afford user-defined tone frequencies, durations, and delays.

Sequence (3 or 4) Tone A Duration

When the audio synthesizer format is set to A/B Sequence, pressing this soft key activates the Tone A Duration dialog where you can adjust the length of Tone A.

Range	0 to 9.99 s
Default	0 s
Saved State	Saved with instrument state
Notes	This function only applies to Sequence 3 and 4.

Sequence (3 or 4) Tone A Delay

When the audio synthesizer format is set to A/B Sequence, pressing this soft key activates the Tone A Delay dialog where you can adjust the delay for Tone A.

Range	0 to 9.99 s
Default	0 s
Saved State	Saved with instrument state
Notes	This function only applies to sequence 3 and 4

Sequence (3 or 4) Tone B Duration

When the audio synthesizer format is set to A/B Sequence, pressing this soft key activates the Tone B Duration dialog where you can adjust the length of Tone B.

Range	0 to 9.99 s
Default	0 s
Saved State	Saved with instrument state
Notes	This function only applies to sequence 3 and 4.

Sequence (3 or 4) Tone B Delay

When the audio synthesizer format is set to A/B Sequence, pressing this soft key activates the Tone B Delay dialog where you can adjust the delay for Tone B.

Range	0 to 9.99 s
Default	0 s
Saved State	Saved with instrument state
Notes	This function only applies to sequence 3 and 4.

5/6 Tone Synthesizer Format Soft Keys

The following soft keys are unique to the 5/6 Tone synthesizer format.

5/6 Tone

When the audio synthesizer format is set to 5/6 Tone, pressing this soft key activates a 5/6 Tone dialog, where you can enter a 5/6 tone sequence.

Discrete Values	0, 1, 2, 3, 4, 5, 6, 7, 8, 9, R, X
Default	R-12345X
Saved State	Saved with instrument state
Notes	The first digit preceding the hyphen is the preamble tone for activating one of ten battery-saver groups. The R-Repeat key or “R” tone is used in place of a repeated digit. After hearing the tone, the operator may assume that the prior digit is being transmitted again. If the digit is repeated a third time, the original tone is transmitted. A sixth or “X” tone is optional for pagers that support this function. The “X” tone indicates that a different beep pattern is used in place of that used for the standard 5 tone response. Pressing the 6-Tone soft key adds the “X” tone to the transmission.

POCSAG Synthesizer Format Soft Keys

The following soft keys are unique to the POCSAG synthesizer format.

POCSAG Message

When the audio synthesizer format is set to POCSAG, pressing this soft key activates a POCSAG Message dialog.

Discrete Values	Tone Only, NumericNum, NumericSet, AlphaNumUC, AlphaNumLC, AlphaNumSP, NumericCust, AlphaNumCust
Default	Tone Only
Saved State	Saved with instrument state
Notes	Highlighting the NumericCust or AlphaNumCust selections allows editing of the respective custom Numeric or Alpha-numeric strings. Up to 16 characters may be entered. Entered NumericCust and AlphaNumCust strings are truncated or expanded to match Message Length.

	<p>See "POCSAG Message Encoding Tables" below.</p> <p>Tone Only: <empty string></p> <p>NumericNum: 0123456789</p> <p>NumericSet: The used characters in the Numeric set.</p> <p>AlphaNumUC: ABCDEFGHIJKLMNOPQRSTUVWXYZ</p> <p>AlphaNumLC: abcdefghijklmnopqrstuvwxyz</p> <p>AlphaNumSP: space!"#\$%()'*, -./:;<=>?@[^_`{ }~</p> <p>NumericCust: Anything in the Numeric set.</p> <p>AlphaNumCust: Anything in the Alpha-numeric set.</p>
--	---

POCSAG Message Encoding Tables

POCSAG Numeric Character Set	
Binary	Character
0000	0
0001	1
0010	2
0011	3
0100	4
0101	5
0110	6
0111	7
1000	8
1001	9
1010	Spare (not available)
1011	U
1100	-
1110	[
1111]

POCSAG Alphanumeric Character Set (7-bit ASCII)								
Decimal	Binary	Character	Decimal	Binary	Character	Decimal	Binary	Character
20	0100000	SPACE	52	1000000	@	84	1100000	`
21	0100001	!	53	1000001	A	85	1100001	a
22	0100010	“	54	1000010	B	86	1100010	b
23	0100011	#	55	1000011	C	87	1100011	c
24	0100100	\$	56	1000100	D	88	1100100	d
25	0100101	%	57	1000101	E	89	1100101	e
26	0100110	&	58	1000110	F	90	1100110	f
27	0100111	‘	59	1000111	G	91	1100111	g
28	0101000	(60	1001000	H	92	1101000	h
29	0101001)	61	1001001	I	93	1101001	i
30	0101010	*	62	1001010	J	94	1101010	j
31	0101011	+	63	1001011	K	95	1101011	k
32	0101100	,	64	1001100	L	96	1101100	l
33	0101101	-	65	1001101	M	97	1101101	m
34	0101110	.	66	1001110	N	98	1101110	n
35	0101111	/	67	1001111	O	99	1101111	o
36	0110000	0	68	1010000	P	100	1110000	p
37	0110001	1	69	1010001	Q	101	1110001	q
38	0110010	2	70	1010010	R	102	1110010	r
39	0110011	3	71	1010011	S	103	1110011	s
40	0110100	4	72	1010100	T	104	1110100	t
41	0110101	5	73	1010101	U	105	1110101	u
42	0110110	6	74	1010110	V	106	1110110	v
43	0110111	7	75	1010111	W	107	1110111	w
44	0111000	8	76	1011000	X	108	1111000	x
45	0111001	9	77	1011001	Y	109	1111001	y
46	0111010	:	78	1011010	Z	110	1111010	z

POCSAG Alphanumeric Character Set (7-bit ASCII)								
Decimal	Binary	Character	Decimal	Binary	Character	Decimal	Binary	Character
47	0111011	;	79	1011011	[111	1111011	{
48	0111100	<	80	1011100	\	112	1111100	
49	0111101	=	81	1011101]	113	1111101	}
50	0111110	>	82	1011110	^	114	1111110	~
51	0111111	?	83	1011111	_	115	1111111	N/A

POCSAG Table

When the audio synthesizer format is set to POCSAG, pressing this soft key displays the POCSAG Table where you can enter codes for the Motorola Private-Line coded squelch signaling format.

Discrete Values	Tone Only, NumericNum, NumericSet, AlphaNumUC, AlphaNumLC, AlphaNumSP, NumericCust, AlphaNumCust
Default	Tone Only
Saved State	Saved with instrument state

Synth Mode

When the audio synthesizer format is set to POCSAG, pressing this soft key activates a horizontal soft key menu where you can select the synthesized audio generator operating state.

Discrete Values	Off, Continuous, Burst
Default	Off
Saved State	Saved with instrument state
Notes	This is an independent generator used for encoded audio such as PL, DPL, A/B Sequence, etc.

Capcode

When the audio synthesizer format is set to POCSAG, pressing this key activates the Capcode input dialog.

Range	0 to 2097151
Default	0
Saved State	Saved with instrument state

Function Bits

When the audio synthesizer format is set to POCSAG, pressing this soft key activates a horizontal soft key menu where you can select the function bits.

Discrete Values	00, 01 ,10, 11
Default	00
Saved State	Saved with instrument state

Message Length

When the audio synthesizer format is set to POCSAG, pressing this key activates the Message Length input dialog.

Range	0 to 60
Default	16
Saved State	Saved with instrument state

Data Rate

When the audio synthesizer format is set to POCSAG, pressing this key activates the Data Rate input dialog.

Range	400 to 4800
Default	1200
Saved State	Saved with instrument state

Polarity

When the audio synthesizer format is set to POCSAG, pressing this soft key activates a horizontal soft key menu where you can select the POCSAG datastream polarity.

Discrete Values	Normal, Inverted
Default	Normal
Saved State	Saved with instrument state
Notes	When set to Normal, a logic high (1) results in a more positive frequency deviation in FM mode. A logic low (0) results in a more negative frequency deviation in FM mode. When set to Inverted, a logic high (1) results in more negative frequency deviation in FM mode. A logic low (0) results in a more positive frequency deviation in FM mode.

Error Bit

When the audio synthesizer format is set to POCSAG, pressing this key activates the Error Bit input dialog.

Range	0 to 2200
Default	1200
Saved State	Saved with instrument state
Notes	The error bit allows targeted insertion of an error into the page to test a POCSAG decoder's error correction capability. The setting toggles the Error Bit in the POCSAG page bit stream, where the bit stream uses a 1-based index. If Error Bit is set to 0 (default), no bits are toggled. If Error Bit is set ≥ 1 , then bit stream (Error Bit) is toggled.

General Sequence Synthesizer Format Soft Keys

The following soft keys are unique to the General Sequence synthesizer format.

Code Sequence

When the audio synthesizer format is set to General Sequence, pressing this key activates the Code Sequence input dialog where you can define a custom code sequence.

Discrete Values	0, 1, 2, 3, 4, 5, 6, 7, 8, 9, A, B, C, D, E, F, G, H, I, J
Default	0123456789ABCDEFGHIJ
Saved State	Saved with instrument state

General Sequence Table

When the audio synthesizer format is set to General Sequence, pressing this soft key displays the General Sequence Table where you can enter custom codes for use in sequences.

Notes	The table is populated with 20 Tone Codes (0 to 9 and A to J) with preset data for frequency, duration, and post-tone delay. The selected Tone Standard determines the preset data for each tone code. Regardless of the standard selected, each Tone Code can be edited for the current operating session or saved as a customized sequence.
-------	---

Select Tone Standard

When the audio synthesizer format is set to General Sequence, pressing this key activates the Tone Standard input dialog where you can select from a list of Tone Standards to use in sequencing.

Discrete Values	None, CCIR1, CCIR2, PCCIR, CCITT, EEA, EIA, Euro, NATEL, MODAT, ZVEI1, ZVEI2, ZVEI3, DZVEI, PDZVEI
Default	None
Saved State	Saved with instrument state

Synth Mode

When the audio synthesizer format is set to General Sequence, pressing this soft key activates a horizontal soft key menu where you can select the synthesized audio generator operating state.

Discrete Values	Off, Continuous, Burst
Default	Off
Saved State	Saved with instrument state
Notes	The status of the Synth Mode is shown in the Mode field.

Tone Frequency

When the audio synthesizer format is set to General Sequence, pressing this soft key activates a Tone Frequency input dialog where you can enter a frequency value for the highlighted code.

Range	0 to 20000 Hz
Default	0 Hz
Saved State	Saved with instrument state

Tone Duration

When the audio synthesizer format is set to General Sequence, pressing this soft key activates a Tone duration dialog where you can enter a duration for a highlighted code.

Range	0 to 0.5 s
Default	0 s
Saved State	Saved with instrument state

Post-Tone Delay

When the audio synthesizer format is set to General Sequence, pressing this soft key activates a Post-Tone Delay dialog, where you can enter the duration of the delay following the transmitted tone.

Range	0 to 1 s
Default	0.5 s
Saved State	Saved with instrument state

Save Sequence Definition

When the audio synthesizer format is set to General Sequence, pressing this soft key activates a Save Sequence Definition dialog, where you can enter an alphanumeric sequence name.

Range	A to Z and 0 to 9
Default	MY
Saved State	Saved with instrument state

Load Sequence Definition

When the audio synthesizer format is set to General Sequence, pressing this soft key activates a Load Sequence Definition dialog, where you can load a sequence.

Export Sequence Definition

When the audio synthesizer format is set to General Sequence, pressing this soft key activates an Export Sequence Definition dialog, where you can select a sequence definition to save on an external USB device.

Delete Sequence Definition

When the audio synthesizer format is set to General Sequence, pressing this soft key activates a Delete Sequence Definition dialog, where you can delete a sequence.

Sync to Code Entry

When the audio synthesizer format is set to General Sequence, pressing this soft key activates a Sync to Code Entry dialog, where you can select General Sequence sync setting.

Discrete Values	No, Yes
-----------------	---------

Default	Yes
Saved State	Saved with instrument state
Notes	<p>Yes – Any Tone Code alphanumeric value entered into the Code Sequence field is initially populated into the associated position in the Duration and Delay Sequence fields. This matches the frequency, duration, and delay values for each tone in the Code Sequence to that shown on the Tone Code line entry in the table. If desired, these initially synchronized Duration and Delay sequence entries can be changed to other values from the table.</p> <p>No – The entries for the Duration and Delay Sequences are set independently of the Code Sequence, with duration and delay values from any Tone Code on the table.</p>

Duration Sequence

When the audio synthesizer format is set to General Sequence, pressing this soft key activates a Duration Sequence dialog, where you can enter a custom duration sequence. Pressing this soft key also activates a horizontal soft key menu where you can clear a Duration Sequence entry.

Discrete Values	0, 1, 2, 3, 4, 5, 6, 7, 8, 9, A, B, C, D, E, F, G, H, I, J
Default	0123456789ABCDEFGHIJ
Saved State	Saved with instrument state
Notes	<p>Clear to End – clears the highlighted entry and all others to the right.</p> <p>Each entry in the Duration Sequence is paired in positional order with the associated entry in the Code Sequence, which provides the tone frequency, and the Delay Sequence, which provides the post tone delay. A duration of zero is used for Code Sequence entries that do not have an associated Duration Sequence entry. Duration Sequence entries that do not have an associated Code Sequence entry are ignored.</p>

Delay Sequence

When the audio synthesizer format is set to General Sequence, pressing this soft key activates a Delay Sequence dialog, where you can enter a custom delay sequence. Pressing this soft key also activates a horizontal soft key menu where you can clear a Delay Sequence entry.

Discrete Values	0, 1, 2, 3, 4, 5, 6, 7, 8, 9, A, B, C, D, E, F, G, H, I, J
Default	0123456789ABCDEFGHIJ
Saved State	Saved with instrument state
Notes	<p>Clear to End – clears the highlighted entry and all others to the right.</p> <p>Each entry in the Delay Sequence is paired in positional order with the associated entry in the Code Sequence, which provides the tone frequency, and the Duration Sequence, which provides the tone duration. A delay of zero is used for Code Sequence entries that do not have an associated Delay Sequence entry. Delay Sequence entries that do not have an associated Code Sequence entry are ignored.</p>

DISPLAY Zone Soft Keys for Monitor Mode

In Monitor Mode, the DISPLAY Zone represents the controls for the primary graticule measurement display or bar graphs. Use these soft keys to configure your desired display.

Select Display (DISPLAY Zone Menu)

Pressing this soft key activates a horizontal soft key menu where you can select the display mode.

Discrete Values	Spec An, Mod Scope, Oscilloscope, Bar Graphs
Default	Spec An
Saved State	Saved with instrument state

Center Frequency (Spectrum Analyzer submenu)

When display is set to Spec An, pressing this soft key displays the Center Frequency dialog where you can enter the desired value to set the center frequency on the receiver display.

Range	250 kHz to 3.0 GHz
Default	500 MHz
Saved State	Saved with instrument state

Span (Spectrum Analyzer submenu)

When display is set to Spec An, pressing this soft key displays the Span dialog where you can input the desired frequency span for the receiver.

Range	10 kHz to 20 MHz
Default	10 MHz
Saved State	Saved with instrument state
Notes	<p>Frequency span allows you to zoom in or out (change the span of the X-axis) on a signal of interest, while maintaining the relative power (Y-axis). To zoom in on a signal, decrease the frequency span while maintaining the signal at center frequency. To zoom out, increase the frequency span. The value entered for Span is automatically split between each side of the current center frequency.</p> <p>Receiver modulated audio is inhibited at spans above 158 kHz. Switch display to Mod Scope or use Demod at Marker function to hear audio at wider spans.</p>

Start Frequency (Spectrum Analyzer submenu)

When display is set to Spec An, pressing this soft key displays the Start Frequency dialog where you can input the lowest frequency currently measured and shown on the receiver display.

Range	250 kHz to 1.5 GHz
Default	495 MHz
Saved State	Saved with instrument state
Notes	The analyzer automatically centers the frequency display midway between Start and Stop frequencies.
Couplings	When adjusting the start frequency the stop frequency is held constant, meaning that both the center frequency and span will change.

Stop Frequency (Spectrum Analyzer submenu)

When display is set to Spec An, pressing this soft key displays the Stop Frequency dialog where you can input the highest frequency currently measured and shown on the receiver display.

Range	260 kHz to 3 GHz
Default	1 MHz
Saved State	Saved with instrument state
Notes	The analyzer automatically centers the frequency display midway between Start and Stop frequencies.
Couplings	When adjusting the stop frequency the start frequency is held constant, meaning that both the center frequency and span will change.

Reference Level (Spectrum Analyzer submenu)

When display is set to Spec An, pressing this soft key displays the Reference Level dialog where you can input the value of the top graticule line.

Range	0 to 90 dBm
Default	0 dBm
Saved State	Saved with instrument state

Vertical Scale (Spectrum Analyzer submenu)

When the display is set to Spec An, pressing this soft key activates a horizontal soft key menu where you can select the Y-axis scale.

Discrete Values	10 dB/div, 5 dB/div, 2 dB/div, 1 dB/div
Default	10 dB/div
Saved State	Saved with instrument state

Display Mode (Spectrum Analyzer submenu)

When the display is set to Spec An, pressing this soft key activates a horizontal soft key menu where you can select the trace graphing mode.

Discrete Values	Normal, Freeze, Max Hold, Average
-----------------	-----------------------------------

Default	Normal
Saved State	Saved with instrument state
Notes	<p>Normal – The display updates continuously.</p> <p>Freeze – The display provides a snapshot of the current display indication and stops additional updates. In Freeze Mode, the R8200 reacquires data and updates the display whenever Center Marker or Center Peak is pressed.</p> <p>Max Hold – The display retains the highest peak signal amplitudes measured during successive sweeps.</p> <p>Average – The displayed signal amplitudes are a rolling average of the peak amplitudes measured on each successive sweep. The average consists of one to five sweeps, shown beside the mode indication.</p>

Trace Math (Spectrum Analyzer submenu)

When the display is set to Spec An, pressing this soft key activates a horizontal soft key menu where you can select the trace math to be applied.

Discrete Values	None, Spec-Ref (log), ISpec-Ref (lin), Spec+Ref (lin)
Default	None
Saved State	Saved with instrument state
Notes	<p>The underlying units of the result are no longer dBm but dB for the displayed spectrum and thus marker power.</p> <p>None – This selection hides the reference trace and displays the spectrum resulting from the Display Mode unmodified.</p>

	<p>Spec-Ref (log) – This selection displays the difference of the Display Mode spectrum in dBm minus the reference trace in dBm, which normalizes the spectrum to 0 on the Y-axis. Subsequently, spectrum power is shown on the display and measured by absolute markers relative to the reference trace, i.e., correctly interpreted as dBm above the reference.</p> <p>ISpec-Refl (lin) – This choice displays the logarithm of the absolute value of the difference of the Display Mode spectrum in volts² minus the reference trace in volts². Although the absolute value of the difference avoids logarithm of negatives, it has the side effect of increasing the apparent noise power.</p> <p>Spec+Ref (lin) – This choice displays the logarithm of the sum of the Display Mode spectrum in volts² plus the reference trace in volts².</p>
--	---

Set Reference Trace (Spectrum Analyzer submenu)

When the display is set to Spec An, pressing this soft key saves the current trace as a separate blue reference trace.

Notes	<p>The trace is copied from what is currently shown, which is after any Display Mode processing as well as Trace Math computations. Therefore, ensure that both of those settings are appropriately set (i.e., Trace Math is None); setting the reference when Trace Math is active may yield incoherent results. Setting Display Mode to Average minimizes effects of a low level / high variance signal such as the noise floor. This static trace is used for computations when a Trace Math equation is specified and may simply be viewed even when one is not. It can be hidden by selecting Trace Math None.</p> <p>System changes that may invalidate the reference trace include port, amplification, attenuation, frequency, span, temperature, and calibration.</p>
-------	--

Detector (Spectrum Analyzer submenu)

When the display is set to Spec An, pressing this soft key activates a horizontal soft key menu where you can select the Detector mode.

Discrete Values	Power, Peak, Sample, Mean, Valley
Default	Peak
Saved State	Saved with instrument state

3 dB Marker (Spectrum Analyzer submenu)

When the display is set to Spec An, pressing this soft key activates a horizontal soft key menu where you can select the 3 dB Marker mode.

Discrete Values	Off, Frequency, Delta
Default	Off
Saved State	Saved with instrument state
Notes	<p>Off – Deactivates markers.</p> <p>Frequency – This selection places a marker above and below center frequency where the signal is –3 dB below the peak amplitude measured at center frequency. The upper and lower frequencies are shown on the display.</p> <p>Delta – This selection places a marker above and below center frequency where the signal is –3 dB below the peak amplitude measured at center frequency. The difference between these two frequencies is shown on the display.</p>

Marker Mode (Spectrum Analyzer submenu)

When the display is set to Spec An, pressing this soft key activates a horizontal soft key menu where you can select the Marker type and operating state.

Discrete Values	Off, Absolute, Delta
Default	Off
Saved State	Saved with instrument state
Notes	<p>Off – Deactivates markers.</p> <p>Absolute – This selection displays the frequency and absolute signal amplitude for each marker selected.</p> <p>Delta – This selection displays the frequency and amplitude difference between each pair of markers selected.</p> <p>Depending on the installed options, up to four markers can be enabled and selected for positioning while in Instrument Mode.</p>

Toggle Marker (Spectrum Analyzer submenu)

When the display is set to Spec An, pressing this soft key cycles through the available markers to activate one for repositioning. Active markers are yellow.

Center Marker (Spectrum Analyzer submenu)

When the display is set to Spec An, pressing this soft key moves the active marker to the middle of the spectrum.

Find Peak (Spectrum Analyzer submenu)

When the display is set to Spec An, pressing this soft key moves the active marker to highest trace peak.

Center Peak (Spectrum Analyzer submenu)

When the display is set to Spec An, pressing this soft key centers the display around the highest peak.

Demod at Marker (Spectrum Analyzer submenu)

When the display is set to Spec An and Marker Mode is set to absolute, pressing this soft key activates a horizontal soft key menu where you can select the demodulation mode at the active marker.

Discrete Values	Off, Single, Continuous
Default	Off
Saved State	Saved with instrument state
Notes	<p>Off – Deactivates markers.</p> <p>Single – Provides a one-time demodulation of the carrier signal located at the marker position for a quick listen at the marker frequency. Moving the marker or changing the monitor frequency, mode, or DISPLAY Zone selection switches the Demod At Marker function Off.</p> <p>Continuous – Continuous Mode allows users to move the selected marker to demodulate carriers across the entire displayed spectrum. On full-screen instruments, the user can setup several markers on various peaks and use the marker selection to quickly demodulate and listen to those peaks. Additionally, on the Dual Display, the user can simultaneously view the Modulation Scope while tuning the marker positions.</p> <p>To ensure audio is demodulated, the marker must be close enough to overlap the analyzer Monitor Bandwidth around the carrier frequency. Large Span settings increase marker frequency step size, limiting how close the marker can get to the actual frequency. To minimize step size, use the narrowest span practical when displaying multiple carriers.</p>

Vertical Scale (Modulation Scope submenu)

When display is set to Mod Scope, pressing this soft key activates a horizontal soft key menu where you can select the vertical scale-per-division.

Discrete Values	100, 200, 500 Hz and 1, 2, 5, 10, 20, 50 kHz
Default	1 kHz
Saved State	Saved with instrument state

Horizontal Scale (Modulation Scope submenu)

When display is set to Mod Scope, pressing this softkey displays the Horizontal Scale input dialog where you can select the horizontal scale.

Discrete Values	20, 50, 100, 200, 500 μ s and 1, 2, 5, 10, 20, 50, 100, 200, 500 ms and 1 s
Default	20 ms
Saved State	Saved with instrument state

Marker Mode (Modulation Scope submenu)

When display is set to Mod Scope, pressing this soft key activates a horizontal soft key menu where you can select the Marker type and operating state.

Discrete Values	Off, Delta V, Delta T, 1/Delta T
Default	Off
Saved State	Saved with instrument state
Notes	Off – Deactivates markers.

	<p>Delta V – The numeric reading shows the difference in amplitude between marker positions.</p> <p>Delta T – The numeric reading shows the difference in time between marker positions.</p> <p>1/Delta T – The numeric reading shows the inverse of the time difference between markers, which can be used to determine the frequency of a repetitive waveform.</p> <p>Depending on the installed options, up to four markers can be enabled and selected for positioning while in Instrument Mode.</p>
--	--

Toggle Marker (Modulation Scope submenu)

When the display is set to Mod Scope, pressing this soft key cycles through the available markers to activate one for repositioning. Active markers are yellow.

Trigger Mode (Modulation Scope submenu)

When display is set to Mod Scope, pressing this soft key activates a horizontal soft key menu where you can select the Modulation Scope Trigger type.

Discrete Values	Auto, Normal, Single
Default	Auto
Saved State	Saved with instrument state
Notes	<p>Auto – If a signal satisfying the Trigger Edge and Trigger Level settings is present, the display will sweep as in Normal Mode. If no signal satisfying the Trigger Edge and Trigger Level settings is present, then the display sweeps continuously until a signal satisfying the settings is acquired.</p> <p>Normal – The display sweeps only when the input signal satisfies the Trigger Edge and Trigger Level settings.</p> <p>Single – The display sweeps once after a key press is performed on the Single soft key if the signal satisfies the Trigger Edge and Trigger level settings.</p>

Trigger Level (Modulation Scope submenu)

When display is set to Mod Scope, pressing this soft key activates a Trigger Level dialog where you can enter the trigger threshold level in kHz.

Range	-200 to 200 kHz
Default	0 kHz
Saved State	Saved with instrument state

Trigger Edge (Modulation Scope submenu)

When display is set to Mod Scope, pressing this soft key activates a horizontal soft key menu where you can select the Modulation Scope trigger type.

Discrete Values	Rising, Falling, Either
Default	Rising
Saved State	Saved with instrument state

Vertical Position (Modulation Scope submenu)

When display is set to Mod Scope, pressing this soft key activates a horizontal soft key menu where you can adjust the Modulation Scope vertical position up or down.

Discrete Values	Move Down, Move Up
Default	Move Down
Saved State	Saved with instrument state

Coupling (Oscilloscope submenu)

When display is set to Oscilloscope, pressing this soft key activates a Coupling dialog menu where you can select the input voltage coupling.

Discrete Values	DC, AC
Default	DC
Saved State	Saved with instrument state

Horizontal Scale (Oscilloscope submenu)

When display is set to Oscilloscope, pressing this softkey displays the Horizontal Scale input dialog where you can select the horizontal scale.

Discrete Values	20, 50, 100, 200, 500 μ s and 1, 2, 5, 10, 20, 50, 100, 200, 500 ms and 1 s						
Default	1 ms						
Saved State	Saved with instrument state						
Notes	Digital Oscilloscopes are susceptible to aliasing, which can cause inaccurate signal reconstruction. The Maximum recommended input frequency for each horizontal scale setting is shown in the display area. For best results, follow the guidelines shown in the table below. <table border="1" data-bbox="402 1371 1393 1497"><thead><tr><th>Horizontal Scale</th><th>Max Signal Frequency</th><th>Max Recommended Signal Frequency</th></tr></thead><tbody><tr><td>20 μs</td><td>50000 Hz</td><td>50000 Hz</td></tr></tbody></table>	Horizontal Scale	Max Signal Frequency	Max Recommended Signal Frequency	20 μ s	50000 Hz	50000 Hz
Horizontal Scale	Max Signal Frequency	Max Recommended Signal Frequency					
20 μ s	50000 Hz	50000 Hz					

	Horizontal Scale	Max Signal Frequency	Max Recommended Signal Frequency
	50 μ s	50000 Hz	20000 Hz
	100 μ s	50000 Hz	10000 Hz
	200 μ s	25000 Hz	5000 Hz
	500 μ s	10000 Hz	2000 Hz
	1 ms	5000 Hz	1000 Hz
	2 ms	2500 Hz	500 Hz
	5 ms	1000 Hz	200 Hz
	10 ms	500 Hz	100 Hz
	20 ms	250 Hz	50 Hz
	50 ms	100 Hz	20 Hz
	100 ms	50 Hz	10 Hz
	200 ms	25 Hz	5 Hz
	500 ms	10 Hz	2 Hz
	1 s	5 Hz	1 Hz

Vertical Scale (Oscilloscope submenu)

When display is set to Oscilloscope, pressing this softkey displays the Vertical Scale input dialog where you can select the vertical scale.

Discrete Values	50, 100, 200, 500 mV and 1, 2, 5, 10, 15, 20, 25 V
Default	1 V
Saved State	Saved with instrument state

Marker Mode (Oscilloscope submenu)

When display is set to Oscilloscope, pressing this soft key activates a horizontal soft key menu where you can select the Marker type and operating state.

Discrete Values	Off, Delta V, Delta T, 1/Delta T
Default	Off
Saved State	Saved with instrument state
Notes	Off – Deactivates markers. Delta V – The numeric reading shows the difference in amplitude between marker positions. Delta T – The numeric reading shows the difference in time between marker positions. 1/Delta T – The numeric reading shows the inverse of the time difference between markers, which can be used to determine the frequency of a repetitive waveform. Depending on the installed options, up to four markers can be enabled and selected for positioning while in Instrument Mode.

Toggle Marker (Oscilloscope submenu)

When the display is set to Oscilloscope, pressing this soft key switches between Marker 1 and 2.

Trigger Mode (Oscilloscope submenu)

When display is set to Oscilloscope, pressing this soft key activates a horizontal soft key menu where you can select the Oscilloscope Trigger Mode.

Discrete	Auto, Normal, Single
----------	----------------------

Values	
Default	Auto
Saved State	Saved with instrument state
Notes	<p>Auto – If a signal satisfying the Trigger Edge and Trigger Level settings is present, the display will sweep as in Normal Mode. If no signal satisfying the Trigger Edge and Trigger Level settings is present, then the display sweeps continuously until a signal satisfying the settings is acquired.</p> <p>Normal – The display sweeps only when the input signal satisfies the Trigger Edge and Trigger Level settings.</p> <p>Single – The display sweeps once after a key press is performed on the Single soft key if the signal satisfies the Trigger Edge and Trigger level settings.</p>

Trigger Level (Oscilloscope submenu)

When display is set to Oscilloscope, pressing this soft key activates a Trigger Level dialog where you can enter the trigger threshold level.

Range	–100 to 100
Default	0
Saved State	Saved with instrument state

Trigger Position (Oscilloscope submenu)

When display is set to Oscilloscope, pressing this soft key activates a Trigger Level dialog where you can enter the trigger threshold level.

Discrete Values	10%, 50%, 90%
Default	50%
Saved State	Saved with instrument state

Trigger Edge (Oscilloscope submenu)

When display is set to Oscilloscope, pressing this soft key activates a horizontal soft key menu where you can select the Oscilloscope trigger type.

Discrete Values	Rising, Falling, Either
Default	Rising
Saved State	Saved with instrument state

Vertical Position (Oscilloscope submenu)

When display is set to Oscilloscope, pressing this soft key activates a horizontal soft key menu where you can adjust the Oscilloscope up or down.

Discrete Values	Move Down, Move Up
Default	Move Down
Saved State	Saved with instrument state

Set DC Offset (Oscilloscope submenu)

When display is set to Oscilloscope, pressing this soft key zeroes out the Oscilloscope to account for a DC offset.

Notes	With the Meter In port disconnected, press the soft key to eliminate the offset. The compensation is stored permanently in the analyzer until the next time this soft key is pressed.
-------	---

Deviation Average (Bar Graphs submenu)

When display is set to Bar Graphs, pressing this soft key activates a horizontal soft key menu where select Deviation Average settings to process the response settings.

Discrete Values	Normal, Peak Average, Pwr-Weight Average, RMS Average, +/-Peak/2
Default	Normal
Saved State	Saved with instrument state
Notes	<p>Normal – No smoothing is engaged, which provides the quickest measurement response.</p> <p>Peak Average – The deviation peaks are averaged over a time window, which smooths the reading but slows the response.</p> <p>Pwr-Weight Average – The deviation measurement is processed with an RMS converter, but the display calibration remains in peak units (i.e., a deviation of 3 kHz pk will read 3 kHz on the numeric readout and bar graph). This type of processing significantly reduces the effect of narrow deviation spikes and noise while providing a speed of response similar to the normal mode.</p> <p>Scale calibration and the peak readings are only valid for single tone repetitive sine wave modulation. For the RMS value of any modulation waveform, divide the displayed peak reading by 1.414.</p>

	<p>RMS Average – The deviation measurement is the square root of the mean of the squares of the deviation values. This type of processing significantly reduces the effect of narrow deviation spikes and noise while providing a speed of response similar to the normal mode.</p> <p>Scale calibration and the RMS readings are valid for any wave modulation (e.g., sawtooth).</p>
--	---

METER Zone Soft Keys for Monitor Mode

In Monitor Mode, the METER Zone displays the controls for configuring supplementary metering devices. Use these soft keys to apply general purpose and specialized instruments providing detailed analysis of the recovered baseband content from RF signals.

Select Meter (METER Zone menu)

Activates a horizontal soft key menu where you can select the metering device.

Discrete Values	Power Meter, Voltmeter, SINAD/Distortion, Decoder, Frequency Counter, RF Scan, SNRMeter
Default	Power Meter
Saved State	Saved with instrument state
Notes	RF Scan is not available in Generate Mode.

Power Meter (METER Zone menu)

Opens the Power Meter display and submenu.

Range (Power Meter submenu)

When the meter is set to Power Meter, pressing this soft key activates a horizontal soft key menu where you can select the power meter range.

Discrete Values	5, 10, 50, 150 W
Default	50 W
Saved State	Saved with instrument state
Notes	For best accuracy, disable the Pre-amplifier in Monitor Mode and set the Gen Port in Generate Mode to RF In/Out.

Voltmeter (METER Zone menu)

Opens the Voltmeter display and submenu.

Select Voltmeter Mode (Voltmeter submenu)

When the meter is set to Voltmeter, pressing this soft key activates a horizontal soft key menu where you can select the voltage mode for the Voltmeter.

Discrete Values	AC Volts, DC Volts
Default	AC Volts
Saved State	Saved with instrument state
Notes	AC Volts measures AC voltage applied to the Meter In port. The dBm computation assumes an impedance of 600Ω.

Coupling (Voltmeter submenu)

When the meter is set to Voltmeter, pressing this soft key activates a Coupling dialog menu where you can select the input voltage coupling.

Discrete Values	DC, AC
Default	DC
Saved State	Saved with instrument state

AC Range (Voltmeter submenu)

When the meter is set to Voltmeter, pressing this soft key activates a horizontal soft key menu where you can select the power meter AC voltage range.

Discrete Values	Auto, 1, 10, 70 V
Default	Auto
Saved State	Saved with instrument state
Notes	The range on AC and DC must be 1 or 10 Volts to use 600 Ohm Input Impedance.

Set dBr Reference (Voltmeter submenu)

When the meter is set to Voltmeter and Voltmeter mode is set to AC, pressing this soft key sets a reference input voltage.

Notes	When selected, dBm measurements are frozen, and a dBr indicator appears. The dBr indicates the normalized measurement between the reference input voltage and the current input voltage.
-------	--

Clear dBr Reference (Voltmeter submenu)

When the meter is set to Voltmeter and Voltmeter mode is set to AC, pressing this soft key clears the dBr reference input voltage.

Voltage Units (Voltmeter submenu)

When the meter is set to Voltmeter, pressing this soft key activates a horizontal soft key menu where you can select the power meter range.

Discrete Values	Volts (V), Millivolts (mV), Decibel Volts (dBV)
Default	Volts (V)
Saved State	Saved with instrument state

DC Range (Voltmeter submenu)

When the meter is set to Voltmeter, pressing this soft key activates a horizontal soft key menu where you can select the power meter DC voltage range.

Discrete Values	Auto, 1, 10, 70 V
Default	Auto
Saved State	Saved with instrument state
Notes	The range on AC and DC must be 1 or 10 Volts to use 600 Ohm Input Impedance.

SINAD/Distortion (METER Zone menu)

Opens the SINAD/Distortion display and submenu.

Select Audio Measurement (SINAD/Distortion submenu)

When the meter is set to SINAD/Ext Distortion, pressing this soft key activates a horizontal soft key menu where you can select the distortion source.

Discrete Values	SINAD/Ext Distortion, Internal Distortion
Default	SINAD/Ext Distortion
Saved State	Saved with instrument state

Decoder (METER Zone menu)

Opens the Decoder display and submenu.

Select Decoder Type (Decoder submenu)

When the meter is set to Decoder, pressing this soft key activates a horizontal soft key menu where you can select the decoder type.

Discrete Values	PL/Period Counter, DPL Decode, DTMF Decode, 2-Tone Decode, 5/6 Tone Decode, General Sequence
Default	PL/Period Counter
Saved State	Saved with instrument state

Reset (Decoder submenu)

When the meter is set to Decoder and Decoder Type is set to DTMF Decode, pressing this soft key resets the decoder.

Decode (Decoder submenu)

When the meter is set to Decoder, pressing this soft key activates a horizontal soft key menu where you can select start and stop the decoding.

Discrete Values	Stop, Start
Default	Stop
Saved State	Saved with instrument state
Notes	This function is available one for the 2-Tone Decode, 5/6 Tone Decode, General Sequence decoder types.

Decode to Standard (Decoder submenu)

When the meter is set to Decoder, pressing this soft key activates a horizontal soft key menu where you can select the decoding standard to be used.

Discrete Values	None, CCIR1, CCIR2, PCCIR, CCITT, EEA, EIA, Euro, NATEL, MODAT, ZVEI1, ZVEI2, ZVEI3, PZVEI, DZVEI, PDZVEI
Default	None
Saved State	Saved with instrument state
Notes	This function is available one for the General Sequence decoder type.

Low Pass Filter (Decoder submenu)

When the meter is set to Decoder, pressing this soft key activates a horizontal soft key menu where you can select the high pass frequency.

Discrete Values	300 Hz, 3 kHz, 20 kHz
Default	300 Hz
Saved State	Saved with instrument state

High Pass Filter (Decoder submenu)

When the meter is set to Decoder, pressing this soft key activates a horizontal soft key menu where you can select the high pass frequency.

Discrete Values	1 Hz, 300 Hz, 3 kHz
Default	1 Hz
Saved State	Saved with instrument state

Input Decoding (Decoder submenu)

When the meter is set to Decoder, pressing this soft key displays a Input Decoding dialog menu where you can select which decoding source to use.

Discrete Values	Internal, External
Default	Internal
Saved State	Saved with instrument state

Frequency Counter (METER Zone menu)

Opens the Frequency Counter display and submenu.

Reset (Frequency Counter submenu)

When the meter is set to Frequency Counter, pressing this soft key resets the frequency counter.

Input Decoding (Frequency Counter submenu)

When the meter is set to Frequency Counter, pressing this soft key displays a Input Decoding dialog menu where you can select which decoding source to use.

Discrete Values	Internal, External
Default	Internal
Saved State	Saved with instrument state

Resolution (Frequency Counter submenu)

When the meter is set to Frequency Counter, pressing this soft key activates a horizontal soft key menu where you can select the frequency counter resolution.

Discrete Values	0.001 Hz, 0.01 Hz, 0.1 Hz, 1.0 Hz, 10 Hz
Default	1.0 Hz
Saved State	Saved with instrument state

RF Scan (METER Zone menu)

Opens the RF Scan display and submenu.

Start Frequency (RF Scan submenu)

When the meter is set to RF Scan, pressing this key displays the Start Frequency dialog where you can input the start frequency to be used in the RF scan.

Range	1 to 2991 MHz
Default	400 MHz
Saved State	Saved with instrument state

Stop Frequency (RF Scan submenu)

When the meter is set to RF Scan, pressing this key displays the Stop Frequency dialog where you can input the start frequency to be used in the RF scan.

Range	1 to 2991 MHz
Default	600 MHz
Saved State	Saved with instrument state

Scan (RF Scan submenu)

When the meter is set to RF Scan, pressing this soft key activates a horizontal soft key menu where you can select the scanning mode.

Discrete Values	Off, Single, Auto
Default	Off

Saved State	Saved with instrument state
Notes	<p>Off – Deactivates scanning.</p> <p>Single – Sweep the span defined by the Start and Stop Frequency parameters once.</p> <p>Auto – Continuously sweeps the span defined by the Start and Stop Frequency parameters.</p> <p>The signal captured by the scan will automatically set the Monitor Frequency to the closest channel in the selected RF Bandwidth. For example, if the signal captured by the receiver in a 12.5 kHz BW is 390.011911 kHz, then the Monitor Frequency will be set to 390.0125 (i.e., the ideal channel frequency). This ensures that the Frequency Error meter will display the offset from this ideal.</p>

SNR (METER Zone menu)

Opens the Signal-to-Noise Ratio display.

9 Generate Mode Soft Keys

The Generate Mode screen is divided into four functional Zones: RF, AUDIO, DISPLAY, and METER. This chapter contains detailed descriptions of the soft keys accessible in each Zone. Each soft key is defined, along with its range, discrete, default, and saved state values.

"RF Zone Soft Keys for Generate Mode" on the next page includes the RF parameters associated with configuring the transmitter.

"AUDIO Zone Soft Keys for Generate Mode" on page 414 includes the parameters associated with modulating the RF carrier.

"DISPLAY Zone Soft Keys for Generate Mode" on page 442 includes the parameters associated with configuring your desired display.

"METER Zone Soft Keys for Generate Mode" on page 451 includes the parameters associated with configuring general purpose and specialized instruments providing detailed analysis of the recovered baseband content from RF signals.

RF Zone Soft Keys for Generate Mode

In Generate Mode, the RF Zone contains the controls for the transmitter RF outputs. Use these soft keys to configure your transmitter including generate frequency, modulation type, output level and the output you wish to broadcast on (RF In/Out or RF Gen Out).

Generate Frequency

Displays the Generate Frequency dialog where you can enter the desired value to set the center frequency on the transmitter display.

Range	250 kHz to 3.0 GHz
Default	500 MHz
Saved State	Saved with instrument state

Copy Frequency to Monitor

Sets the analyzer Monitor to the same frequency as the Generator.

Modulation Type

Activates a horizontal soft key menu where you can select the transmitter modulation mode.

Discrete Values	FM, AM, USB, LSB
Default	FM
Saved State	Saved with instrument state
Notes	Output Level upper limits are reduced in AM to accommodate peak power levels.

Output Level

Displays the Output Level dialog, where you can enter the desired output power level.

Range	RF Gen Out port: –95 dBm to 5 dBm RF In/Out port: –130 dBm to –30 dBm
Default	–50 dBm
Saved State	Saved with instrument state
Notes	When Modulation Type is AM, the upper limits are –1 dBm and –36 dBm respectively. If the R8_Gen_Ext Option is enabled, then the RF Gen Port range is –125 dBm to +5 dBm.

Gen Port

Displays the Gen Port dialog where you can select the desired output port for the transmitter.

Discrete Values	RF In/Out, Gen Out
Default	RF In/Out
Saved State	Saved with instrument state
Notes	If RF Level Offset is enabled, the Gen Port label is cyan-colored, indicating that Output Level amplitudes are adjusted by the Gen Port-specific offset.

Output Units

Activates a horizontal soft key menu where you can select the units for the transmitter output source.

Discrete Values	dBm, Volts, mV, μ V, Watts, mW, μ W
Default	dBm
Saved State	Saved with instrument state
Notes	The level is displayed in the Output Level field in the RF Zone display window.

AUDIO Zone Soft Keys for Generate Mode

In Generate Mode, the AUDIO Zone displays the controls for modulating the RF carrier. Use these soft keys to configure the transmitted message.

Mod Port Mode

Displays the Mod Port Mode dialog menu where you can set the directionality of the Mod Port.

Discrete Values	In, Out
Default	Out
Saved State	Saved with instrument state
Notes	Remove voltage sources before selecting Out. If input voltage is detected at the port, the Out selection is ignored, and an alert is displayed at the bottom of the display.

Fixed 1 kHz Level

Displays the Fixed 1 kHz Level dialog where you can enter the desired value for the tone generator amplitude.

Range	0 to 12.5 kHz
Default	0 kHz
Saved State	Saved with instrument state

Fixed 1 kHz Mode

Activates a horizontal soft key menu where you can select the tone generator operating state.

Discrete Values	Off, Continuous
Default	Off
Saved State	Saved with instrument state
Notes	When the tone is activated, the Fixed 1kHz field is highlighted in green.

Synth Level

Displays the Synth Level dialog where you can enter the amplitude for the synthesized audio generator.

Range	0 to 12.5 kHz
Default	0 kHz
Saved State	Saved with instrument state
Notes	This is an independent generator used for encoded audio such as PL, DPL, A/B Sequence, etc.

Format

Activates a horizontal soft key menu where you can select the encoding format for the synthesized audio generator.

NOTE

This section describes the Generate Mode AUDIO Zone soft keys in their factory default configuration order. Thus, the PL format soft key is listed below as the default encoding format for the synthesized audio generator in Generate Mode. Soft keys for the other synthesized audio generator formats such as DPL, DPL Invert, A/B Sequence, 5/6 Tone, POCSAG, and General Sequence, as well as their unique submenu soft keys, begin with **"DPL and DPL Invert Synthesizer Formats Soft Key"** on page 426.

Discrete Values	PL, DPL, DPL Invert, A/B Sequence, 5/6 Tone, POCSAG, General Sequence
Default	PL
Saved State	Saved with instrument state
Notes	Selecting a format instantiates the active encoding type for the audio synthesizer. This is an independent synthesizer for encoding audio stimulus such as PL, DPL, or A/B Sequence. This encoded signal is available at the Mod In/Out port.

Synth Mode

Activates a horizontal soft key menu where you can select the synthesized audio generator operating state.

Discrete Values	Off, Continuous
Default	Off
Saved State	Saved with instrument state

PL Code

When the audio synthesizer format is set to PL, pressing this soft key displays the PL Code dialog where you can enter codes for the Motorola Private-Line coded squelch signaling format. The following table lists valid codes and their frequencies.

Code	Frequency (Hz)	Code	Frequency (Hz)	Code	Frequency (Hz)	Code	Frequency (Hz)
XZ	67.0	ZB	97.0	4Z	136.5	7A	192.8
WZ	69.3	1Z	100.0	4A	141.3	M1	203.5
XA	71.9	1A	103.5	4B	146.2	8Z	206.5
WA	74.4	1B	107.2	5Z	151.4	M2	210.7
XB	77.0	2Z	110.9	5A	156.7	M3	218.1
WB	79.7	2A	114.8	5B	162.2	M4	225.7
YZ	82.5	2B	118.8	6Z	167.9	9Z	229.1
YA	85.4	3Z	123.0	6A	173.8	M5	233.6
YB	88.5	3A	127.3	6B	179.9	M6	241.8
ZZ	91.5	3B	131.8	7Z	192.8	M7	250.3
ZA	94.8						

PL Code Table

When the audio synthesizer format is set to PL, pressing this soft key displays the PL Code Table where you can enter codes for the Motorola Private-Line coded squelch signaling format. The following table lists valid codes and their frequencies.

Code	Frequency (Hz)	Code	Frequency (Hz)	Code	Frequency (Hz)	Code	Frequency (Hz)
XZ	67.0	ZB	97.0	4Z	136.5	7A	192.8

WZ	69.3	1Z	100.0	4A	141.3	M1	203.5
XA	71.9	1A	103.5	4B	146.2	8Z	206.5
WA	74.4	1B	107.2	5Z	151.4	M2	210.7
XB	77.0	2Z	110.9	5A	156.7	M3	218.1
WB	79.7	2A	114.8	5B	162.2	M4	225.7
YZ	82.5	2B	118.8	6Z	167.9	9Z	229.1
YA	85.4	3Z	123.0	6A	173.8	M5	233.6
YB	88.5	3A	127.3	6B	179.9	M6	241.8
ZZ	91.5	3B	131.8	7Z	192.8	M7	250.3
ZA	94.8						

Tone A Level

Displays the Tone A Level dialog where you can enter the amplitude for the A Variable tone generator.

Range	0 to 12.5 kHz
Default	0 kHz
Saved State	Saved with instrument state
Notes	When modulation type is set to AM, Tone A Level utilizes units of %.

Tone A Frequency

Displays the Tone A Frequency dialog where you can enter the frequency for the A Variable tone generator.

Range	0 to 20000 Hz
Default	10 Hz
Saved State	Saved with instrument state

Tone A Mode

Displays a horizontal soft key menu where you can select the operating mode for the A Variable tone generator.

Discrete Values	Off, Continuous, Burst
Default	Off
Saved State	Saved with instrument state

Tone B Level

Displays the Tone B Level dialog where you can enter the amplitude for the B Variable tone generator.

Range	0 to 12.5 kHz
Default	0 kHz
Saved State	Saved with instrument state
Notes	When modulation type is set to AM, Tone B Level utilizes units of %.

Tone B Frequency

Displays the Tone B Frequency dialog where you can enter the frequency for the B Variable tone generator.

Range	0 to 20000 Hz
Default	2000 Hz
Saved State	Saved with instrument state

Tone B Mode

Displays a horizontal soft key menu where you can select the operating mode for the B Variable tone generator.

Discrete Values	Off, Continuous, Burst
Default	Off
Saved State	Saved with instrument state

Tone C Level

Displays the Tone B Level dialog where you can enter the amplitude for the C Variable tone generator.

Range	0 to 12.5 kHz
Default	0 kHz
Saved State	Saved with instrument state
Notes	When modulation type is set to AM, Tone C Level utilizes units of %.

Tone C Frequency

Displays the Tone B Frequency dialog where you can enter the frequency for the C Variable tone generator.

Range	0 to 100000 Hz
Default	30000 Hz
Saved State	Saved with instrument state

Tone C Mode

Displays a horizontal soft key menu where you can select the operating mode for the C Variable tone generator.

Discrete Values	Off, Continuous, Burst
Default	Off
Saved State	Saved with instrument state
Notes	Tone C is only available in Generate and Duplex mode. Tone C ONLY outputs on RF signal and is NOT available on Mod Out port.

DTMF Level

Activates the DTMF Level dialog where you can enter the amplitude for the Dual Tone Multi-Frequency tone generator.

Range	0 to 12.5 kHz
Default	0 kHz
Saved State	Saved with instrument state
Notes	When modulation type is set to AM, DTMF Level utilizes units of %.

DTMF Mode

Activates a horizontal soft key menu where you can select the operating mode for the Dual Tone Multi-Frequency tone generator.

Discrete Values	Off, Continuous, Burst
Default	Off
Saved State	Saved with instrument state

DTMF Code

Displays the DTMF Code dialog where you can enter a code sequence for the Dual Tone Multi-Frequency tone generator. Pressing this key also activates a horizontal soft key menu where you can insert a space in the code sequence or clear the present values from the cursor to the end.

Discrete Values	0, 1, 2, 3, 4, 5, 6, 7, 8, 9, 0, *, #, A, B, C, D
Default	01234567890*#ABCD
Saved State	Saved with instrument state
Notes	Pressing the alphanumeric keypad allows direct numeric entry, and alpha characters are entered by cycling through repeated presses of the appropriate numeric key.

DTMF Table

Displays soft keys and the DTMF Table that provides more control when generating a DTMF Code sequence.

Tone Duration

Displays the Tone Duration dialog where you can enter the code sequence duration for the Dual Tone Multi-Frequency tone generator.

Range	40 to 9999 ms
Default	100 ms
Saved State	Saved with instrument state

Inter-Digit Delay

Displays the Inter-Digit Delay dialog where you can enter the delay between individual digits broadcast by the code sequence for the Dual Tone Multi-Frequency tone generator.

Range	20 to 9999 ms
Default	70 ms
Saved State	Saved with instrument state

Single Digit

Displays a horizontal soft key menu where you can choose a single digit to broadcast as the code sequence for the Dual Tone Multi-Frequency tone generator.

Discrete Values	*, #, A, B, C, D, 0 to 9
Default	*
Saved State	Saved with instrument state
Notes	Pressing the alphanumeric keypad allows direct numeric entry.

Microphone Level

Displays a Microphone Level dialog where you can enter the level in kHz.

Range	0 to 12.5 kHz
Default	0 kHz
Saved State	Saved with instrument state
Notes	When modulation type is set to AM, Microphone Level utilizes units of %.

Microphone Mode

Displays a horizontal soft key menu where you can enable or disable modulation from an external microphone attached to the Mic In port of the analyzer.

Discrete Values	Off, Continuous
Default	Off
Saved State	Saved with instrument state
Notes	Pressing the PTT button on the external microphone switches the analyzer into Generate Mode. Modulation from the microphone is applied to the carrier when the mode is set to Continuous.

Mod In Port Level

Displays the Mod In Port Level dialog where you can enter the level in kHz.

Range	0 to 12.5 kHz
Default	0 kHz
Saved State	Saved with instrument state
Notes	The audio signals must equal $\pm 1 V_{pk}$ to provide a reference for accurate display of the applied modulation level. When modulation type is set to AM, Mod In Port Level utilizes units of %.

Mod In Port Mode

Displays a horizontal soft key menu where you can select the Mod In Port operating state.

Discrete Values	Off, Continuous
Default	Off
Saved State	Saved with instrument state
Notes	Remove voltage sources before selecting Out. If input voltage is detected at the port, the Out selection is ignored, and an alert is displayed at the bottom of the display.

High Pass Filter

Displays a horizontal soft key menu where you can select an audio filter high pass frequency.

Discrete Values	1 Hz, 300 Hz, 3 kHz
Default	300 Hz

Saved State	Saved with instrument state
Notes	For best audio and measurement quality, always set an audio pass band no wider than necessary for the signal of interest. Example: A typical two-way radio pass band is 300 Hz to 3 kHz. Pass bands wider than necessary allow more noise in the measurement and degrade the audio quality and the readings for deviation, frequency error, SINAD, etc.

Low Pass Filter

Displays a horizontal soft key menu where you can select an audio filter low pass frequency.

Discrete Values	300 Hz, 3 kHz, 20 kHz
Default	300 Hz
Saved State	Saved with instrument state
Notes	For best audio and measurement quality, always set an audio pass band no wider than necessary for the signal of interest. Example: A typical two-way radio pass band is 300 Hz to 3 kHz. Pass bands wider than necessary allow more noise in the measurement and degrade the audio quality and the readings for deviation, frequency error, SINAD, etc.

DPL and DPL Invert Synthesizer Formats Soft Key

NOTE

The following sections describe the soft keys for the supplementary audio synthesizer formats: DPL, DPL Invert, A/B Sequence, 5/6 Tone, POCSAG, and General Sequence. For the default audio synthesizer format, see ["PL Code" on page 417](#).

The following soft key is unique to the DPL and DPL Invert audio synthesizer format.

DPL Code

When the audio synthesizer format is set to DPL or DPL Invert, pressing this soft key displays the DPL Code dialog where you can enter codes for the Motorola Digital-Private-Line coded squelch signaling format.

Range	000 to 777
Default	000
Saved State	Saved with instrument state

A/B Sequence Synthesizer Format Soft Keys

The following soft keys are unique to the A/B Sequence audio synthesizer format.

A/B Sequence Code

When the audio synthesizer format is set to A/B Sequence, pressing this soft key activates a horizontal soft key menu where you can select one of four timing sequences for the two-tone sequential paging format.

Discrete Values	1, 2, 3, 4
Default	1
Saved State	Saved with instrument state
Notes	Sequences 1 and 2 utilize fixed timing for standard "tone" and "tone/voice" pagers, while sequences 3 and 4 may be customized through numeric entries by the user.

A/B Sequence Table

When the audio synthesizer format is set to A/B Sequence, pressing this soft key activates soft keys and the A/B Sequence Table that provides more control when generating an A/B Code sequence.

Sequence

When the audio synthesizer format is set to A/B Sequence, pressing this soft key activates a horizontal soft key menu where you can select one of four timing sequences for the two-tone sequential paging format.

Discrete Values	1, 2, 3, 4
Default	1
Saved State	Saved with instrument state
Notes	Sequences 1 and 2 utilize fixed timing for standard "tone" and "tone/voice" pagers, while sequences 3 and 4 may be customized through numeric entries by the user.

Sequence 3/4 Tone A Duration

When the audio synthesizer format is set to A/B Sequence, pressing this soft key activates a Tone A duration dialog.

Range	0 to 9.99 s
Default	0 s
Saved State	Saved with instrument state
Notes	This function only applies to sequence 3 and 4, with 3/4 being 3 or 4 depending on the selected channel.

Sequence 3/4 Tone A Delay

When the audio synthesizer format is set to A/B Sequence, pressing this soft key activates a Tone A delay dialog.

Range	0 to 9.99 s
Default	0 s
Saved State	Saved with instrument state
Notes	This function only applies to sequence 3 and 4, with 3/4 being 3 or 4 depending on the selected channel.

Sequence 3/4 Tone B Duration

When the audio synthesizer format is set to A/B Sequence, pressing this soft key activates the Tone B duration dialog.

Range	0 to 9.99 s
Default	0 s
Saved State	Saved with instrument state
Notes	This function only applies to sequence 3 and 4, with 3/4 being 3 or 4 depending on the selected channel.

Sequence 3/4 Tone B Delay

When the audio synthesizer format is set to A/B Sequence, pressing this soft key activates the Tone B delay dialog.

Range	0 to 9.99 s
-------	-------------

Default	0 s
Saved State	Saved with instrument state
Notes	This function only applies to sequence 3 and 4, with 3/4 being 3 or 4 depending on the selected channel.

5/6 Tone Synthesizer Format Soft Keys

The following soft keys are unique to the 5/6 Tone audio synthesizer format.

5/6 Tone

When the audio synthesizer format is set to 5/6 Tone, pressing this soft key activates a horizontal submenu and 5/6 Tone dialog, where you can enter a 5/6 tone sequence.

Discrete Values	0, 1, 2, 3, 4, 5, 6, 7, 8, 9, R, X
Default	R-12345X
Saved State	Saved with instrument state
Notes	The first digit preceding the hyphen is the preamble tone for activating one of ten battery-saver groups. The R-Repeat key or “R” tone is used in place of a repeated digit. After hearing the tone, the operator may assume that the prior digit is being transmitted again. If the digit is repeated a third time, the original tone is transmitted. A sixth or “X” tone is optional for pagers that support this function. The “X” tone indicates that a different beep pattern is used in place of that used for the standard 5 tone response. Pressing the 6-Tone soft key adds the “X” tone to the transmission.

POCSAG Synthesizer Format Soft Keys

The following soft keys are unique to the POCSAG audio synthesizer format.

POCSAG Table

When the audio synthesizer format is set to POCSAG, pressing this soft key displays the POCSAG Table where you can enter codes for the Motorola Private-Line coded squelch signaling format.

Discrete Values	Tone Only, NumericNum, NumericSet, AlphaNumUC, AlphaNumLC, AlphaNumSP, NumericCust, AlphaNumCust
Default	Tone Only
Saved State	Saved with instrument state

Capcode

When the audio synthesizer format is set to POCSAG, pressing this key activates the Capcode input dialog.

Range	0 to 2097151
Default	0
Saved State	Saved with instrument state

Function Bits

When the audio synthesizer format is set to POCSAG, pressing this soft key activates a horizontal soft key menu where you can select the function bits.

Discrete Values	00, 01 ,10, 11
Default	00
Saved State	Saved with instrument state

POCSAG Message

When the audio synthesizer format is set to POCSAG, pressing this soft key activates a POCSAG Message dialog where you can choose the message content.

Discrete Values	Tone Only, NumericNum, NumericSet, AlphaNumUC, AlphaNumLC, AlphaNumSP, NumericCust, AlphaNumCust
Default	Tone Only
Saved State	Saved with instrument state
Notes	<p>Highlighting the NumericCust or AlphaNumCust selections allows editing of the respective custom Numeric or Alpha-numeric strings. Up to 16 characters may be entered. Entered NumericCust and AlphaNumCust strings are truncated or expanded to match Message Length.</p> <p>See "POCSAG Message Encoding Tables" on the next page.</p> <p>Tone Only: <empty string></p> <p>NumericNum: 0123456789</p> <p>NumericSet: The used characters in the Numeric set.</p> <p>AlphaNumUC: ABCDEFGHIJKLMNOPQRSTUVWXYZ</p> <p>AlphaNumLC: abcdefghijklmnopqrstuvwxyz</p> <p>AlphaNumSP: space!"#\$%()'*, -./:;<=>@[]^_{}~</p> <p>NumericCust: Anything in the Numeric set.</p> <p>AlphaNumCust: Anything in the Alpha-numeric set.</p>

POCSAG Message Encoding Tables

POCSAG Numeric Character Set	
Binary	Character
0000	0
0001	1
0010	2
0011	3
0100	4
0101	5
0110	6
0111	7
1000	8
1001	9
1010	Spare (not available)
1011	U
1100	-
1110	[
1111]

POCSAG Alphanumeric Character Set (7-bit ASCII)								
Decimal	Binary	Character	Decimal	Binary	Character	Decimal	Binary	Character
20	0100000	SPACE	52	1000000	@	84	1100000	`
21	0100001	!	53	1000001	A	85	1100001	a
22	0100010	"	54	1000010	B	86	1100010	b
23	0100011	#	55	1000011	C	87	1100011	c
24	0100100	\$	56	1000100	D	88	1100100	d
25	0100101	%	57	1000101	E	89	1100101	e
26	0100110	&	58	1000110	F	90	1100110	f
27	0100111	'	59	1000111	G	91	1100111	g
28	0101000	(60	1001000	H	92	1101000	h
29	0101001)	61	1001001	I	93	1101001	i
30	0101010	*	62	1001010	J	94	1101010	j
31	0101011	+	63	1001011	K	95	1101011	k
32	0101100	,	64	1001100	L	96	1101100	l
33	0101101	-	65	1001101	M	97	1101101	m
34	0101110	.	66	1001110	N	98	1101110	n
35	0101111	/	67	1001111	O	99	1101111	o
36	0110000	0	68	1010000	P	100	1110000	p
37	0110001	1	69	1010001	Q	101	1110001	q
38	0110010	2	70	1010010	R	102	1110010	r
39	0110011	3	71	1010011	S	103	1110011	s
40	0110100	4	72	1010100	T	104	1110100	t
41	0110101	5	73	1010101	U	105	1110101	u
42	0110110	6	74	1010110	V	106	1110110	v
43	0110111	7	75	1010111	W	107	1110111	w
44	0111000	8	76	1011000	X	108	1111000	x
45	0111001	9	77	1011001	Y	109	1111001	y
46	0111010	:	78	1011010	Z	110	1111010	z
47	0111011	;	79	1011011	[111	1111011	{
48	0111100	<	80	1011100	\	112	1111100	
49	0111101	=	81	1011101]	113	1111101	}
50	0111110	>	82	1011110	^	114	1111110	~
51	0111111	?	83	1011111	_	115	1111111	N/A

Message Length

When the audio synthesizer format is set to POCSAG, pressing this key activates the Message Length input dialog where you can set the message length from 0 to 60 characters.

Range	0 to 60
Default	16
Saved State	Saved with instrument state

Data Rate

When the audio synthesizer format is set to POCSAG, pressing this key activates the Data Rate input dialog where you can set the communication data rate.

Range	400 to 4800 bps
Default	1200 bps
Saved State	Saved with instrument state

Polarity

When the audio synthesizer format is set to POCSAG, pressing this soft key activates a horizontal soft key menu where you can select the POCSAG datastream polarity.

Discrete Values	Normal, Inverted
Default	Normal

Saved State	Saved with instrument state
Notes	When set to Normal, a logic high (1) results in a more positive frequency deviation in FM mode. A logic low (0) results in a more negative frequency deviation in FM mode. When set to Inverted, a logic high (1) results in more negative frequency deviation in FM mode. A logic low (0) results in a more positive frequency deviation in FM mode.

Error Bit

When the audio synthesizer format is set to POCSAG, pressing this key activates the Error Bit input dialog to set the error bit at the specified location in the POCSAG page bit stream.

Range	0 to 2200
Default	1200
Saved State	Saved with instrument state
Notes	The error bit allows targeted insertion of an error into the page to test a POCSAG decoder's error correction capability. The setting toggles the Error Bit in the POCSAG page bit stream, where the bit stream uses a 1-based index. If Error Bit is set to 0 (default), no bits are toggled. If Error Bit is set ≥ 1 , then the bit stream (Error Bit) is toggled.

General Sequence Synthesizer Format Soft Keys

The following soft keys are unique to the General Sequence audio synthesizer format.

Code Sequence

When the audio synthesizer format is set to General Sequence, pressing this key activates the Code Sequence dialog and a horizontal menu for entering an audio tone sequence for encoding on either the RF carrier or Mod Out port.

Pressing **Clear to End** in the horizontal menu clears the highlighted entry and all others to the right.

Discrete Values	0, 1, 2, 3, 4, 5, 6, 7, 8, 9, A, B, C, D, E, F, G, H, I, J
Default	None
Saved State	Saved with instrument state
Notes	Each entry can be one of 20 Tone Codes (0 to 9 and A to J) with the frequency, duration, and post tone delay specified in the General Sequence Table.

General Sequence Table

When the audio synthesizer format is set to General Sequence, pressing this soft key displays the General Sequence Table where you can enter create custom codes for use in sequences.

Notes	The table is populated with 20 Tone Codes (0 to 9 and A to J) with preset data for frequency, duration, and post-tone delay. The selected Tone Standard determines the preset data for each tone code. Regardless of the standard selected, each Tone Code can be edited for the current operating session or saved as a customized Sequence.
-------	---

Select Tone Standard

When the audio synthesizer format is set to General Sequence, pressing this key activates the Select Tone Standard dialog where you can select which standard is used for the preset Tone Code entries on the General Sequence table.

Discrete Values	None, CCIR1, CCIR2, PCCIR, CCITT, EEA, EIA, Euro, NATEL, MODAT, ZVEI1, ZVEI2, ZVEI3, DZVEI, PDZVEI
Default	None
Saved State	Saved with instrument state
Notes	Edited tables can be saved as a user-defined Sequence Definition. Reselecting and entering any Tone Standard restores the original table entries.

Synth Mode

When the audio synthesizer format is set to General Sequence, pressing this soft key activates a horizontal soft key menu where you can select the synthesized audio generator operating state.

Discrete Values	Off, Continuous, Burst
Default	Off
Saved State	Saved with instrument state
Notes	The status of the Synth Mode is shown in the Mode field.

Tone Frequency

When the audio synthesizer format is set to General Sequence, use the arrow keys to highlight a Tone Code to edit with the blue selection arrow, then press this soft key to activate a data entry window for customizing the Tone Frequency of the highlighted Tone Code.

Range	0 to 20000 Hz
Default	0 Hz
Saved State	Saved with instrument state

Tone Duration

When the audio synthesizer format is set to General Sequence, use the arrow keys to highlight a Tone Code to edit with the blue selection arrow, then press this soft key to activate a Tone duration dialog where you can enter a duration for a highlighted code duration.

Range	0 to 10 s
Default	0 s
Saved State	Saved with instrument state

Post-Tone Delay

When the audio synthesizer format is set to General Sequence, use the arrow keys to highlight a Tone Code to edit with the blue selection arrow, then press this soft key to activate a Post-Tone Delay dialog, where you can enter a duration of the delay following the transmitted tone.

Range	0 to 10 s
Default	0 s
Saved State	Saved with instrument state

Save Sequence Definition

When the audio synthesizer format is set to General Sequence, pressing this soft key activates the Save Sequence Definition dialog, where you can enter an alphanumeric filename for saving the sequence definition.

Range	A to Z and 0 to 9
Default	MY
Saved State	Saved with instrument state

Load Sequence Definition

When the audio synthesizer format is set to General Sequence, pressing this soft key activates a Load Sequence Definition dialog, where you can load a sequence definition.

Notes	Must have a saved sequence definition to activate this soft key.
-------	--

Export Sequence Definition

When the audio synthesizer format is set to General Sequence, pressing this soft key activates an Export Sequence Definition dialog, where you can select a sequence definition to save on an external USB.

Notes	Must have a saved sequence definition to activate this soft key.
-------	--

Delete Sequence Definition

When the audio synthesizer format is set to General Sequence, pressing this soft key activates a Delete Sequence Definition dialog, where you can delete a sequence definition.

Notes	Must have a saved sequence definition to activate this soft key.
-------	--

Sync to Code Entry

When the audio synthesizer format is set to General Sequence, pressing this soft key activates a Sync to Code Entry dialog, where you can select the status of code synchronization.

Discrete	No, Yes
----------	---------

Values	
Default	Yes
Saved State	Saved with instrument state
Notes	<p>Yes – Any Tone Code alphanumeric value entered into the Code Sequence field is initially populated into the associated position in the Duration and Delay Sequence fields. This matches the frequency, duration, and delay values for each tone in the Code Sequence to that shown on the Tone Code line entry in the table. If desired, these initially synchronized Duration and Delay sequence entries can be changed to other values from the table.</p> <p>No – The entries for the Duration and Delay Sequences are set independently of the Code Sequence, with duration and delay values from any Tone Code on the table.</p>

Duration Sequence

When the audio synthesizer format is set to General Sequence, pressing this soft key activates a Duration Sequence dialog, where you can enter a custom duration sequence as well as a horizontal soft key menu where you can clear the current Duration Sequence entry.

Discrete Values	0, 1, 2, 3, 4, 5, 6, 7, 8, 9, A, B, C, D, E, F, G, H, I, J
Default	0123456789ABCDEFGHIJ
Saved State	Saved with instrument state
Notes	<p>Clear to End – clears the highlighted entry and all others to the right.</p> <p>Each entry in the Duration Sequence is paired in positional order with the associated entry in the Code Sequence, which provides the tone frequency, and the Delay Sequence, which provides the post tone delay. A duration of zero is used for Code Sequence entries that do not have an associated Duration Sequence entry. Duration Sequence entries that do not have an associated Code Sequence entry are ignored</p>

Delay Sequence

When the audio synthesizer format is set to General Sequence, pressing this soft key activates a Delay Sequence dialog, where you can enter a custom duration sequence, as well as activates a horizontal soft key menu where you can clear the current Delay Sequence entry.

Discrete Values	0, 1, 2, 3, 4, 5, 6, 7, 8, 9, A, B, C, D, E, F, G, H, I, J
Default	0123456789ABCDEFGHIJ
Saved State	Saved with instrument state
Notes	Clear to End – clears the highlighted entry and all others to the right. Each entry in the Delay Sequence is paired in positional order with the associated entry in the Code Sequence, which provides the tone frequency, and the Duration Sequence, which provides the tone duration. A delay of zero is used for Code Sequence entries that do not have an associated Delay Sequence entry. Delay Sequence entries that do not have an associated Code Sequence entry are ignored.

DISPLAY Zone Soft Keys for Generate Mode

In Generate Mode, the DISPLAY Zone represents the controls for the time-based graticule measurements. Use these soft keys to configure your desired display.

Select Display (DISPLAY Zone menu)

Pressing this soft key activates a horizontal soft key menu where you can select the display mode.

Discrete Values	Spec An, Mod Scope, Oscilloscope, Bar Graphs
-----------------	--

Default	Spec An (disabled)
Saved State	Saved with instrument state
Notes	Frequency based analysis (spectrum analysis/bar graphs) is disabled during Generate Mode.

Vertical Scale (Modulation Scope submenu)

When display is set to Mod Scope, pressing this soft key activates a horizontal soft key menu where you can select the vertical scale-per-division.

Discrete Values	100, 200, 500 Hz and 1, 2, 5, 10, 20, 50 kHz
Default	1 kHz
Saved State	Saved with instrument state

Horizontal Scale (Modulation Scope submenu)

When display is set to Mod Scope, pressing this soft key displays the Horizontal Scale input dialog where you can select the horizontal scale.

Discrete Values	20, 50, 100, 200, 500 μ s and 1, 2, 5, 10, 20, 50, 100, 200, 500 ms and 1 s
Default	20 ms
Saved State	Saved with instrument state

Marker Mode (Modulation Scope submenu)

When display is set to Mod Scope, pressing this soft key activates a horizontal soft key menu where you can select the Marker type and operating state.

Discrete Values	Off, Delta V, Delta T, 1/Delta T
Default	Off
Saved State	Saved with instrument state
Notes	Off – Deactivates markers. Delta V – The numeric reading shows the difference in amplitude between marker positions. Delta T – The numeric reading shows the difference in time between marker positions. 1/DeltaT – The numeric reading shows the inverse of the time difference between markers, which can be used to determine the frequency of a repetitive waveform. Depending on the installed options, up to four markers can be enabled and selected for positioning while in Instrument Mode.

Toggle Marker (Modulation Scope submenu)

When the display is set to Mod Scope, pressing this soft key cycles through the available markers to activate one for repositioning. Active markers are yellow.

Trigger Mode (Modulation Scope submenu)

When display is set to Mod Scope, pressing this soft key activates a horizontal soft key menu where you can select the Modulation Scope Trigger type.

Discrete Values	Auto, Normal, Single
Default	Auto
Saved State	Saved with instrument state
Notes	<p>Auto – If a signal satisfying the Trigger Edge and Trigger Level settings is present, the display will sweep as in Normal Mode. If no signal satisfying the Trigger Edge and Trigger Level settings is present, then the display sweeps continuously until a signal satisfying the settings is acquired.</p> <p>Normal – The display sweeps only when the input signal satisfies the Trigger Edge and Trigger Level settings.</p> <p>Single – The display sweeps once after a key press is performed on the Single soft key if the signal satisfies the Trigger Edge and Trigger level settings.</p>

Trigger Level (Modulation Scope submenu)

When display is set to Mod Scope, pressing this soft key activates the Trigger Level dialog where you can enter the trigger threshold level in kHz.

Range	–200 to 200 kHz
Default	0 kHz
Saved State	Saved with instrument state

Trigger Edge (Modulation Scope submenu)

When display is set to Mod Scope, pressing this soft key activates a horizontal soft key menu where you can select the Modulation Scope trigger type.

Discrete Values	Rising, Falling, Either
Default	Rising
Saved State	Saved with instrument state

Vertical Position (Modulation Scope submenu)

When display is set to Mod Scope, activates a horizontal soft key menu where you can adjust the Modulation Scope vertical position up or down.

Discrete Values	Move Down, Move Up
Default	Move Down
Saved State	Saved with instrument state

Coupling (Oscilloscope submenu)

When display is set to Oscilloscope, pressing this soft key activates a Coupling dialog menu where you can select the input voltage coupling.

Discrete Values	DC, AC
Default	DC
Saved State	Saved with instrument state

Horizontal Scale (Oscilloscope submenu)

When display is set to Oscilloscope, pressing this softkey displays the Horizontal Scale input dialog where you can select the horizontal scale.

Discrete Values	20, 50, 100, 200, 500 μ s and 1, 2, 5, 10, 20, 50, 100, 200, 500 ms and 1 s																																																
Default	1 ms																																																
Saved State	Saved with instrument state																																																
Notes	<p>Digital Oscilloscopes are susceptible to aliasing, which can cause inaccurate signal reconstruction. The Maximum recommended input frequency for each horizontal scale setting is shown in the display area. For best results, follow the guidelines shown in the table below.</p> <table border="1"> <thead> <tr> <th>Horizontal Scale</th> <th>Max Signal Frequency</th> <th>Max Recommended Signal Frequency</th> </tr> </thead> <tbody> <tr> <td>20 μs</td> <td>50000 Hz</td> <td>50000 Hz</td> </tr> <tr> <td>50 μs</td> <td>50000 Hz</td> <td>20000 Hz</td> </tr> <tr> <td>100 μs</td> <td>50000 Hz</td> <td>10000 Hz</td> </tr> <tr> <td>200 μs</td> <td>25000 Hz</td> <td>5000 Hz</td> </tr> <tr> <td>500 μs</td> <td>10000 Hz</td> <td>2000 Hz</td> </tr> <tr> <td>1 ms</td> <td>5000 Hz</td> <td>1000 Hz</td> </tr> <tr> <td>2 ms</td> <td>2500 Hz</td> <td>500 Hz</td> </tr> <tr> <td>5 ms</td> <td>1000 Hz</td> <td>200 Hz</td> </tr> <tr> <td>10 ms</td> <td>500 Hz</td> <td>100 Hz</td> </tr> <tr> <td>20 ms</td> <td>250 Hz</td> <td>50 Hz</td> </tr> <tr> <td>50 ms</td> <td>100 Hz</td> <td>20 Hz</td> </tr> <tr> <td>100 ms</td> <td>50 Hz</td> <td>10 Hz</td> </tr> <tr> <td>200 ms</td> <td>25 Hz</td> <td>5 Hz</td> </tr> <tr> <td>500 ms</td> <td>10 Hz</td> <td>2 Hz</td> </tr> <tr> <td>1 s</td> <td>5 Hz</td> <td>1 Hz</td> </tr> </tbody> </table>	Horizontal Scale	Max Signal Frequency	Max Recommended Signal Frequency	20 μ s	50000 Hz	50000 Hz	50 μ s	50000 Hz	20000 Hz	100 μ s	50000 Hz	10000 Hz	200 μ s	25000 Hz	5000 Hz	500 μ s	10000 Hz	2000 Hz	1 ms	5000 Hz	1000 Hz	2 ms	2500 Hz	500 Hz	5 ms	1000 Hz	200 Hz	10 ms	500 Hz	100 Hz	20 ms	250 Hz	50 Hz	50 ms	100 Hz	20 Hz	100 ms	50 Hz	10 Hz	200 ms	25 Hz	5 Hz	500 ms	10 Hz	2 Hz	1 s	5 Hz	1 Hz
Horizontal Scale	Max Signal Frequency	Max Recommended Signal Frequency																																															
20 μ s	50000 Hz	50000 Hz																																															
50 μ s	50000 Hz	20000 Hz																																															
100 μ s	50000 Hz	10000 Hz																																															
200 μ s	25000 Hz	5000 Hz																																															
500 μ s	10000 Hz	2000 Hz																																															
1 ms	5000 Hz	1000 Hz																																															
2 ms	2500 Hz	500 Hz																																															
5 ms	1000 Hz	200 Hz																																															
10 ms	500 Hz	100 Hz																																															
20 ms	250 Hz	50 Hz																																															
50 ms	100 Hz	20 Hz																																															
100 ms	50 Hz	10 Hz																																															
200 ms	25 Hz	5 Hz																																															
500 ms	10 Hz	2 Hz																																															
1 s	5 Hz	1 Hz																																															

Vertical Scale (Oscilloscope submenu)

When display is set to Oscilloscope, pressing this softkey displays the Vertical Scale input dialog where you can select the vertical scale.

Discrete Values	50, 100, 200, 500 mV and 1, 2, 5, 10, 15, 20, 25 V
Default	1 V
Saved State	Saved with instrument state

Marker Mode (Oscilloscope submenu)

When display is set to Oscilloscope, pressing this soft key activates a horizontal soft key menu where you can select the select the Marker type and operating state.

Discrete Values	Off, Delta V, Delta T, 1/Delta T
Default	Off
Saved State	Saved with instrument state
Notes	<p>Off – Deactivates markers.</p> <p>Delta V – The numeric reading shows the difference in amplitude between marker positions.</p> <p>Delta T – The numeric reading shows the difference in time between marker positions.</p> <p>1/Delta T – The numeric reading shows the inverse of the time difference between markers, which can be used to determine the frequency of a repetitive waveform.</p> <p>Depending on the installed options, up to four markers can be enabled and selected for positioning while in Instrument Mode.</p>

Toggle Marker (Oscilloscope submenu)

When the display is set to Oscilloscope, pressing this soft key switches between Marker 1 and 2.

Trigger Mode (Oscilloscope submenu)

When display is set to Oscilloscope, pressing this soft key activates a horizontal soft key menu where you can select the Oscilloscope Trigger Mode.

Discrete Values	Auto, Normal, Single
Default	Auto
Saved State	Saved with instrument state
Notes	<p>Auto – If a signal satisfying the Trigger Edge and Trigger Level settings is present, the display will sweep as in Normal Mode. If no signal satisfying the Trigger Edge and Trigger Level settings is present, then the display sweeps continuously until a signal satisfying the settings is acquired.</p> <p>Normal – The display sweeps only when the input signal satisfies the Trigger Edge and Trigger Level settings.</p> <p>Single – The display sweeps once after a key press is performed on the Single soft key if the signal satisfies the Trigger Edge and Trigger level settings.</p>

Trigger Level (Oscilloscope submenu)

When display is set to Oscilloscope, pressing this soft key activates a Trigger Level dialog where you can enter the sweep trigger threshold level.

Range	-100 to 100
Default	0
Saved State	Saved with instrument state

Trigger Position (Oscilloscope submenu)

When display is set to Oscilloscope, pressing this soft key activates a Trigger Position dialog where you can select the amount of pre-threshold waveform displayed on the screen allocated to the waveform preceding the trigger threshold.

Discrete Values	10%, 50%, 90%
Default	50%
Saved State	Saved with instrument state

Trigger Edge (Oscilloscope submenu)

When display is set to Oscilloscope, pressing this soft key activates a horizontal soft key menu where you can select the Oscilloscope trigger type.

Discrete Values	Rising, Falling, Either
Default	Rising
Saved State	Saved with instrument state

Vertical Position (Oscilloscope submenu)

When display is set to Oscilloscope, pressing this soft key activates a horizontal soft key menu where you can adjust the Oscilloscope up or down.

Discrete	Move Down, Move Up
----------	--------------------

Values	
Default	Move Down
Saved State	Saved with instrument state

Set DC Offset (Oscilloscope submenu)

When display is set to Oscilloscope, pressing this soft key zeroes out the Oscilloscope to account for a DC offset.

Notes	With the Meter In port disconnected, press the soft key to eliminate the offset. The compensation is stored permanently in the analyzer until the next time this soft key is pressed.
-------	---

METER Zone Soft Keys for Generate Mode

In Generate Mode, the METER Zone displays the controls for configuring supplementary metering devices. Use these soft keys to apply general purpose and specialized instruments providing detailed analysis of the recovered baseband content from RF signals.

Select Meter (METER Zone menu)

Activates a horizontal soft key menu where you can select the metering device.

Discrete Values	Power Meter, Voltmeter, SINAD/Distortion, Decoder, Frequency Counter, RF Scan, SNRMeter
Default	Power Meter
Saved State	Saved with instrument state
Notes	RF Scan is not available in Generate Mode.

Power Meter (METER Zone menu)

Opens the Power Meter display and submenu.

Range (Power Meter submenu)

When the meter is set to Power Meter, pressing this soft key activates a horizontal soft key menu where you can select the power meter range.

Discrete Values	5, 10, 50, 150 W
Default	50 W
Saved State	Saved with instrument state
Notes	For best accuracy, disable the Pre-amplifier in Monitor Mode and set the Gen Port in Generate Mode to RF In/Out.

Voltmeter (METER Zone menu)

Opens the Voltmeter display and submenu.

Select Voltmeter Mode (Voltmeter submenu)

When the meter is set to Voltmeter, pressing this soft key activates a horizontal soft key menu where you can select the voltage mode for the Voltmeter.

Discrete Values	AC Volts, DC Volts
Default	AC Volts
Saved State	Saved with instrument state
Notes	AC Volts measures AC voltage applied to the Meter In port. The dBm computation assumes an impedance of 600Ω.

Coupling (Voltmeter submenu)

When the meter is set to Voltmeter, pressing this soft key activates a Coupling dialog menu where you can select the input voltage coupling.

Discrete Values	DC, AC
Default	DC
Saved State	Saved with instrument state

AC Range (Voltmeter submenu)

When the meter is set to Voltmeter, pressing this soft key activates a horizontal soft key menu where you can select the power meter AC voltage range.

Discrete Values	Auto, 1 V, 10 V, 70 V
Default	Auto
Saved State	Saved with instrument state
Notes	The range on AC and DC must be 1 or 10 Volts to use 600 Ohm Input Impedance.

Set dBr Reference (Voltmeter submenu)

When the meter is set to Voltmeter and Voltmeter mode is set to AC, pressing this soft key sets a reference input voltage.

Notes	When selected, dBm measurements are frozen, and a dBr indicator appears. The dBr indicates the normalized measurement between the reference input voltage and the current input voltage.
-------	--

Clear dBr Reference (Voltmeter submenu)

When the meter is set to Voltmeter and Voltmeter mode is set to AC, pressing this soft key clears the dBr reference input voltage.

Voltage Units (Voltmeter submenu)

When the meter is set to Voltmeter, pressing this soft key activates a horizontal soft key menu where you can select the power meter range.

Discrete Values	Volts (V), Millivolts (mV), Decibel Volts (dBV)
Default	Volts (V)
Saved State	Saved with instrument state

DC Range (Voltmeter submenu)

When the meter is set to Voltmeter, pressing this soft key activates a horizontal soft key menu where you can select the power meter DC voltage range.

Discrete Values	Auto, 1 V, 10 V, 70 V
Default	Auto
Saved State	Saved with instrument state
Notes	The range on AC and DC must be 1 or 10 Volts to use 600 Ohm Input Impedance.

SINAD/Distortion (METER Zone menu)

Opens the SINAD/Distortion display and submenu.

Select Audio Measurement (SINAD/Distortion submenu)

When the meter is set to SINAD/Ext Distortion, pressing this soft key activates a horizontal soft key menu where you can select the distortion source.

Discrete Values	SINAD/Ext Distortion, Internal Distortion
Default	SINAD/Ext Distortion
Saved State	Saved with instrument state

Decoder (METER Zone menu)

Opens the Decoder display and submenu.

Select Decoder Type (Decoder submenu)

When the meter is set to Decoder, pressing this soft key activates a horizontal soft key menu where you can select the decoder type.

Discrete Values	PL/Period Counter, DPL Decode, DTMF Decode, 2-Tone Decode, 5/6 Tone Decode, General Sequence
Default	PL/Period Counter
Saved State	Saved with instrument state

Reset (Decoder submenu)

When the meter is set to Decoder and Decoder Type is set to DTMF Decode, pressing this soft key resets the decoder.

Decode (Decoder submenu)

When the meter is set to Decoder, pressing this soft key activates a horizontal soft key menu where you can select start and stop the decoding.

Discrete Values	Stop, Start
Default	Stop
Saved State	Saved with instrument state
Notes	This function is available one for the 2-Tone Decode, 5/6 Tone Decode, General Sequence decoder types.

Decode to Standard (Decoder submenu)

When the meter is set to Decoder, pressing this soft key activates a horizontal soft key menu where you can select the decoding standard to be used.

Discrete Values	None, CCIR1, CCIR2, PCCIR, CCITT, EEA, EIA, Euro, NATEL, MODAT, ZVEI1, ZVEI2, ZVEI3, PZVEI, DZVEI, PDZVEI
Default	None
Saved State	Saved with instrument state
Notes	This function is available one for the General Sequence decoder type.

Low Pass Filter (Decoder submenu)

When the meter is set to Decoder, pressing this soft key activates a horizontal soft key menu where you can select the high pass frequency.

Discrete Values	300 Hz, 3 kHz, 20 kHz
Default	300 Hz
Saved State	Saved with instrument state

High Pass Filter (Decoder submenu)

When the meter is set to Decoder, pressing this soft key activates a horizontal soft key menu where you can select the high pass frequency.

Discrete Values	1 Hz, 300 Hz, 3 kHz
Default	1 Hz
Saved State	Saved with instrument state

Input Decoding (Decoder submenu)

When the meter is set to Decoder, pressing this soft key displays a Input Decoding dialog menu where you can select which decoding source to use.

Discrete Values	Internal, External
Default	Internal
Saved State	Saved with instrument state

Frequency Counter (METER Zone menu)

Opens the Frequency Counter display and submenu.

Reset (Frequency Counter submenu)

When the meter is set to Frequency Counter, pressing this soft key resets the frequency counter.

Input Decoding (Frequency Counter submenu)

When the meter is set to Frequency Counter, pressing this soft key displays a Input Decoding dialog menu where you can select which decoding source to use.

Discrete Values	Internal, External
Default	Internal
Saved State	Saved with instrument state

Resolution (Frequency Counter submenu)

When the meter is set to Frequency Counter, pressing this soft key activates a horizontal soft key menu where you can select the frequency counter resolution.

Discrete Values	0.001 Hz, 0.01 Hz, 0.1 Hz, 1.0 Hz, 10 Hz
Default	1.0 Hz
Saved State	Saved with instrument state

RF Scan (METER Zone menu)

Opens the RF Scan display and submenu.

Start Frequency (RF Scan submenu)

When the meter is set to RF Scan, pressing this key displays the Start Frequency dialog where you can input the start frequency to be used in the RF scan.

Range	1 to 2991 MHz
Default	400 MHz
Saved State	Saved with instrument state

Stop Frequency (RF Scan submenu)

When the meter is set to RF Scan, pressing this key displays the Stop Frequency dialog where you can input the start frequency to be used in the RF scan.

Range	1 to 2991 MHz
Default	600 MHz
Saved State	Saved with instrument state

Scan (RF Scan submenu)

When the meter is set to RF Scan, pressing this soft key activates a horizontal soft key menu where you can select the scanning mode.

Discrete Values	Off, Single, Auto
Default	Off

Saved State	Saved with instrument state
Notes	<p>Off – Deactivates scanning.</p> <p>Single – Sweep the span defined by the Start and Stop Frequency parameters once.</p> <p>Auto – Continuously sweeps the span defined by the Start and Stop Frequency parameters.</p> <p>The signal captured by the scan will automatically set the Monitor Frequency to the closest channel in the selected RF Bandwidth. For example, if the signal captured by the receiver in a 12.5 kHz BW is 390.011911 kHz, then the Monitor Frequency will be set to 390.0125 (i.e., the ideal channel frequency). This ensures that the Frequency Error meter will display the offset from this ideal.</p>

SNR (METER Zone menu)

Opens the Signal-to-Noise Ratio display.

10 Duplex Mode Soft Keys

The Duplex Mode screen is divided into four functional Zones: RF, AUDIO, DISPLAY, and METER. This chapter contains detailed descriptions of the soft keys accessible in each Zone. Each soft key is defined, along with its range, discrete, default, and saved state values.

"RF Zone Soft Keys for Duplex Mode" on the next page includes the RF parameters associated with configuring the transceiver.

"AUDIO Zone Soft Keys for Duplex Mode" on page 468 includes the parameters associated with RF carrier modulation.

"DISPLAY Zone Soft Keys for Duplex Mode" on page 496 includes the parameters associated with configuring your desired display.

"METER Zone Soft Keys for Duplex Mode" on page 514 includes the parameters associated with configuring general purpose and specialized instruments providing detailed analysis of the recovered baseband content from RF signals.

RF Zone Soft Keys for Duplex Mode

In Duplex Mode, the RF Zone contains the controls for the transceiver RF inputs and RF outputs. Use these soft keys to configure your transceiver including the frequency and power of your RF stimulus and measurement as well as which port you would like to transmit on (RF In/Out or RF Gen Port) or analyze (RF In/Out or Antenna).

Monitor Frequency

Displays the Monitor Frequency dialog where you can enter the desired value to set the center frequency on the transceiver display.

Range	250 kHz to 3.0 GHz
Default	500 MHz
Saved State	Saved with instrument state

Duplex Offset

Displays the Duplex Offset dialog where you can enter the desired value to set the offset between the Generate and Monitor frequencies.

Range	-1.0 GHz to +1.0 GHz
Default	0 MHz
Saved State	Saved with instrument state

Generate Frequency

Displays the Generate Frequency dialog where you can set the desired transmission frequency for the RF generator.

Range	250 kHz to 3.0 GHz
Default	500 MHz
Saved State	Saved with instrument state

Modulation Type

Activates a horizontal soft key menu where you can select the transceiver modulation and demodulation mode.

Discrete Values	FM, AM, USB, LSB
Default	FM
Saved State	Saved with instrument state
Notes	Output Level upper limits are reduced in AM to accommodate peak power levels.

Output Units

Activates a horizontal soft key menu where you can select the measurement units for the output level display.

Discrete Values	dBm, Volts, mV, μ V, Watts, mW, μ W
Default	dBm
Saved State	Saved with instrument state

Output Level

Displays the Output Level dialog, where you can enter the desired output power level.

Range	RF Gen Out port: –95 dBm to 5 dBm RF In/Out port: –130 dBm to –30 dBm
Default	–50 dBm
Saved State	Saved with instrument state
Notes	When Modulation Type is AM, the upper limits are –1 dBm and –36 dBm respectively. If the R8_Gen_Ext Option is enabled, then the RF Gen Port range is –125 dBm to +5 dBm.

Gen Port

Displays the Gen Port dialog where you can select the desired output port for the transceiver.

Discrete Values	RF In/Out, Gen Out
Default	RF In/Out
Saved State	Saved with instrument state
Notes	If RF Level Offset is enabled, the Gen Port label is cyan-colored, indicating that Output Level amplitudes are adjusted by the Gen Port-specific offset.

Bandwidth

Activates a horizontal soft key menu where you can select transceiver resolution (IF detection) bandwidth.

Discrete Values	6.25 kHz (Narrow), 8.33 kHz (Narrow), 10 kHz (Narrow), 12.5 kHz (Narrow), 25 kHz (Wide), 50 kHz (Wide), 100 kHz (Wide), 200 kHz (Wide)
-----------------	--

Default	25 kHz (Wide)
Saved State	Saved with instrument state
Notes	For best measurement quality, always set an IF bandwidth no wider than necessary for the signal carrier of interest. Example: Typical channel spacing for modern narrowband two-way radio is 12.5 kHz. Monitor IF bandwidths that are wider than needed for the channel spacing, allow more noise in the measurement, and degrade the quality of readings for deviation, frequency error, SINAD, etc.

Attenuation

Displays the Attenuation dialog where you can select the desired input port attenuation for the transceiver.

Discrete Values	0 to 62 dB in 2 dB steps
Default	0 dB
Saved State	Saved with instrument state

Pre-Amplifier

Displays the Pre-Amplifier dialog where you can activate and deactivate the amplification.

Discrete Values	On, Off
Default	Off
Saved State	Saved with instrument state

Notes	<p>AMP appears next to the Attenuation setting in the RF Zone whenever the Pre-Amplifier is active.</p> <p>By default, the pre-amplifier Auto-Off feature disables the pre-amplifier for best accuracy during broadband power (Watt Meter) measurements. When enabled, avoid input overload and erroneous signal strength readings by using the pre-amplifier only under the following conditions:</p> <table border="1" data-bbox="407 457 1393 577"> <thead> <tr> <th data-bbox="407 457 581 499">Monitor Port</th> <th data-bbox="581 457 1393 499">Maximum input level for using pre-amplifier</th> </tr> </thead> <tbody> <tr> <td data-bbox="407 499 581 541">Antenna</td> <td data-bbox="581 499 1393 541">(Input signal in dBm – Attenuator setting) is equal or less than –40 dBm</td> </tr> <tr> <td data-bbox="407 541 581 577">RF In/Out</td> <td data-bbox="581 541 1393 577">(Input signal in dBm – Attenuator setting) is equal or less than –10 dBm</td> </tr> </tbody> </table>	Monitor Port	Maximum input level for using pre-amplifier	Antenna	(Input signal in dBm – Attenuator setting) is equal or less than –40 dBm	RF In/Out	(Input signal in dBm – Attenuator setting) is equal or less than –10 dBm
Monitor Port	Maximum input level for using pre-amplifier						
Antenna	(Input signal in dBm – Attenuator setting) is equal or less than –40 dBm						
RF In/Out	(Input signal in dBm – Attenuator setting) is equal or less than –10 dBm						

Mon Port

Displays the Mon Port dialog where you can select the desired input port for the transceiver.

Discrete Values	RF In/Out, Antenna
Default	RF In/Out
Saved State	Saved with instrument state
Notes	<p>If RF Level Offset is enabled, the Mon Port label is cyan-colored, indicating that RX measurements are adjusted by the Mon Port-specific offset.</p> <p>CAUTION Do not apply input power to the Antenna input port.</p> <hr data-bbox="407 1312 1393 1318"/>

Input Source

Activates a horizontal soft key menu where you can select transceiver input source.

Discrete Values	Auto, Input Level, Power Meter
Default	Auto
Saved State	Saved with instrument state
Notes	When the RF input power on the RF In/Out port is above +20 dBm (100 mW), the analyzer utilizes a broadband power detector for the measurement. The Input Level field in the RF Zone changes to Power Meter to indicate this measurement mode. This disables TDMA signals from auto-switching between input sources during unused slots.

Input Units

Activates a horizontal soft key menu where you can select the units for the transceiver input source.

Discrete Values	dBm, Volts, mV, μ V, Watts, mW, μ W
Default	dBm
Saved State	Saved with instrument state

Freq Error Units

Activates a horizontal soft key menu where you can select the units of measure for the transceiver's frequency error.

Discrete Values	Hertz, PPM
Default	Hertz
Saved State	Saved with instrument state

AUDIO Zone Soft Keys for Duplex Mode

In Duplex Mode, the AUDIO Zone displays the controls for modulating/demodulating the RF carrier. Use these soft keys to recover the transmitted/received message.

Mod Port Mode

Displays a dialog menu where you can select a Mod Port Mode option.

Discrete Values	In, Out
Default	Out
Saved State	Saved with instrument state
Notes	Remove voltage sources before selecting Out. If input voltage is detected at the port, the Out selection is ignored, and an alert is displayed at the bottom of the display.

Fixed 1 kHz Level

Displays the Fixed 1 kHz Level dialog where you can enter the desired value for the tone generator amplitude.

Range	0 to 12.5 kHz Deviation (Generator Mode), 0 to 8 V (Monitor Mode)
Default	0 kHz, 0 V
Saved State	Saved with instrument state

Fixed 1 kHz Mode

Activates a horizontal soft key menu where you can select the tone generator operating state.

Discrete Values	Off, Continuous
Default	Off
Saved State	Saved with instrument state
Notes	When the tone is activated, the Fixed 1kHz field is highlighted in green.

Synth Level

Displays the Synth Level dialog where you can enter the amplitude for the synthesized audio generator.

Range	0 to 12.5 kHz Deviation (Generator Mode), 0 to 8 V (Monitor Mode)
Default	0 kHz, 0 V
Saved State	Saved with instrument state
Notes	This is an independent generator used for encoded audio such as PL, DPL, A/B Sequence, etc.

Format

NOTE

This section describes the Duplex Mode AUDIO Zone soft keys in their factory default configuration order. Thus, the PL format soft key is listed below as the default encoding format for the synthesized audio generator in Duplex Mode. Soft keys for the other synthesized audio generator formats such as DPL, DPL Invert, A/B Sequence, 5/6 Tone, POCSAG, and General Sequence, as well as their unique submenu soft keys, begin with "**DPL and DPL Invert Synthesizer Formats Soft Key**" on page 480.

Activates a horizontal soft key menu where you can select the encoding format for the synthesized audio generator.

Discrete Values	PL, DPL, DPL Invert, A/B Sequence, 5/6 Tone, POCSAG, General Sequence
Default	PL
Saved State	Saved with instrument state
Notes	Selecting a format instantiates the active encoding type for the audio synthesizer. This is an independent synthesizer for encoding audio stimulus such as PL, DPL, or A/B Sequence. This encoded signal is available at the Mod In/Out port.

Synth Mode

Activates a horizontal soft key menu where you can select the synthesized audio generator operating state.

Discrete Values	Off, Continuous
Default	Off
Saved State	Saved with instrument state

PL Code

When the audio synthesizer format is set to PL, pressing this soft key displays the PL Code dialog where you can enter codes for the Motorola Private-Line coded squelch signaling format. The following table lists valid codes and their frequencies.

Code	Frequency (Hz)	Code	Frequency (Hz)	Code	Frequency (Hz)	Code	Frequency (Hz)

XZ	67.0	ZB	97.0	4Z	136.5	7A	192.8
WZ	69.3	1Z	100.0	4A	141.3	M1	203.5
XA	71.9	1A	103.5	4B	146.2	8Z	206.5
WA	74.4	1B	107.2	5Z	151.4	M2	210.7
XB	77.0	2Z	110.9	5A	156.7	M3	218.1
WB	79.7	2A	114.8	5B	162.2	M4	225.7
YZ	82.5	2B	118.8	6Z	167.9	9Z	229.1
YA	85.4	3Z	123.0	6A	173.8	M5	233.6
YB	88.5	3A	127.3	6B	179.9	M6	241.8
ZZ	91.5	3B	131.8	7Z	192.8	M7	250.3
ZA	94.8						

PL Code Table

When the audio synthesizer format is set to PL, pressing this soft key displays the PL Code Table where you can enter codes for the Motorola Private-Line coded squelch signaling format. The following table lists valid codes and their frequencies.

Code	Frequency (Hz)	Code	Frequency (Hz)	Code	Frequency (Hz)	Code	Frequency (Hz)
XZ	67.0	ZB	97.0	4Z	136.5	7A	192.8
WZ	69.3	1Z	100.0	4A	141.3	M1	203.5
XA	71.9	1A	103.5	4B	146.2	8Z	206.5
WA	74.4	1B	107.2	5Z	151.4	M2	210.7
XB	77.0	2Z	110.9	5A	156.7	M3	218.1
WB	79.7	2A	114.8	5B	162.2	M4	225.7
YZ	82.5	2B	118.8	6Z	167.9	9Z	229.1
YA	85.4	3Z	123.0	6A	173.8	M5	233.6
YB	88.5	3A	127.3	6B	179.9	M6	241.8
ZZ	91.5	3B	131.8	7Z	192.8	M7	250.3
ZA	94.8						

Tone A Level

When the audio synthesizer format is set to PL, pressing this soft key displays the Tone A Level dialog where you can enter the amplitude for the A Variable tone generator.

Range	0 to 12.5 kHz Deviation (Generator Mode), 0 to 8 V (Monitor Mode)
Default	0 kHz, 0 V
Saved State	Saved with instrument state
Notes	When modulation type is set to AM, Tone A Level utilizes units of %.

Tone A Frequency

When the audio synthesizer format is set to PL, pressing this soft key displays the Tone A Frequency dialog where you can enter the frequency for the A Variable tone generator.

Range	0 to 20000 Hz
Default	10 Hz
Saved State	Saved with instrument state

Tone A Mode

When the audio synthesizer format is set to PL, pressing this soft key activates a horizontal soft key menu where you can select the operating mode for the A Variable tone generator.

Discrete Values	Off, Continuous, Burst
-----------------	------------------------

Default	Off
Saved State	Saved with instrument state

Tone B Level

When the audio synthesizer format is set to PL, pressing this soft key displays the Tone B Level dialog where you can enter the amplitude for the B Variable tone generator.

Range	0 to 12.5 kHz Deviation (Generator Mode), 0 to 8 V (Monitor Mode)
Default	0 kHz, 0 V
Saved State	Saved with instrument state
Notes	When modulation type is set to AM, Tone B Level utilizes units of %.

Tone B Frequency

When the audio synthesizer format is set to PL, pressing this soft key displays the Tone B Frequency dialog where you can enter the frequency for the B Variable tone generator.

Range	0 to 20000 Hz
Default	2000 Hz
Saved State	Saved with instrument state

Tone B Mode

When the audio synthesizer format is set to PL, pressing this soft key activates a horizontal soft key menu where you can select the operating mode for the B Variable tone generator.

Discrete Values	Off, Continuous, Burst
Default	Off
Saved State	Saved with instrument state

Tone C Level

When the audio synthesizer format is set to PL, pressing this soft key displays the Tone B Level dialog where you can enter the amplitude for the C Variable tone generator.

Range	0 to 12.5 kHz Deviation (Generator Mode), 0 to 8 V (Monitor Mode)
Default	0 kHz, 0 V
Saved State	Saved with instrument state
Notes	When modulation type is set to AM, Tone C Level utilizes units of %.

Tone C Frequency

When the audio synthesizer format is set to PL, pressing this soft key displays the Tone B Frequency dialog where you can enter the frequency for the C Variable tone generator.

Range	0 to 100000 Hz
Default	30000 Hz
Saved State	Saved with instrument state

Tone C Mode

When the audio synthesizer format is set to PL, pressing this soft key activates a horizontal soft key menu where you can select the operating mode for the C Variable tone generator.

Discrete Values	Off, Continuous, Burst
Default	Off
Saved State	Saved with instrument state
Notes	Tone C is only available in Generate and Duplex mode. Tone C ONLY outputs on RF signal and is NOT available on Mod Out port.

DTMF Level

When the audio synthesizer format is set to PL, pressing this soft key displays the DTMF Level dialog where you can enter the amplitude for the Dual Tone Multi-Frequency tone generator.

Range	0 to 12.5 kHz
Default	0 kHz
Saved State	Saved with instrument state
Notes	When modulation type is set to AM, DTMF Level utilizes units of %.

DTMF Mode

When the audio synthesizer format is set to PL, pressing this soft key activates a horizontal soft key menu where you can select the operating mode for the Dual Tone Multi-Frequency tone generator.

Discrete Values	Off, Continuous, Burst
Default	Off
Saved State	Saved with instrument state

DTMF Code

When the audio synthesizer format is set to PL, pressing this soft key opens the DTMF Code dialog where you can enter a code sequence for the Dual Tone Multi-Frequency tone generator. Pressing this key also activates a horizontal soft key menu where you can insert a space in the code sequence or clear the present values from the cursor to the end.

Discrete Values	0, 1, 2, 3, 4, 5, 6, 7, 8, 9, 0, *, #, A, B, C, D
Default	01234567890*#ABCD
Saved State	Saved with instrument state
Notes	Pressing the alphanumeric keypad allows direct numeric entry, and alpha characters are entered by cycling through repeated presses of the appropriate numeric key.

DTMF Table

When the audio synthesizer format is set to PL, pressing this soft key activates soft keys and the DTMF Table that provides more control when generating a DTMF Code sequence.

Tone Duration

When the audio synthesizer format is set to PL, pressing this soft key opens the Tone Duration dialog where you can enter the code sequence duration for the Dual Tone Multi-Frequency tone generator.

Range	40 to 9999 ms
Default	100 ms
Saved State	Saved with instrument state

Inter-Digit Delay

When the audio synthesizer format is set to PL, pressing this soft key opens the Inter-Digit Delay dialog where you can enter the delay between individual digits broadcast by the code sequence for the Dual Tone Multi-Frequency tone generator.

Range	20 to 9999 ms
Default	70 ms
Saved State	Saved with instrument state

Single Digit

When the audio synthesizer format is set to PL, pressing this soft key activates a horizontal soft key menu where you can choose a single digit to broadcast as the code sequence for the Dual Tone Multi-Frequency tone generator.

Discrete Values	*, #, A, B, C, D, 0 to 9
Default	*
Saved State	Saved with instrument state
Notes	Pressing the alphanumeric keypad allows direct numeric entry.

Microphone Level

When the audio synthesizer format is set to PL, pressing this soft key activates a Microphone level dialog where you can enter the level in kHz.

Range	0 to 12.5 kHz
Default	0 kHz
Saved State	Saved with instrument state
Notes	When modulation type is set to AM, Microphone Level utilizes units of %.

Microphone Mode

When the audio synthesizer format is set to PL, pressing this soft key activates a horizontal soft key menu where you can enable or disable modulation from an external microphone attached to the Mic In port of the analyzer.

Discrete Values	Off, Continuous
Default	Off
Saved State	Saved with instrument state
Notes	Pressing the PTT button on the external microphone switches the analyzer into Generate Mode. Modulation from the microphone is applied to the carrier when the mode is set to Continuous.

Mod In Port Level

When the audio synthesizer format is set to PL, pressing this soft key activates a dialog where you can enter the level in kHz.

Range	0 to 12.5 kHz
Default	0 kHz
Saved State	Saved with instrument state
Notes	The audio signals must equal $\pm 1 V_{pk}$ to provide a reference for accurate display of the applied modulation level. When modulation type is set to AM, Mod In Port Level utilizes units of %.

Mod In Port Mode

When the audio synthesizer format is set to PL, pressing this soft key activates a horizontal soft key menu where you can select the Mod In Port Mode.

Discrete Values	Off, Continuous
Default	Off
Saved State	Saved with instrument state
Notes	Remove voltage sources before selecting “Out.” If input voltage is detected at the port, the “Out” selection is ignored, and an alert is displayed at the bottom of the display.

High Pass Filter

When the audio synthesizer format is set to PL, pressing this soft key activates a horizontal soft key menu where you can select an audio filter high pass frequency.

Discrete Values	1 Hz, 300 Hz, 3 kHz
-----------------	---------------------

Default	300 Hz
Saved State	Saved with instrument state
Notes	For best audio and measurement quality, always set an audio pass band no wider than necessary for the signal of interest. Example: A typical two-way radio pass band is 300 Hz to 3 kHz. Pass bands wider than necessary allow more noise in the measurement and degrade the audio quality and the readings for deviation, frequency error, SINAD, etc.

Low Pass Filter

When the audio synthesizer format is set to PL, pressing this soft key activates a horizontal soft key menu where you can select an audio filter low pass frequency.

Discrete Values	300 Hz, 3 kHz, 20 kHz
Default	300 Hz
Saved State	Saved with instrument state
Notes	For best audio and measurement quality, always set an audio pass band no wider than necessary for the signal of interest. Example: A typical two-way radio pass band is 300 Hz to 3 kHz. Pass bands wider than necessary allow more noise in the measurement and degrade the audio quality and the readings for deviation, frequency error, SINAD, etc.

DPL and DPL Invert Synthesizer Formats Soft Key

NOTE

The following sections describe the soft keys for the supplementary audio synthesizer formats: DPL, DPL Invert, A/B Sequence, 5/6 Tone, POCSAG, and General Sequence. For the default audio synthesizer format, see **"PL Code" on page 470**.

The following soft key is unique to the DPL and DPL Invert audio synthesizer formats.

DPL Code

When the audio synthesizer format is set to DPL, pressing this soft key displays the DPL Code dialog where you can enter codes for the Motorola Digital-Private-Line coded squelch signaling format.

Range	000 to 777
Default	000
Saved State	Saved with instrument state

A/B Sequence Synthesizer Format Soft Keys

The following soft keys are unique to the A/B Sequence audio synthesizer format.

A/B Sequence Code

When the audio synthesizer format is set to A/B Sequence, pressing this soft key activates a horizontal soft key menu where you can select one of four timing sequences for the two-tone sequential paging format.

Discrete Values	1, 2, 3, 4
Default	1
Saved State	Saved with instrument state
Notes	Sequences 1 and 2 utilize fixed timing for standard "tone" and "tone/voice" pagers, while sequences 3 and 4 may be customized through numeric entries by the user.

A/B Sequence Table

When the audio synthesizer format is set to A/B Sequence, pressing this soft key activates soft keys and the A/B Sequence Table that provides more control when generating an A/B Code sequence.

Sequence

When the audio synthesizer format is set to A/B Sequence, pressing this soft key activates a horizontal soft key menu where you can select one of four timing sequences for the two-tone sequential paging format.

Discrete Values	1, 2, 3, 4
Default	1
Saved State	Saved with instrument state
Notes	Sequences 1 and 2 utilize fixed timing for standard "tone" and "tone/voice" pagers, while sequences 3 and 4 may be customized through numeric entries by the user.

Sequence 3/4 Tone A Duration

When the audio synthesizer format is set to A/B Sequence, pressing this soft key activates a Tone A duration dialog.

Range	0 to 9.99 s
Default	0 s
Saved State	Saved with instrument state
Notes	This function only applies to sequence 3 and 4, with 3/4 being 3 or 4 depending on the selected channel.

Sequence 3/4 Tone A Delay

When the audio synthesizer format is set to A/B Sequence, pressing this soft key activates a Tone A delay dialog.

Range	0 to 9.99 s
Default	0 s
Saved State	Saved with instrument state
Notes	This function only applies to sequence 3 and 4, with 3/4 being 3 or 4 depending on the selected channel.

Sequence 3/4 Tone B Duration

When the audio synthesizer format is set to A/B Sequence, pressing this soft key activates the Tone B duration dialog.

Range	0 to 9.99 s
Default	0 s
Saved State	Saved with instrument state
Notes	This function only applies to sequence 3 and 4, with 3/4 being 3 or 4 depending on the selected channel.

Sequence 3/4 Tone B Delay

When the audio synthesizer format is set to A/B Sequence, pressing this soft key activates the Tone B delay dialog.

Range	0 to 9.99 s
-------	-------------

Default	0 s
Saved State	Saved with instrument state
Notes	This function only applies to sequence 3 and 4, with 3/4 being 3 or 4 depending on the selected channel.

5/6 Tone Synthesizer Format Soft Keys

The following soft keys are unique to the 5/6 Tone audio synthesizer format.

5/6 Tone

When the audio synthesizer format is set to 5/6 Tone, pressing this soft key activates a horizontal submenu and 5/6 Tone dialog, where you can enter a 5/6 tone sequence.

Discrete Values	0, 1, 2, 3, 4, 5, 6, 7, 8, 9, R, X
Default	R-12345X
Saved State	Saved with instrument state
Notes	The first digit preceding the hyphen is the preamble tone for activating one of ten battery-saver groups. The R-Repeat key or "R" tone is used in place of a repeated digit. After hearing the tone, the operator may assume that the prior digit is being transmitted again. If the digit is repeated a third time, the original tone is transmitted. A sixth or "X" tone is optional for pagers that support this function. The "X" tone indicates that a different beep pattern is used in place of that used for the standard 5 tone response. Pressing the 6-Tone soft key adds the "X" tone to the transmission.

POCSAG Synthesizer Format Soft Keys

The following soft keys are unique to the POCSAG audio synthesizer format.

POCSAG Table

When the audio synthesizer format is set to POCSAG, pressing this soft key displays the POCSAG Table where you can enter codes for the Motorola Private-Line coded squelch signaling format.

Discrete Values	Tone Only, NumericNum, NumericSet, AlphaNumUC, AlphaNumLC, AlphaNumSP, NumericCust, AlphaNumCust
Default	Tone Only
Saved State	Saved with instrument state

Capcode

When the audio synthesizer format is set to POCSAG, pressing this key activates the Capcode input dialog.

Range	0 to 2097151
Default	0
Saved State	Saved with instrument state

Function Bits

When the audio synthesizer format is set to POCSAG, pressing this soft key activates a horizontal soft key menu where you can select the function bits.

Discrete Values	00, 01 ,10, 11
Default	00
Saved State	Saved with instrument state

POCSAG Message

When the audio synthesizer format is set to POCSAG, pressing this soft key activates a POCSAG Message dialog where you can choose the message content.

Discrete Values	Tone Only, NumericNum, NumericSet, AlphaNumUC, AlphaNumLC, AlphaNumSP, NumericCust, AlphaNumCust
Default	Tone Only
Saved State	Saved with instrument state
Notes	<p>Highlighting the NumericCust or AlphaNumCust selections allows editing of the respective custom Numeric or Alpha-numeric strings. Up to 16 characters may be entered. Entered NumericCust and AlphaNumCust strings are truncated or expanded to match Message Length.</p> <p>Tone Only: <empty string></p> <p>NumericNum: 0123456789</p> <p>NumericSet: The used characters in the Numeric set. See table below.</p> <p>AlphaNumUC: ABCDEFGHIJKLMNOPQRSTUVWXYZ</p> <p>AlphaNumLC: abcdefghijklmnopqrstuvwxyz</p> <p>AlphaNumSP: space!"#\$%&'()*+,-./:;<=>?@[]^_`{ }~</p> <p>NumericCust: Anything in the Numeric set. See table below.</p> <p>AlphaNumCust: Anything in the Alpha-numeric set. See table below.</p>

POCSAG Message Encoding Tables

POCSAG Numeric Character Set	
Binary	Character
0000	0
0001	1
0010	2
0011	3
0100	4
0101	5
0110	6
0111	7
1000	8
1001	9
1010	Spare (not available)
1011	U
1100	-
1110	[
1111]

POCSAG Alphanumeric Character Set (7-bit ASCII)								
Decimal	Binary	Character	Decimal	Binary	Character	Decimal	Binary	Character
20	0100000	SPACE	52	1000000	@	84	1100000	`
21	0100001	!	53	1000001	A	85	1100001	a
22	0100010	“	54	1000010	B	86	1100010	b
23	0100011	#	55	1000011	C	87	1100011	c
24	0100100	\$	56	1000100	D	88	1100100	d
25	0100101	%	57	1000101	E	89	1100101	e
26	0100110	&	58	1000110	F	90	1100110	f
27	0100111	‘	59	1000111	G	91	1100111	g
28	0101000	(60	1001000	H	92	1101000	h
29	0101001)	61	1001001	I	93	1101001	i
30	0101010	*	62	1001010	J	94	1101010	j

POCSAG Alphanumeric Character Set (7-bit ASCII)								
Decimal	Binary	Character	Decimal	Binary	Character	Decimal	Binary	Character
31	0101011	+	63	1001011	K	95	1101011	k
32	0101100	,	64	1001100	L	96	1101100	l
33	0101101	-	65	1001101	M	97	1101101	m
34	0101110	.	66	1001110	N	98	1101110	n
35	0101111	/	67	1001111	O	99	1101111	o
36	0110000	0	68	1010000	P	100	1110000	p
37	0110001	1	69	1010001	Q	101	1110001	q
38	0110010	2	70	1010010	R	102	1110010	r
39	0110011	3	71	1010011	S	103	1110011	s
40	0110100	4	72	1010100	T	104	1110100	t
41	0110101	5	73	1010101	U	105	1110101	u
42	0110110	6	74	1010110	V	106	1110110	v
43	0110111	7	75	1010111	W	107	1110111	w
44	0111000	8	76	1011000	X	108	1111000	x
45	0111001	9	77	1011001	Y	109	1111001	y
46	0111010	:	78	1011010	Z	110	1111010	z
47	0111011	;	79	1011011	[111	1111011	{
48	0111100	<	80	1011100	\	112	1111100	
49	0111101	=	81	1011101]	113	1111101	}
50	0111110	>	82	1011110	^	114	1111110	~
51	0111111	?	83	1011111	_	115	1111111	N/A

Message Length

When the audio synthesizer format is set to POCSAG, pressing this key activates the Message Length input dialog where you can set the message length from 0 to 60 characters.

Range	0 to 60
Default	16
Saved State	Saved with instrument state

Data Rate

When the audio synthesizer format is set to POCSAG, pressing this key activates the Data Rate input dialog where you can set the communication data rate.

Range	400 to 4800 bps
Default	1200 bps
Saved State	Saved with instrument state

Polarity

When the audio synthesizer format is set to POCSAG, pressing this soft key activates a horizontal soft key menu where you can select the POCSAG datastream polarity.

Discrete Values	Normal, Inverted
Default	Normal
Saved State	Saved with instrument state
Notes	When set to Normal, a logic high (1) results in a more positive frequency deviation in FM mode. A logic low (0) results in a more negative frequency deviation in FM mode. When set to Inverted, a logic high (1) results in more negative frequency deviation in FM mode. A logic low (0) results in a more positive frequency deviation in FM mode.

Error Bit

When the audio synthesizer format is set to POCSAG, pressing this key activates the Error Bit input dialog to set the error bit at the specified location in the POCSAG page bit stream.

Range	0 to 2200
Default	1200
Saved State	Saved with instrument state
Notes	The error bit allows targeted insertion of an error into the page to test a POCSAG decoder's error correction capability. The setting toggles the Error Bit in the POCSAG page bit stream, where the bit stream uses a 1-based index. If Error Bit is set to 0 (default), no bits are toggled. If Error Bit is set ≥ 1 , then the bit stream (Error Bit) is toggled.

General Sequence Synthesizer Format Soft Keys

The following soft keys are unique to the General Sequence audio synthesizer format.

Code Sequence

When the audio synthesizer format is set to General Sequence, pressing this key activates the Code Sequence dialog and a horizontal menu for entering an audio tone sequence for encoding on either the RF carrier or Mod Out port.

Pressing **Clear to End** in the horizontal menu clears the highlighted entry and all others to the right.

Discrete Values	0, 1, 2, 3, 4, 5, 6, 7, 8, 9, A, B, C, D, E, F, G, H, I, J
Default	0123456789ABCDEFGHIJ
Saved State	Saved with instrument state
Notes	Each entry can be one of 20 Tone Codes (0 to 9 and A to J) with the frequency, duration, and post tone delay specified in the General Sequence Table.

General Sequence Table

When the audio synthesizer format is set to General Sequence, pressing this soft key displays the General Sequence Table where you can enter create custom codes for use in sequences.

Notes	The table is populated with 20 Tone Codes (0 to 9 and A to J) with preset data for frequency, duration, and post-tone delay. The selected Tone Standard determines the preset data for each tone code. Regardless of the standard selected, each Tone Code can be edited for the current operating session or saved as a customized sequence.
-------	---

Select Tone Standard

When the audio synthesizer format is set to General Sequence, pressing this key activates the Select Tone Standard dialog where you can select which standard is used for the preset Tone Code entries on the General Sequence table.

Discrete Values	None, CCIR1, CCIR2, PCCIR, CCITT, EEA, EIA, Euro, NATEL, MODAT, ZVEI1, ZVEI2, ZVEI3, DZVEI, PDZVEI
Default	None
Saved State	Saved with instrument state
Notes	Edited tables can be saved as a user-defined Sequence Definition. Reselecting and entering any Tone Standard restores the original table entries.

Synth Mode

When the audio synthesizer format is set to General Sequence, pressing this soft key activates a horizontal soft key menu where you can select the synthesized audio generator operating state.

Discrete Values	Off, Continuous, Burst
Default	Off
Saved State	Saved with instrument state
Notes	The status of the Synth Mode is shown in the Mode field.

Tone Frequency

When the audio synthesizer format is set to General Sequence, use the arrow keys to highlight a Tone Code to edit with the blue selection arrow, then press this soft key to activate a data entry window for customizing the Tone Frequency of the highlighted Tone Code.

Range	0 to 20000 Hz
Default	0 Hz
Saved State	Saved with instrument state

Tone Duration

When the audio synthesizer format is set to General Sequence, use the arrow keys to highlight a Tone Code to edit with the blue selection arrow, then press this soft key to activate a Tone duration dialog where you can enter a duration for a highlighted code duration.

Range	0 to 10 s
Default	0 s
Saved State	Saved with instrument state

Post-Tone Delay

When the audio synthesizer format is set to General Sequence, use the arrow keys to highlight a Tone Code to edit with the blue selection arrow, then press this soft key to activate a Post-Tone Delay dialog, where you can enter a duration of the delay following the transmitted tone.

Range	0 to 10 s
Default	0 s
Saved State	Saved with instrument state

Save Sequence Definition

When the audio synthesizer format is set to General Sequence, pressing this soft key activates the Save Sequence Definition dialog, where you can enter an alphanumeric filename for saving the sequence definition.

Range	A to Z and 0 to 9
Default	MY
Saved State	Saved with instrument state

Load Sequence Definition

When the audio synthesizer format is set to General Sequence, pressing this soft key activates a Load Sequence Definition dialog, where you can load a sequence definition.

Notes	Must have a saved sequence definition to activate this soft key.
-------	--

Export Sequence Definition

When the audio synthesizer format is set to General Sequence, pressing this soft key activates an Export Sequence Definition dialog, where you can select a sequence definition to save on an external USB.

Notes	Must have a saved sequence definition to activate this soft key.
-------	--

Delete Sequence Definition

When the audio synthesizer format is set to General Sequence, pressing this soft key activates a Delete Sequence Definition dialog, where you can delete a sequence definition.

Notes	Must have a saved sequence definition to activate this soft key.
-------	--

Sync to Code Entry

When the audio synthesizer format is set to General Sequence, pressing this soft key activates a Sync to Code Entry dialog, where you can select the status of code synchronization.

Discrete Values	No, Yes
Default	Yes
Saved State	Saved with instrument state
Notes	Yes – Any Tone Code alphanumeric value entered into the Code Sequence field is initially populated into the associated position in the Duration and Delay Sequence fields. This matches the frequency, duration, and delay values for each tone in the Code Sequence to that shown on the Tone Code line entry in the table. If desired, these initially synchronized Duration and Delay

	<p>sequence entries can be changed to other values from the table.</p> <p>No – The entries for the Duration and Delay Sequences are set independently of the Code Sequence, with duration and delay values from any Tone Code on the table.</p>
--	---

Duration Sequence

When the audio synthesizer format is set to General Sequence, pressing this soft key activates a Duration Sequence dialog, where you can enter a custom duration sequence as well as a horizontal soft key menu where you can clear the current Duration Sequence entry.

Discrete Values	0, 1, 2, 3, 4, 5, 6, 7, 8, 9, A, B, C, D, E, F, G, H, I, J
Default	0123456789ABCDEFGHIJ
Saved State	Saved with instrument state
Notes	<p>Clear to End – clears the highlighted entry and all others to the right.</p> <p>Each entry in the Duration Sequence is paired in positional order with the associated entry in the Code Sequence, which provides the tone frequency, and the Delay Sequence, which provides the post tone delay. A duration of zero is used for Code Sequence entries that do not have an associated Duration Sequence entry. Duration Sequence entries that do not have an associated Code Sequence entry are ignored</p>

Delay Sequence

When the audio synthesizer format is set to General Sequence, pressing this soft key activates a Delay Sequence dialog, where you can enter a custom duration sequence, as well as activates a horizontal soft key menu where you can clear the current Delay Sequence entry.

Discrete Values	0, 1, 2, 3, 4, 5, 6, 7, 8, 9, A, B, C, D, E, F, G, H, I, J
Default	0123456789ABCDEFGHIJ
Saved State	Saved with instrument state
Notes	<p>Clear to End – clears the highlighted entry and all others to the right.</p> <p>Each entry in the Delay Sequence is paired in positional order with the associated entry in the Code Sequence, which provides the tone frequency, and the Duration Sequence, which provides the tone duration. A delay of zero is used for Code Sequence entries that do not have an associated Delay Sequence entry. Delay Sequence entries that do not have an associated Code Sequence entry are ignored.</p>

DISPLAY Zone Soft Keys for Duplex Mode

In Monitor Mode, the DISPLAY Zone represents the controls for the primary graticule measurement display or bar graphs. Use these soft keys to configure your desired display.

Select Display (DISPLAY Zone menu)

Pressing this soft key activates a horizontal soft key menu where you can select the display mode.

Discrete Values	Spec An, Mod Scope, Oscilloscope, Bar Graphs
Default	Spec An
Saved State	Saved with instrument state

Center Frequency (Spectrum Analyzer submenu)

When display is set to Spec An, pressing this soft key displays the Center Frequency dialog where you can enter the desired value to set the center frequency on the receiver display.

Range	250 kHz to 3.0 GHz
Default	500 MHz
Saved State	Saved with instrument state

Span (Spectrum Analyzer submenu)

When display is set to Spec An, pressing this soft key displays the Span dialog where you can input the desired frequency span for the receiver.

Range	10 kHz to 20 MHz
Default	10 MHz
Saved State	Saved with instrument state
Notes	<p>Frequency span allows you to zoom in or out (change the span of the X-axis) on a signal of interest, while maintaining the relative power (Y-axis). To zoom in on a signal, decrease the frequency span while maintaining the signal at center frequency. To zoom out, increase the frequency span. The value entered for Span is automatically split between each side of the current center frequency.</p> <p>Receiver modulated audio is inhibited at spans above 158 kHz. Switch display to Mod Scope or use Demod at Marker function to hear audio at wider spans.</p>

Start Frequency (Spectrum Analyzer submenu)

When display is set to Spec An, pressing this soft key displays the Start Frequency dialog where you can input the lowest frequency currently measured and shown on the receiver display.

Range	250 kHz to 1.5 GHz
Default	495 MHz
Saved State	Saved with instrument state
Notes	The analyzer automatically centers the frequency display midway between Start and Stop frequencies.
Couplings	When adjusting the start frequency the stop frequency is held constant, meaning that both the center frequency and span will change.

Stop Frequency (Spectrum Analyzer submenu)

When display is set to Spec An, pressing this soft key displays the Stop Frequency dialog where you can input the highest frequency currently measured and shown on the receiver display.

Range	260 kHz to 3 GHz
Default	1 MHz
Saved State	Saved with instrument state
Notes	The analyzer automatically centers the frequency display midway between Start and Stop frequencies.
Couplings	When adjusting the stop frequency the start frequency is held constant, meaning that both the center frequency and span will change.

Reference Level (Spectrum Analyzer submenu)

When display is set to Spec An, pressing this soft key displays the Reference Level dialog where you can input the value of the top graticule line.

Range	0 to 90 dBm
Default	0 dBm
Saved State	Saved with instrument state

Vertical Scale (Spectrum Analyzer submenu)

When the display is set to Spec An, pressing this soft key activates a horizontal soft key menu where you can select the Y-axis scale.

Discrete Values	10 dB/div, 5 dB/div, 2 dB/div, 1 dB/div
Default	10 dB/div
Saved State	Saved with instrument state

Display Mode (Spectrum Analyzer submenu)

When the display is set to Spec An, pressing this soft key activates a horizontal soft key menu where you can select the trace graphing mode.

Discrete Values	Normal, Freeze, Max Hold, Average
-----------------	-----------------------------------

Default	Normal
Saved State	Saved with instrument state
Notes	<p>Normal – The display updates continuously.</p> <p>Freeze – The display provides a snapshot of the current display indication and stops additional updates. In Freeze Mode, the R8200 reacquires data and updates the display whenever Center Marker or Center Peak is pressed.</p> <p>Max Hold – The display retains the highest peak signal amplitudes measured during successive sweeps.</p> <p>Average – The displayed signal amplitudes are a rolling average of the peak amplitudes measured on each successive sweep. The average consists of one to five sweeps, shown beside the mode indication.</p>

Trace Math (Spectrum Analyzer submenu)

When the display is set to Spec An, pressing this soft key activates a horizontal soft key menu where you can select the trace math to be applied.

Discrete Values	None, Spec-Ref (log), ISpec-Ref1 (lin), Spec+Ref (lin)
Default	None
Saved State	Saved with instrument state
Notes	<p>The underlying units of the result are no longer dBm but dB for the displayed spectrum and thus marker power.</p> <p>None – This selection hides the reference trace and displays the spectrum resulting from the Display Mode unmodified.</p>

	<p>Spec-Ref (log) – This selection displays the difference of the Display Mode spectrum in dBm minus the reference trace in dBm, which normalizes the spectrum to 0 on the Y-axis. Subsequently, spectrum power is shown on the display and measured by absolute markers relative to the reference trace, i.e., correctly interpreted as dBm above the reference.</p> <p>ISpec-Refl (lin) – This choice displays the logarithm of the absolute value of the difference of the Display Mode spectrum in volts² minus the reference trace in volts². Although the absolute value of the difference avoids logarithm of negatives, it has the side effect of increasing the apparent noise power.</p> <p>Spec+Ref (lin) – This choice displays the logarithm of the sum of the Display Mode spectrum in volts² plus the reference trace in volts².</p>
--	---

Set Reference Trace (Spectrum Analyzer submenu)

When the display is set to Spec An, pressing this soft key saves the current trace as a separate blue reference trace.

Notes	<p>The trace is copied from what is currently shown, which is after any Display Mode processing as well as Trace Math computations. Therefore, ensure that both of those settings are appropriately set (i.e., Trace Math is None); setting the reference when Trace Math is active may yield incoherent results. Setting Display Mode to Average minimizes effects of a low level / high variance signal such as the noise floor. This static trace is used for computations when a Trace Math equation is specified and may simply be viewed even when one is not. It can be hidden by selecting Trace Math None.</p> <p>System changes that may invalidate the reference trace include port, amplification, attenuation, frequency, span, temperature, and calibration.</p>
-------	--

Detector (Spectrum Analyzer submenu)

When the display is set to Spec An, pressing this soft key activates a horizontal soft key menu where you can select the Detector mode.

Discrete Values	Power, Peak, Sample, Mean, Valley
Default	Peak
Saved State	Saved with instrument state

3 dB Marker (Spectrum Analyzer submenu)

When the display is set to Spectrum Analyzer, pressing this soft key activates a horizontal soft key menu where you can select the 3 dB Marker mode.

Discrete Values	Off, Frequency, Delta
Default	Off
Saved State	Saved with instrument state
Notes	<p>Off – Deactivates markers.</p> <p>Frequency – This selection places a marker above and below center frequency where the signal is –3 dB below the peak amplitude measured at center frequency. The upper and lower frequencies are shown on the display.</p> <p>Delta – This selection places a marker above and below center frequency where the signal is –3 dB below the peak amplitude measured at center frequency. The difference between these two frequencies is shown on the display.</p>

Marker Mode (Spectrum Analyzer submenu)

When the display is set to Spec An, pressing this soft key activates a horizontal soft key menu where you can select the Marker Mode.

Discrete Values	Off, Absolute, Delta
Default	Off
Saved State	Saved with instrument state
Notes	<p>Off – Deactivates markers.</p> <p>Absolute – This selection displays the frequency and absolute signal amplitude for each marker selected.</p> <p>Delta – This selection displays the frequency and amplitude difference between each pair of markers selected.</p> <p>Depending on the installed options, up to four markers can be enabled and selected for positioning while in Instrument Mode.</p>

Toggle Marker (Spectrum Analyzer submenu)

When the display is set to Spec An, cycles through the available markers to select a marker for repositioning along the trace.

Center Marker (Spectrum Analyzer submenu)

When the display is set to Spec An, pressing this soft key moves the active marker to the middle of the spectrum.

Find Peak (Spectrum Analyzer submenu)

When the display is set to Spec An, pressing this soft key moves the active marker to highest trace peak.

Center Peak (Spectrum Analyzer submenu)

When the display is set to Spec An, pressing this soft key centers the display around the highest peak.

Demod at Marker (Spectrum Analyzer submenu)

When the display is set to Spec An and Marker Mode is set to absolute, pressing this soft key activates a horizontal soft key menu where you can select the demodulation mode at the active marker.

Discrete Values	Off, Single, Continuous
Default	Off
Saved State	Saved with instrument state
Notes	<p>Off – Demod is deactivated.</p> <p>Single – This selection provides a one-time demodulation of the carrier signal located at the marker position for a quick listen at the marker frequency. Moving the marker or changing the monitor frequency, mode, or DISPLAY Zone selection switches the Demod At Marker function Off.</p> <p>Continuous – Continuous Mode allows users to move the selected marker to demodulate carriers across the entire displayed spectrum. On full-screen instruments, the user can setup several markers on various peaks and use the marker selection to quickly demodulate and listen to those peaks. Additionally, on the Dual Display, the user can simultaneously view the Modulation Scope while tuning the marker positions.</p> <p>To ensure audio is demodulated, the marker must be close enough to overlap the analyzer Monitor Bandwidth around the carrier frequency. Large Span settings increase marker frequency step size, limiting how close the marker can get to the actual frequency. To minimize step size, use the narrowest span practical when displaying multiple carriers.</p>

Vertical Scale (Modulation Scope submenu)

When display is set to Mod Scope, pressing this soft key activates a horizontal soft key menu where you can select the vertical scale.

Discrete Values	100, 200, 500 Hz and 1, 2, 5, 10, 20, 50 kHz/Div
Default	1 kHz/Div
Saved State	Saved with instrument state

Horizontal Scale (Modulation Scope submenu)

When display is set to Mod Scope, pressing this softkey displays the Horizontal Scale input dialog where you can select the horizontal scale.

Discrete Values	20, 50, 100, 200, 500 μ s and 1, 2, 5, 10, 20, 50, 100, 200, 500 ms and 1 s
Default	20 ms
Saved State	Saved with instrument state

Marker Mode (Modulation Scope submenu)

When display is set to Mod Scope, pressing this soft key activates a horizontal soft key menu where you can select the Marker Mode.

Discrete Values	Off, Delta V, Delta T, 1/Delta T
Default	Off
Saved State	Saved with instrument state
Notes	Off – Deactivates markers.

	<p>Delta V – The numeric reading shows the difference in amplitude between marker positions.</p> <p>Delta T – The numeric reading shows the difference in time between marker positions.</p> <p>1/DeltaT – The numeric reading shows the inverse of the time difference between markers, which can be used to determine the frequency of a repetitive waveform.</p> <p>Depending on the installed options, up to four markers can be enabled and selected for positioning while in Instrument Mode.</p>
--	---

Toggle Marker (Modulation Scope submenu)

When the display is set to Mod Scope, pressing this soft key cycles through the available markers to activate one for repositioning (active markers are yellow).

Trigger Mode (Modulation Scope submenu)

When display is set to Mod Scope, pressing this soft key activates a horizontal soft key menu where you can select the Modulation Scope Trigger type.

Discrete Values	Auto, Normal, Single
Default	Auto
Saved State	Saved with instrument state
Notes	<p>Auto – If a signal satisfying the Trigger Edge and Trigger Level settings is present, the display will sweep as in Normal Mode. If no signal satisfying the Trigger Edge and Trigger Level settings is present, then the display sweeps continuously until a signal satisfying the settings is acquired.</p> <p>Normal – The display sweeps only when the input signal satisfies the Trigger Edge and Trigger Level settings.</p> <p>Single – The display sweeps once after a key press is performed on the Single soft key if the signal satisfies the Trigger Edge and Trigger level settings.</p>

Trigger Level (Modulation Scope submenu)

When display is set to Mod Scope, pressing this soft key activates a Trigger Level dialog where you can enter the trigger threshold level in kHz.

Range	-200 to 200 kHz
Default	0 kHz
Saved State	Saved with instrument state

Trigger Edge (Modulation Scope submenu)

When display is set to Mod Scope, pressing this soft key activates a horizontal soft key menu where you can select the Modulation Scope trigger type.

Discrete Values	Rising, Falling, Either
Default	Rising
Saved State	Saved with instrument state

Vertical Position (Modulation Scope submenu)

When display is set to Mod Scope, pressing this soft key activates a horizontal soft key menu where you can adjust the Modulation Scope vertical position up or down.

Discrete Values	Move Down, Move Up
Default	Move Down
Saved State	Saved with instrument state

Coupling (Oscilloscope submenu)

When display is set to Oscilloscope, pressing this soft key activates a Coupling dialog menu where you can select the input voltage coupling.

Discrete Values	DC, AC
Default	DC
Saved State	Saved with instrument state

Horizontal Scale (Oscilloscope submenu)

When display is set to Oscilloscope, pressing this softkey displays the Horizontal Scale input dialog where you can select the horizontal scale.

Discrete Values	20, 50, 100, 200, 500 μ s and 1, 2, 5, 10, 20, 50, 100, 200, 500 ms and 1 s						
Default	1 ms						
Saved State	Saved with instrument state						
Notes	Digital Oscilloscopes are susceptible to aliasing, which can cause inaccurate signal reconstruction. The Maximum recommended input frequency for each horizontal scale setting is shown in the display area. For best results, follow the guidelines shown in the table below. <table border="1"><thead><tr><th>Horizontal Scale</th><th>Max Signal Frequency</th><th>Max Recommended Signal Frequency</th></tr></thead><tbody><tr><td>20 μs</td><td>50000 Hz</td><td>50000 Hz</td></tr></tbody></table>	Horizontal Scale	Max Signal Frequency	Max Recommended Signal Frequency	20 μ s	50000 Hz	50000 Hz
Horizontal Scale	Max Signal Frequency	Max Recommended Signal Frequency					
20 μ s	50000 Hz	50000 Hz					

	Horizontal Scale	Max Signal Frequency	Max Recommended Signal Frequency
	50 μ s	50000 Hz	20000 Hz
	100 μ s	50000 Hz	10000 Hz
	200 μ s	25000 Hz	5000 Hz
	500 μ s	10000 Hz	2000 Hz
	1 ms	5000 Hz	1000 Hz
	2 ms	2500 Hz	500 Hz
	5 ms	1000 Hz	200 Hz
	10 ms	500 Hz	100 Hz
	20 ms	250 Hz	50 Hz
	50 ms	100 Hz	20 Hz
	100 ms	50 Hz	10 Hz
	200 ms	25 Hz	5 Hz
	500 ms	10 Hz	2 Hz
	1 s	5 Hz	1 Hz

Vertical Scale (Oscilloscope submenu)

When display is set to Oscilloscope, pressing this softkey displays the Vertical Scale input dialog where you can select the vertical scale.

Discrete Values	50, 100, 200, 500 mV and 1, 2, 5, 10, 15, 20, 25 V
Default	1 V
Saved State	Saved with instrument state

Marker Mode (Oscilloscope submenu)

When display is set to Oscilloscope, pressing this soft key activates a horizontal soft key menu where you can select the select the Marker Mode.

Discrete Values	Off, Delta V, Delta T, 1/Delta T
Default	Off
Saved State	Saved with instrument state
Notes	Off – Deactivates markers. Delta V – The numeric reading shows the difference in amplitude between marker positions. Delta T – The numeric reading shows the difference in time between marker positions. 1/Delta T – The numeric reading shows the inverse of the time difference between markers, which can be used to determine the frequency of a repetitive waveform. Depending on the installed options, up to four markers can be enabled and selected for positioning while in Instrument Mode.

Toggle Marker (Oscilloscope submenu)

When the display is set to Oscilloscope, pressing this soft key switches between Marker 1 and 2.

Trigger Mode (Oscilloscope submenu)

When display is set to Oscilloscope, pressing this soft key activates a horizontal soft key menu where you can select the Oscilloscope Trigger Mode.

Discrete	Auto, Normal, Single
----------	----------------------

Values	
Default	Auto
Saved State	Saved with instrument state
Notes	<p>Auto – If a signal satisfying the Trigger Edge and Trigger Level settings is present, the display will sweep as in Normal Mode. If no signal satisfying the Trigger Edge and Trigger Level settings is present, then the display sweeps continuously until a signal satisfying the settings is acquired.</p> <p>Normal – The display sweeps only when the input signal satisfies the Trigger Edge and Trigger Level settings.</p> <p>Single – The display sweeps once after a key press is performed on the Single soft key if the signal satisfies the Trigger Edge and Trigger level settings.</p>

Trigger Level (Oscilloscope submenu)

When display is set to Oscilloscope, pressing this soft key activates a Trigger Level dialog where you can enter the trigger threshold level.

Range	–100 to 100
Default	0
Saved State	Saved with instrument state

Trigger Position (Oscilloscope submenu)

When display is set to Oscilloscope, pressing this soft key activates a Trigger Level dialog where you can enter the trigger threshold level.

Discrete Values	10%, 50%, 90%
Default	50%
Saved State	Saved with instrument state

Trigger Edge (Oscilloscope submenu)

When display is set to Oscilloscope, pressing this soft key activates a horizontal soft key menu where you can select the Oscilloscope trigger type.

Discrete Values	Rising, Falling, Either
Default	Rising
Saved State	Saved with instrument state

Vertical Position (Oscilloscope submenu)

When display is set to Oscilloscope, pressing this soft key activates a horizontal soft key menu where you can adjust the Oscilloscope up or down.

Discrete Values	Move Down, Move Up
Default	Move Down
Saved State	Saved with instrument state

Set DC Offset (Oscilloscope submenu)

When display is set to Oscilloscope, pressing this soft key zeroes out the Oscilloscope to account for a DC offset.

Notes	With the Meter In port disconnected, press the soft key to eliminate the offset. The compensation is stored permanently in the analyzer until the next time this soft key is pressed.
-------	---

Deviation Average (Bar Graphs submenu)

When display is set to Bar Graphs, pressing this soft key activates a horizontal soft key menu where select Deviation Average settings to process the response settings.

Discrete Values	Normal, Peak Average, Pwr-Weight Average, RMS Average, \pm Peak/2
Default	Normal
Saved State	Saved with instrument state
Notes	<p>Normal – No smoothing is engaged, which provides the quickest measurement response.</p> <p>Peak Average – The deviation peaks are averaged over a time window, which smooths the reading but slows the response.</p> <p>Pwr-Weight Average – The deviation measurement is processed with an RMS converter, but the display calibration remains in peak units (i.e., a deviation of 3 kHz pk will read 3 kHz on the numeric readout and bar graph). This type of processing significantly reduces the effect of narrow deviation spikes and noise while providing a speed of response similar to the normal mode.</p> <p>Scale calibration and the peak readings are only valid for single tone repetitive sine wave modulation. For the RMS value of any modulation waveform, divide the displayed peak reading by 1.414.</p>

	<p>RMS Average – The deviation measurement is the square root of the mean of the squares of the deviation values. This type of processing significantly reduces the effect of narrow deviation spikes and noise while providing a speed of response similar to the normal mode.</p> <p>Scale calibration and the RMS readings are valid for any wave modulation (e.g., sawtooth).</p>
--	---

METER Zone Soft Keys for Duplex Mode

In Duplex Mode, the METER Zone displays the controls for configuring supplementary metering devices. Use these soft keys to apply general purpose and specialized instruments providing detailed analysis of both the RF carrier and its recovered baseband content.

Select Meter (METER Zone menu)

Activates a horizontal soft key menu where you can select the metering device.

Discrete Values	Power Meter, Voltmeter, SINAD/Distortion, Decoder, Frequency Counter, RF Scan, SNRMeter
Default	Power Meter
Saved State	Saved with instrument state
Notes	RF Scan is not available in Generate Mode.

Power Meter (METER Zone menu)

Opens the Power Meter display and submenu.

Range (Power Meter submenu)

When the meter is set to Power Meter, pressing this soft key activates a horizontal soft key menu where you can select the power meter range.

Discrete Values	5, 10, 50, 150 W
Default	50 W
Saved State	Saved with instrument state
Notes	For best accuracy, disable the Pre-amplifier in Monitor Mode and set the Gen Port in Generate Mode to RF In/Out.

Voltmeter (METER Zone menu)

Opens the Voltmeter display and submenu.

Select Voltmeter Mode (Voltmeter submenu)

When the meter is set to Voltmeter, pressing this soft key activates a horizontal soft key menu where you can select the voltage mode for the Voltmeter.

Discrete Values	AC Volts, DC Volts
Default	AC Volts
Saved State	Saved with instrument state
Notes	AC Volts measures AC voltage applied to the Meter In port. The dBm computation assumes an impedance of 600Ω.

Coupling (Voltmeter submenu)

When the meter is set to Voltmeter, pressing this soft key activates a Coupling dialog menu where you can select the input voltage coupling.

Discrete Values	DC, AC
Default	DC
Saved State	Saved with instrument state

AC Range (Voltmeter submenu)

When the meter is set to Voltmeter, pressing this soft key activates a horizontal soft key menu where you can select the power meter AC voltage range.

Discrete Values	Auto, 1 V, 10 V, 70 V
Default	Auto
Saved State	Saved with instrument state
Notes	The range on AC and DC must be 1 or 10 Volts to use 600 Ohm Input Impedance.

Set dBr Reference (Voltmeter submenu)

When the meter is set to Voltmeter and Voltmeter mode is set to AC, pressing this soft key sets a reference input voltage.

Notes	When selected, dBm measurements are frozen, and a dBr indicator appears. The dBr indicates the normalized measurement between the reference input voltage and the current input voltage.
-------	--

Clear dBr Reference (Voltmeter submenu)

When the meter is set to Voltmeter and Voltmeter mode is set to AC, pressing this soft key clears the dBr reference input voltage.

Voltage Units (Voltmeter submenu)

When the meter is set to Voltmeter, pressing this soft key activates a horizontal soft key menu where you can select the power meter range.

Discrete Values	Volts (V), Millivolts (mV), Decibel Volts (dBV)
Default	Volts (V)
Saved State	Saved with instrument state

DC Range (Voltmeter submenu)

When the meter is set to Voltmeter, pressing this soft key activates a horizontal soft key menu where you can select the power meter DC voltage range.

Discrete Values	Auto, 1 V, 10 V, 70 V
Default	Auto
Saved State	Saved with instrument state
Notes	The range on AC and DC must be 1 or 10 Volts to use 600 Ohm Input Impedance.

SINAD/Distortion (METER Zone menu)

Opens the SINAD/Distortion display and submenu.

Select Audio Measurement (SINAD/Distortion submenu)

When the meter is set to SINAD/Ext Distortion, pressing this soft key activates a horizontal soft key menu where you can select the distortion source.

Discrete Values	SINAD/Ext Distortion, Internal Distortion
Default	SINAD/Ext Distortion
Saved State	Saved with instrument state

Decoder (METER Zone menu)

Opens the Decoder display and submenu.

Select Decoder Type (Decoder submenu)

When the meter is set to Decoder, pressing this soft key activates a horizontal soft key menu where you can select the decoder type.

Discrete Values	PL/Period Counter, DPL Decode, DTMF Decode, 2-Tone Decode, 5/6 Tone Decode, General Sequence
Default	PL/Period Counter
Saved State	Saved with instrument state

Reset (Decoder submenu)

When the meter is set to Decoder and Decoder Type is set to DTMF Decode, pressing this soft key resets the decoder.

Decode (Decoder submenu)

When the meter is set to Decoder, pressing this soft key activates a horizontal soft key menu where you can select start and stop the decoding.

Discrete Values	Stop, Start
Default	Stop
Saved State	Saved with instrument state
Notes	This function is available one for the 2-Tone Decode, 5/6 Tone Decode, General Sequence decoder types.

Decode to Standard (Decoder submenu)

When the meter is set to Decoder, pressing this soft key activates a horizontal soft key menu where you can select the decoding standard to be used.

Discrete Values	None, CCIR1, CCIR2, PCCIR, CCITT, EEA, EIA, Euro, NATEL, MODAT, ZVEI1, ZVEI2, ZVEI3, PZVEI, DZVEI, PDZVEI
Default	None
Saved State	Saved with instrument state
Notes	This function is available one for the General Sequence decoder type.

Low Pass Filter (Decoder submenu)

When the meter is set to Decoder, pressing this soft key activates a horizontal soft key menu where you can select the high pass frequency.

Discrete Values	300 Hz, 3 kHz, 20 kHz
Default	300 Hz
Saved State	Saved with instrument state

High Pass Filter (Decoder submenu)

When the meter is set to Decoder, pressing this soft key activates a horizontal soft key menu where you can select the high pass frequency.

Discrete Values	1 Hz, 300 Hz, 3 kHz
Default	1 Hz
Saved State	Saved with instrument state

Input Decoding (Decoder submenu)

When the meter is set to Decoder, pressing this soft key displays a Input Decoding dialog menu where you can select which decoding source to use.

Discrete Values	Internal, External
Default	Internal
Saved State	Saved with instrument state

Frequency Counter (METER Zone menu)

Opens the Frequency Counter display and submenu.

Reset (Frequency Counter submenu)

When the meter is set to Frequency Counter, pressing this soft key resets the frequency counter.

Input Decoding (Frequency Counter submenu)

When the meter is set to Frequency Counter, pressing this soft key displays a Input Decoding dialog menu where you can select which decoding source to use.

Discrete Values	Internal, External
Default	Internal
Saved State	Saved with instrument state

Resolution (Frequency Counter submenu)

When the meter is set to Frequency Counter, pressing this soft key activates a horizontal soft key menu where you can select the frequency counter resolution.

Discrete Values	0.001 Hz, 0.01 Hz, 0.1 Hz, 1.0 Hz, 10 Hz
Default	1.0 Hz
Saved State	Saved with instrument state

RF Scan (METER Zone menu)

Opens the RF Scan display and submenu.

Start Frequency (RF Scan submenu)

When the meter is set to RF Scan, pressing this key displays the Start Frequency dialog where you can input the start frequency to be used in the RF scan.

Range	1 to 2991 MHz
Default	400 MHz
Saved State	Saved with instrument state

Stop Frequency (RF Scan submenu)

When the meter is set to RF Scan, pressing this key displays the Stop Frequency dialog where you can input the start frequency to be used in the RF scan.

Range	1 to 2991 MHz
Default	600 MHz
Saved State	Saved with instrument state

Scan (RF Scan submenu)

When the meter is set to RF Scan, pressing this soft key activates a horizontal soft key menu where you can select the scanning mode.

Discrete Values	Off, Single, Auto
Default	Off

Saved State	Saved with instrument state
Notes	<p>Off – Deactivates scanning.</p> <p>Single – Sweep the span defined by the Start and Stop Frequency parameters once.</p> <p>Auto – Continuously sweeps the span defined by the Start and Stop Frequency parameters.</p> <p>The signal captured by the scan will automatically set the Monitor Frequency to the closest channel in the selected RF Bandwidth. For example, if the signal captured by the receiver in a 12.5 kHz BW is 390.011911 kHz, then the Monitor Frequency will be set to 390.0125 (i.e., the ideal channel frequency). This ensures that the Frequency Error meter will display the offset from this ideal.</p>

SNR (METER Zone menu)

Opens the Signal-to-Noise Ratio display.

11 Instrument Mode Soft Keys

The Instrument Mode menu enables access to standard and optional full-screen analyzers, scopes, and meters. This chapter contains detailed descriptions of the soft keys accessible in each instrument. Each soft key is defined, along with its range, discrete, default, and saved state values.

The sections are organized as the instruments appear in the display user interface:

"Spectrum Analyzer Soft Keys" on the next page describes the adjustable parameters for spectrum analysis.

"Modulation Scope Soft Keys" on page 535 describes the adjustable parameters for time-based modulation analysis.

"Oscilloscope Soft Keys" on page 539 describes the adjustable parameters for time-based analysis.

"Dual Display Soft Keys" on page 544 describes the adjustable parameters for spectrum and time-based modulation analysis.

"Tracking Generator Soft Keys" on page 557 describes the adjustable parameters for scalar network analysis.

"Cable Fault Locator Soft Keys" on page 567 describes the adjustable parameters for scalar network analysis of cables.

"Single-Port VNA Soft Keys" on page 576 describes the adjustable parameters for single-port vector network analysis.

"METER Zone Soft Keys for Monitor Mode" on page 401 describes the adjustable parameters for metering.

Spectrum Analyzer Soft Keys

In the Spectrum Analyzer Instrument Mode, the R8200 operates as a stand-alone full-screen instrument capable of signal analysis between 250 kHz to 3 GHz. Use the following soft keys to configure your measurement.

Center Frequency (Spectrum Analyzer submenu)

Enables the Center Frequency dialog where you can set the center frequency for the receiver display.

Range	250 kHz to 3.0 GHz
Default	500 MHz
Saved State	Saved with instrument state

Span (Spectrum Analyzer submenu)

Displays the Span dialog where you can input the desired frequency span for the receiver.

Range	10 kHz to 20 MHz
Default	10 MHz
Saved State	Saved with instrument state
Notes	Frequency span allows you to zoom in or out (change the span of the X-axis) on a signal of interest, while maintaining the relative power (Y-axis). To zoom in on a signal, decrease the frequency span while maintaining the signal at center frequency. To zoom out, increase the frequency span. The value entered for Span is automatically split between each side of the current center fre-

	<p>quency.</p> <p>Receiver modulated audio is inhibited at spans above 158 kHz. Switch display to Mod Scope or use Demod at Marker function to hear audio at wider spans.</p>
--	---

Start Frequency (Spectrum Analyzer submenu)

Displays the Start Frequency dialog where you can input the lowest frequency currently measured and shown on the receiver display.

Range	250 kHz to 1.5 GHz
Default	495 MHz
Saved State	Saved with instrument state
Notes	<p>When adjusting the start frequency the stop frequency is held constant, meaning that both the center frequency and span will change.</p> <p>The analyzer automatically centers the frequency display midway between Start and Stop frequencies.</p>

Stop Frequency (Spectrum Analyzer submenu)

Displays the Stop Frequency dialog where you can input the highest frequency currently measured and shown on the receiver display.

Range	260 kHz to 3 GHz
Default	1 MHz

Saved State	Saved with instrument state
Notes	When adjusting the stop frequency the start frequency is held constant, meaning that both the center frequency and span will change. The analyzer automatically centers the frequency display midway between Start and Stop frequencies.

Reference Level (Spectrum Analyzer submenu)

Displays the Reference Level dialog where you can input the value of the top graticule line.

Range	0 to 90 dBm
Default	0 dBm
Saved State	Saved with instrument state

Vertical Scale (Spectrum Analyzer submenu)

Activates a horizontal soft key menu where you can select the Y-axis scale.

Discrete Values	10 dB/div, 5 dB/div, 2 dB/div, 1 dB/div
Default	10 dB/div
Saved State	Saved with instrument state

Display Mode (Spectrum Analyzer submenu)

Activates a horizontal soft key menu where you can select the trace graphing mode.

Discrete Values	Normal, Freeze, Max Hold, Average
Default	Normal
Saved State	Saved with instrument state
Notes	<p>Normal – The display updates continuously.</p> <p>Freeze – The display provides a snapshot of the current display indication and stops additional updates. In Freeze Mode, the R8200 reacquires data and updates the display whenever Center Marker or Center Peak is pressed.</p> <p>Max Hold – The display retains the highest peak signal amplitudes measured during successive sweeps.</p> <p>Average – The displayed signal amplitudes are a rolling average of the peak amplitudes measured on each successive sweep. The average consists of one to five sweeps, shown beside the mode indication.</p>

Trace Math (Spectrum Analyzer submenu)

Activates a horizontal soft key menu where you can select the trace math to be applied.

Discrete Values	None, Spec-Ref (log), ISpec-Ref (lin), Spec+Ref (lin)
Default	None
Saved State	Saved with instrument state
Notes	Setting Display Mode to Average minimizes effects of a low level / high variance signal such as the noise floor.

	<p>The underlying units of the result are no longer dBm but dB for the displayed spectrum and thus marker power.</p> <p>The following are horizontal menu choices.</p> <p>None – This selection hides the reference trace and displays the spectrum resulting from the Display Mode unmodified.</p> <p>Spec-Ref (log) – This selection displays the difference of the Display Mode spectrum in dBm minus the reference trace in dBm, which normalizes the spectrum to 0 on the Y-axis. Subsequently, spectrum power interpreted as dBm above the reference.</p> <p>ISpec-Refl (lin) – This choice displays the logarithm of the absolute value of the difference of the Display Mode spectrum in volts² minus the reference trace in volts².</p> <p>Although the absolute value of the difference avoids logarithm of negatives, it has the side effect of increasing the apparent noise power.</p> <p>Spec+Ref (lin) – This choice displays the logarithm of the sum of the Display Mode spectrum in volts² plus the reference trace in volts².</p>
--	--

Set Reference Trace (Spectrum Analyzer submenu)

Saves the current trace as a separate blue reference trace.

Notes	<p>The trace is copied from what is currently shown, which is after any Display Mode processing as well as Trace Math computations. Therefore, ensure that both of those settings are appropriately set (i.e., Trace Math is None); setting the reference when Trace Math is active may yield incoherent results. Setting Display Mode to Average minimizes effects of a low level / high variance signal such as the noise floor. This static trace is used for computations when a Trace Math equation is specified and may simply be viewed even when one is not. It can be hidden by selecting Trace Math None.</p> <p>System changes that may invalidate the reference trace include port, amplification, attenuation, frequency, span, temperature, and calibration.</p>
-------	--

Detector (Spectrum Analyzer submenu)

Activates a horizontal soft key menu where you can select the Detector mode.

Discrete Values	Power, Peak, Sample, Mean, Valley
Default	Peak
Saved State	Saved with instrument state

3 dB Marker (Spectrum Analyzer submenu)

Activates a horizontal soft key menu where you can select the 3 dB Marker mode.

Discrete Values	Off, Frequency, Delta
Default	Off
Saved State	Saved with instrument state
Notes	<p>Off – Deactivates markers.</p> <p>Frequency – This selection places a marker above and below center frequency where the signal is -3 dB below the peak amplitude measured at center frequency. The upper and lower frequencies are shown on the display.</p> <p>Delta – This selection places a marker above and below center frequency where the signal is -3 dB below the peak amplitude measured at center frequency. The difference between these two frequencies is shown on the display.</p>

Marker Mode (Spectrum Analyzer submenu)

Activates a horizontal soft key menu where you can select the Marker type and operating state.

Discrete Values	Off, Absolute, Delta
Default	Off
Saved State	Saved with instrument state
Notes	Markers can be turned off or on with a choice of numeric readout for the signal measurements. Absolute provides actual peak readings while Delta measures the relative difference of both power and frequency between the markers. Depending on the installed options, up to four markers can be enabled and selected for positioning while in Instrument Mode.

Select Marker (Spectrum Analyzer submenu)

Activates a horizontal soft key menu where you can select the marker to activate.

Discrete Values	1, 2, 3, 4
Default	1
Saved State	Saved with instrument state

Center Marker (Spectrum Analyzer submenu)

Moves the active marker to the middle of the spectrum.

Find Peak (Spectrum Analyzer submenu)

Moves the marker to the highest signal peak and displays the amplitude and frequency.

Center Peak (Spectrum Analyzer submenu)

Centers the operating frequency and display around the highest peak signal within the display range.

Demod At Marker (Spectrum Analyzer submenu)

When the Marker Mode is Absolute, this function demodulates the carrier and provides audio for the signal at the marker location.

Discrete Values	Off, Single, Continuous
Default	Off
Saved State	Saved with instrument state
Notes	<p>Off – Function is off.</p> <p>Single – Provides a one-time demodulation of the carrier signal located at the marker position for a quick listen at the marker frequency. Moving the marker or changing the monitor frequency, mode, or DISPLAY Zone selection switches the Demod At Marker function Off.</p> <p>Continuous – Enables moving the selected marker to demodulate carriers across the entire displayed spectrum. On full-screen instruments, the user can setup several markers on various peaks and use the marker selection to quickly demodulate and listen to those peaks. Additionally, on the Dual Display, the user can simultaneously view the Modulation Scope while tuning the marker positions.</p> <p>To ensure audio is demodulated, the marker must be close enough to overlap the R8200 Monitor Bandwidth around the carrier frequency. Large Span settings increase marker frequency step size, limiting how close the marker can get to the actual frequency. To minimize step size, use the narrowest span practical when displaying multiple carriers.</p>

OBW (Spectrum Analyzer submenu)

Activates the OBW (occupied bandwidth) dialog where you can set the operating state of the occupied bandwidth parameter.

Discrete Values	Off, On
Default	Off
Saved State	Saved with instrument state

OBW % (Spectrum Analyzer submenu)

Activates the OBW % dialog where you can input ratio of power contained in a bandwidth.

Range	70 % to 99 %
Default	99 %
Saved State	Saved with instrument state
Notes	The Spectrum Analyzer provides a numerical readout of the bandwidth and contained power.

CW Harmonics (Spectrum Analyzer submenu)

Activates four upper harmonics of the current Generator center frequency in Duplex mode.

Discrete Values	Off, On
Default	Off
Saved State	Saved with instrument state
Notes	Only available in full-screen display mode.

Measure Harmonics (Spectrum Analyzer submenu)

Measures and displays the frequency and relative power of the fundamental and four upper harmonics enabled by the CW Harmonics soft key.

Modulation Scope Soft Keys

In the Modulation Scope Instrument Mode, the R8200 emulates a stand-alone instrument that displays the internally-processed RF modulation waveforms. It automatically switches between Generator and Monitor modulation depending on which mode is selected. In Duplex Mode an additional soft key allows manual selection of the Monitor or Generator modulation waveform.

Vertical Scale (Modulation Scope submenu)

Activates a horizontal soft key menu where you can select the vertical scale-per-division.

Discrete Values	FM – 100, 200, 500 Hz and 1, 2, 5, 10, 20, 50 kHz AM – 1% to 50%
Default	1 kHz
Saved State	Saved with instrument state
Dependencies	The display units presented are dependent on the modulation setting in the RF Zone. For FM the units are in Hz and kHz deviation, ranging from 100 Hz/Div to 50 kHz/Div. For AM the units are in % modulation depth and range from 1%/Div to 50%/Div

Horizontal Scale (Modulation Scope submenu)

Displays the Horizontal Scale dialog where you can select the horizontal time scale resolution for the display's major grid lines.

Discrete Values	20, 50, 100, 200, 500 μ s and 1, 2, 5, 10, 20, 50, 100, 200, 500 ms and 1 s
Default	20 ms
Saved State	Saved with instrument state

Marker Mode (Modulation Scope submenu)

Activates a horizontal soft key menu where you can select the Marker type and operating state.

Discrete Values	Off, Delta V, Delta T, 1/Delta T
Default	Off
Saved State	Saved with instrument state
Notes	Depending on the installed options, up to four markers can be enabled and selected for positioning while in Instrument Mode. Off – Deactivates markers. Delta V – The numeric reading shows the difference in amplitude between marker positions. Delta T – The numeric reading shows the difference in time between marker positions. 1/DeltaT – The numeric reading shows the inverse of the time difference between markers, which can be used to determine the frequency of a repetitive waveform.

Toggle Marker (Modulation Scope submenu)

Cycles through the available markers to select a marker for repositioning along the trace.

Trigger Mode (Modulation Scope submenu)

Activates a horizontal soft key menu where you can select the Modulation Scope Trigger Mode.

Discrete Values	Auto, Normal, Single
-----------------	----------------------

Default	Auto
Saved State	Saved with instrument state
Notes	<p>Auto – If a signal satisfying the Trigger Edge and Trigger Level settings is present, the display will sweep as in Normal Mode. If no signal satisfying the Trigger Edge and Trigger Level settings is present, then the display sweeps continuously until a signal satisfying the settings is acquired.</p> <p>Normal – The display sweeps only when the input signal satisfies the Trigger Edge and Trigger Level settings.</p> <p>Single – The display sweeps once after a key press is performed on the Single soft key if the signal satisfies the Trigger Edge and Trigger level settings.</p>

Trigger Level (Modulation Scope submenu)

Activates a Trigger Level dialog where you can adjust the signal threshold at which a horizontal sweep is initiated.

Range	FM – 0 to 200 kHz AM – 0 to 99 %
Default	0
Saved State	Saved with instrument state

Trigger Edge (Modulation Scope submenu)

Activates a horizontal soft key menu where you can select the mod scope trigger type.

Discrete Values	Rising, Falling, Either
-----------------	-------------------------

Default	Rising
Saved State	Saved with instrument state

Vertical Position (Modulation Scope submenu)

Activates a horizontal soft key menu where you can adjust the waveform position up or down in fixed increments.

Discrete Values	Move Down, Move Up
Default	Move Down
Saved State	Saved with instrument state

Scope Mode (Modulation Scope submenu)

When operating in Duplex Mode, pressing this soft key activates a Scope Mode dialog where you can select the modulation waveform from the Monitor or the Generator.

Discrete Values	Monitor, Generate
Default	Monitor
Saved State	Saved with instrument state

Oscilloscope Soft Keys

In the Oscilloscope Instrument Mode the R8200 emulates a stand-alone general-purpose Oscilloscope with calibrated vertical input sensitivities and automatic or triggered horizontal sweep rates. Use the scope to analyze waveforms, detect asymmetric modulation or audio distortion, trace signals, and troubleshoot subsystems or circuits. The Meter In port serves as the vertical input for the Oscilloscope.

Coupling (Oscilloscope submenu)

Displays the Coupling dialog where you can select the input coupling for the external signal applied to the Meter In port.

Discrete Values	DC, AC
Default	DC
Saved State	Saved with instrument state

Horizontal Scale (Oscilloscope submenu)

Displays the Horizontal Scale input dialog where you can select the horizontal scale.

Discrete Values	20, 50, 100, 200, 500 μ s and 1, 2, 5, 10, 20, 50, 100, 200, 500 ms and 1 s
Default	1 ms
Saved State	Saved with instrument state
Notes	Digital Oscilloscopes are susceptible to aliasing, which can cause inaccurate signal reconstruction. The Maximum recommended input frequency for each horizontal scale setting is shown in the display area. For best results, follow the guidelines shown in the table below.

	Horizontal Scale	Max Signal Frequency	Max Recommended Signal Frequency
	20 μ s	50000 Hz	50000 Hz
	50 μ s	50000 Hz	20000 Hz
	100 μ s	50000 Hz	10000 Hz
	200 μ s	25000 Hz	5000 Hz
	500 μ s	10000 Hz	2000 Hz
	1 ms	5000 Hz	1000 Hz
	2 ms	2500 Hz	500 Hz
	5 ms	1000 Hz	200 Hz
	10 ms	500 Hz	100 Hz
	20 ms	250 Hz	50 Hz
	50 ms	100 Hz	20 Hz
	100 ms	50 Hz	10 Hz
	200 ms	25 Hz	5 Hz
	500 ms	10 Hz	2 Hz
	1 s	5 Hz	1 Hz

Vertical Scale (Oscilloscope submenu)

Displays the Vertical Scale dialog where you can select the vertical scale resolution for the display's major grid lines.

Discrete Values	50, 100, 200, 500 mV and 1, 2, 5, 10, 15, 20, 25 V
Default	1 V
Saved State	Saved with instrument state

Marker Mode (Oscilloscope submenu)

Activates a horizontal soft key menu where you can select the select the Marker type and operating state.

Discrete Values	Off, Delta V, Delta T, 1/Delta T
Default	Off
Saved State	Saved with instrument state
Notes	<p>Off – Deactivates markers.</p> <p>Depending on the installed options, up to four markers can be enabled and positioned. Markers can provide several different numerical displays:</p> <p>Delta V – shows the difference in amplitude between marker positions.</p> <p>Delta T – shows the difference in time between marker positions.</p> <p>1/Delta T – shows the inverse of the time difference between markers, which can be used to determine the frequency of a repetitive waveform.</p>

Toggle Marker (Oscilloscope submenu)

Cycles through the available markers to select a marker for repositioning along the trace.

Notes	The highlighted marker is yellow.
-------	-----------------------------------

Trigger Mode (Oscilloscope submenu)

Activates a horizontal soft key menu where you can select the horizontal sweep trigger mode.

Discrete Values	Auto, Normal, Single
-----------------	----------------------

Default	Auto
Saved State	Saved with instrument state
Notes	<p>Auto – If a signal satisfying the Trigger Edge and Trigger Level settings is present, the display will sweep as in Normal Mode. If no signal satisfying the Trigger Edge and Trigger Level settings is present, then the display sweeps continuously until a signal satisfying the settings is acquired.</p> <p>Normal – The display sweeps only when the input signal satisfies the Trigger Edge and Trigger Level settings.</p> <p>Single – The display sweeps once after a key press is performed on the Single soft key.</p>

Trigger Level (Oscilloscope submenu)

Adjusts the signal threshold at which a horizontal sweep is initiated.

Range	–100 to 100 V
Default	0 V
Saved State	Saved with instrument state

Trigger Position (Oscilloscope submenu)

Activates a horizontal soft key menu where you can select the amount of pre-trigger waveform preceding the trigger threshold.

Discrete Values	10%, 50%, 90%
Default	50%
Saved State	Saved with instrument state

Trigger Edge (Oscilloscope submenu)

Activates a horizontal soft key menu where you can select which waveform edge triggers the Modulation Scope sweep.

Discrete Values	Rising, Falling, Either
Default	Rising
Saved State	Saved with instrument state

Vertical Position (Oscilloscope submenu)

Activates a horizontal soft key menu where you can adjust the waveform up or down on the display.

Discrete Values	Move Down, Move Up
Default	Move Down
Saved State	Saved with instrument state

Set DC Offset (Oscilloscope submenu)

Zeros or compensates for any accumulated DC offset caused by drift in the input amplifier of the R8200 over long periods of time.

Notes	This may show up as a DC level indicated on the Oscilloscope and DC Voltmeter when no input is connected to the Meter In port. With the Meter In port disconnected, press the soft key to eliminate the offset. The compensation is stored permanently in the R8200 until the next time this soft key is pressed.
-------	---

Dual Display Soft Keys

In the Dual Display Instrument Mode, the R8200 provides a convenient single-screen presentation of two instruments often used together, the Spectrum Analyzer and Modulation Scope, enabling the independent configuration and display of both measurements. The submenus, control, and parameter entry are unchanged from the full screen versions of the Spectrum Analyzer and Modulation Scope.

Select Instrument (Dual Display submenu)

Activates a horizontal soft key menu where you can select the active Dual Display instrument.

Discrete Values	Spectrum Analyzer, Modulation Scope
Default	Spectrum Analyzer
Saved State	Saved with instrument state

Center Frequency (Spectrum Analyzer submenu)

When Select Instrument is set to Spectrum Analyzer, pressing this soft key displays the Center Frequency dialog where you can enter the center frequency for the receiver display.

Range	250 kHz to 3.0 GHz
Default	500 MHz
Saved State	Saved with instrument state

Span (Spectrum Analyzer submenu)

When Select Instrument is set to Spectrum Analyzer, pressing this soft key displays the Span dialog where you can input the desired frequency span for the receiver.

Range	10 kHz to 20 MHz
Default	10 MHz
Saved State	Saved with instrument state
Notes	<p>Receiver modulated audio is inhibited at spans above 158 kHz. Switch display to Mod Scope or use Demod at Marker function to hear audio at wider spans.</p> <p>Frequency span allows you to zoom in or out (change the span of the X-axis) on a signal of interest, while maintaining the relative power (Y-axis). To zoom in on a signal, decrease the frequency span while maintaining the signal at center frequency. To zoom out, increase the frequency span. The value entered for Span is automatically split between each side of the current center frequency.</p>

Start Frequency (Spectrum Analyzer submenu)

When Select Instrument is set to Spectrum Analyzer, pressing this soft key displays the Start Frequency dialog where you can input the lowest frequency currently measured and shown on the receiver display.

Range	250 kHz to 1.5 GHz
Default	495 MHz
Saved State	Saved with instrument state
Notes	<p>When adjusting the start frequency the stop frequency is held constant, meaning that both the center frequency and span will change.</p> <p>The analyzer automatically centers the frequency display midway between Start and Stop frequencies.</p>

Stop Frequency (Spectrum Analyzer submenu)

When Select Instrument is set to Spectrum Analyzer, pressing this soft key displays the Stop Frequency dialog where you can input the highest frequency currently measured and shown on the receiver display.

Range	260 kHz to 3 GHz
Default	1 MHz
Saved State	Saved with instrument state
Notes	When adjusting the stop frequency the start frequency is held constant, meaning that both the center frequency and span will change. The analyzer automatically centers the frequency display midway between Start and Stop frequencies.

Reference Level (Spectrum Analyzer submenu)

When Select Instrument is set to Spectrum Analyzer, pressing this soft key displays the Reference Level dialog where you can input the value of the top graticule line.

Range	0 to 90 dBm
Default	0 dBm
Saved State	Saved with instrument state

Vertical Scale (Spectrum Analyzer submenu)

When Select Instrument is set to Spectrum Analyzer, pressing this soft key activates a horizontal soft key menu where you can select the Y-axis scale.

Discrete Values	10 dB/div, 5 dB/div, 2 dB/div, 1 dB/div
Default	10 dB/div
Saved State	Saved with instrument state

Display Mode (Spectrum Analyzer submenu)

When Select Instrument is set to Spectrum Analyzer, pressing this soft key activates a horizontal soft key menu where you can select the trace graphing mode.

Discrete Values	Normal, Freeze, Max Hold, Average
Default	Normal
Saved State	Saved with instrument state
Notes	<p>Normal – The display updates continuously.</p> <p>Freeze – The display provides a snapshot of the current display indication and stops additional updates. In Freeze Mode, the R8200 reacquires data and updates the display whenever Center Marker or Center Peak is pressed.</p> <p>Max Hold – The display retains the highest peak signal amplitudes measured during successive sweeps.</p> <p>Average – The displayed signal amplitudes are a rolling average of the peak amplitudes measured on each successive sweep. The average consists of one to five sweeps, shown beside the mode indication.</p>

Trace Math (Spectrum Analyzer submenu)

When Select Instrument is set to Spectrum Analyzer, pressing this soft key activates a horizontal soft key menu where you can select the trace math to be applied.

Discrete Values	None, Spec-Ref (log), ISpec-Refl (lin), Spec+Ref (lin)
Default	None
Saved State	Saved with instrument state
Notes	<p>The underlying units of the result are no longer dBm but dB for the displayed spectrum and thus marker power.</p> <p>None – This selection hides the reference trace and displays the spectrum resulting from the Display Mode unmodified.</p> <p>Spec-Ref (log) – This selection displays the difference of the Display Mode spectrum in dBm minus the reference trace in dBm, which normalizes the spectrum to 0 on the Y-axis. Subsequently, spectrum power is shown on the display and measured by absolute markers relative to the reference trace, i.e., correctly interpreted as dBm above the reference.</p> <p>ISpec-Refl (lin) – This choice displays the logarithm of the absolute value of the difference of the Display Mode spectrum in volts² minus the reference trace in volts².</p> <p>Although the absolute value of the difference avoids logarithm of negatives, it has the side effect of increasing the apparent noise power.</p> <p>Spec+Ref (lin) – This choice displays the logarithm of the sum of the Display Mode spectrum in volts² plus the reference trace in volts².</p>

Set Reference Trace (Spectrum Analyzer submenu)

When Select Instrument is set to Spectrum Analyzer, pressing this soft key saves the current trace as a separate blue reference trace.

Notes	<p>The trace is copied from what is currently shown, which is after any Display Mode processing as well as Trace Math computations. Therefore, ensure that both of those settings are appropriately set (i.e., Trace Math is None); setting the reference when Trace Math is active may yield incoherent results. Setting Display Mode to Average minimizes effects of a low level / high variance signal such as the noise floor. This static trace is used for computations when a Trace Math equation is specified and may simply be viewed even when one is not. It can be hidden by selecting Trace Math None.</p> <p>System changes that may invalidate the reference trace include port, amplification, attenuation, frequency, span, temperature, and calibration.</p>
-------	--

Detector (Spectrum Analyzer submenu)

When Select Instrument is set to Spectrum Analyzer, pressing this soft key activates a horizontal soft key menu where you can select the Detector mode.

Discrete Values	Power, Peak, Sample, Mean, Valley
Default	Peak
Saved State	Saved with instrument state

3 dB Marker (Spectrum Analyzer submenu)

When Select Instrument is set to Spectrum Analyzer, pressing this soft key activates a horizontal soft key menu where you can select the 3 dB Marker mode.

Discrete Values	Off, Frequency, Delta
-----------------	-----------------------

Default	Off
Saved State	Saved with instrument state
Notes	<p>Off – Deactivates markers.</p> <p>Frequency – This selection places a marker above and below center frequency where the signal is -3 dB below the peak amplitude measured at center frequency. The upper and lower frequencies are shown on the display.</p> <p>Delta – This selection places a marker above and below center frequency where the signal is -3 dB below the peak amplitude measured at center frequency. The difference between these two frequencies is shown on the display.</p>

Marker Mode (Spectrum Analyzer submenu)

When Select Instrument is set to Spectrum Analyzer, pressing this soft key activates a horizontal soft key menu where you can select the Marker type and operating state.

Discrete Values	Off, Absolute, Delta
Default	Off
Saved State	Saved with instrument state
Notes	<p>Off – Deactivates markers.</p> <p>Absolute – This selection displays the frequency and absolute signal amplitude for each marker selected.</p> <p>Delta – This selection displays the frequency and amplitude difference between each pair of markers selected.</p> <p>Depending on the installed options, up to four markers can be enabled and selected for positioning while in Instrument Mode.</p>

Toggle Marker (Spectrum Analyzer submenu)

When Select Instrument is set to Spectrum Analyzer, pressing this soft key activates a horizontal soft key menu where you can select the Marker type and operating state.

Discrete Values	Off, Absolute, Delta
Default	Off
Saved State	Saved with instrument state
Notes	Off – Deactivates markers. Absolute – This selection displays the frequency and absolute signal amplitude for each marker selected. Delta – This selection displays the frequency and amplitude difference between each pair of markers selected. Depending on the installed options, up to four markers can be enabled and selected for positioning while in Instrument Mode.

Center Marker (Spectrum Analyzer submenu)

When Select Instrument is set to Spectrum Analyzer, pressing this soft key moves the active marker to the middle of the spectrum.

Find Peak (Spectrum Analyzer submenu)

When Select Instrument is set to Spectrum Analyzer, pressing this soft key moves the active marker to highest trace peak.

Center Peak (Spectrum Analyzer submenu)

When Select Instrument is set to Spectrum Analyzer, pressing this soft key centers the display around the highest trace peak.

Demod at Marker (Spectrum Analyzer submenu)

When Select Instrument is set to Spectrum Analyzer and Marker Mode is set to absolute, pressing this soft key activates a horizontal soft key menu where you can select the demodulation mode at the active marker.

Discrete Values	Off, Single, Continuous
Default	Off
Saved State	Saved with instrument state
Notes	<p>Off – Function is off.</p> <p>Single – This selection provides a one-time demodulation of the carrier signal located at the marker position for a quick listen at the marker frequency. Moving the marker or changing the monitor frequency, mode, or DISPLAY Zone selection switches the Demod At Marker function Off.</p> <p>Continuous – Continuous Mode allows users to move the selected marker to demodulate carriers across the entire displayed spectrum. On full-screen instruments, the user can setup several markers on various peaks and use the marker selection to quickly demodulate and listen to those peaks. Additionally, on the Dual Display, the user can simultaneously view the deModulation Scope while tuning the marker positions.</p> <p>To ensure audio is demodulated, the marker must be close enough to overlap the analyzer Monitor Bandwidth around the carrier frequency. Large Span settings increase marker frequency step size, limiting how close the marker can get to the actual frequency. To minimize step size, use the narrowest span practical when displaying multiple carriers.</p>

Vertical Scale (Modulation Scope submenu)

When Select Instrument is set to Mod Scope, pressing this soft key activates a horizontal soft key menu where you can select the vertical scale-per-division.

Discrete Values	FM – 100, 200, 500 Hz and 1, 2, 5, 10, 20, 50 kHz AM – 1%/ to 50%
Default	1 kHz
Saved State	Saved with instrument state
Dependencies	The display units presented are dependent on the modulation setting in the RF Zone. For FM the units are in Hz and kHz deviation, ranging from 100 Hz/Div to 50 kHz/Div. For AM the units are in % modulation depth and range from 1%/Div to 50%/Div

Horizontal Scale (Modulation Scope submenu)

When Select Instrument is set to Mod Scope, pressing this softkey displays the Horizontal Scale dialog where you can select the horizontal scale.

Discrete Values	20, 50, 100, 200, 500 μ s and 1, 2, 5, 10, 20, 50, 100, 200, 500 ms and 1 s
Default	20 ms
Saved State	Saved with instrument state

Marker Mode (Modulation Scope submenu)

When Select Instrument is set to Mod Scope, pressing this soft key activates a horizontal soft key menu where you can select the Marker type and operating state.

Discrete Values	Off, Delta V, Delta T, 1/Delta T
Default	Off
Saved State	Saved with instrument state
Notes	<p>Off – Deactivates markers.</p> <p>Delta V – The numeric reading shows the difference in amplitude between marker positions.</p> <p>Delta T – The numeric reading shows the difference in time between marker positions.</p> <p>1/DeltaT – The numeric reading shows the inverse of the time difference between markers, which can be used to determine the frequency of a repetitive waveform.</p> <p>Depending on the installed options, up to four markers can be enabled and selected for positioning while in Instrument Mode.</p>

Toggle Marker (Modulation Scope submenu)

When Select Instrument is set to Mod Scope pressing this soft key switches between Marker 1 and 2.

Trigger Mode (Modulation Scope submenu)

When Select Instrument is set to Mod Scope, pressing this soft key activates a horizontal soft key menu where you can select the Modulation Scope Trigger Mode.

Discrete Values	Auto, Normal, Single
Default	Auto
Saved State	Saved with instrument state

Notes	<p>Auto – If a signal satisfying the Trigger Edge and Trigger Level settings is present, the display will sweep as in Normal Mode. If no signal satisfying the Trigger Edge and Trigger Level settings is present, then the display sweeps continuously until a signal satisfying the settings is acquired.</p> <p>Normal – The display sweeps only when the input signal satisfies the Trigger Edge and Trigger Level settings.</p> <p>Single – The display sweeps once after a key press is performed on the Single soft key if the signal satisfies the Trigger Edge and Trigger level settings.</p> <p>Spec An and Bar Graphs are not available in Generate Mode.</p>
-------	---

Trigger Level (Modulation Scope submenu)

When Select Instrument is set to Mod Scope, pressing this soft key activates a Trigger Level dialog where you can enter the trigger threshold level in kHz.

Range	<p>FM – 0 to 200 kHz</p> <p>AM – 0 to 99 %</p>
Default	0
Saved State	Saved with instrument state

Trigger Edge (Modulation Scope submenu)

When Select Instrument is set to Mod Scope, pressing this soft key activates a horizontal soft key menu where you can select the mod scope trigger type.

Discrete	Rising, Falling, Either
----------	-------------------------

Values	
Default	Rising
Saved State	Saved with instrument state

Vertical Position (Modulation Scope submenu)

When Select Instrument is set to Mod Scope, pressing this soft key activates a horizontal soft key menu where you can adjust the waveform position up or down in fixed increments.

Discrete Values	Move Down, Move Up
Default	Move Down
Saved State	Saved with instrument state

Tracking Generator Soft Keys

In the optional Tracking Generator Instrument Mode, the Communications System Analyzer behaves like a stand-alone instrument, configuring the RF generator in a swept mode for simultaneous use with the Spectrum Analyzer display. This delivers a valuable capability for measuring and servicing a wide variety of RF filtering and combining networks.

Center Frequency (Tracking Generator submenu)

Displays a Center Frequency generator where you can set the Tracking Generator Center Frequency in MHz

Range	250 kHz to 3 GHz
Default	500 MHz
Saved State	Saved with instrument state

Span (Tracking Generator submenu)

Displays a Span dialog where you can set the Tracking Generator Span in MHz.

Range	0.000001 to 50 MHz
Default	50 MHz
Saved State	Saved with instrument state
Notes	The Span entry total is automatically split on each side of the current center frequency.

Start Frequency (Tracking Generator submenu)

Displays a Start Frequency dialog, where you can set the Tracking Generator start frequency in MHz.

Range	250 kHz to 3 GHz
Default	475 MHz
Saved State	Saved with instrument state
Notes	Spec An and Bar Graphs are not available in Generate Mode.
Couplings	The analyzer automatically centers the frequency display midway between Start and Stop frequencies.

Stop Frequency (Tracking Generator submenu)

Displays a Stop Frequency dialog, where you can set the Tracking Generator stop frequency in MHz.

Range	260 kHz to 3 GHz
Default	525 MHz
Saved State	Saved with instrument state
Notes	The analyzer automatically centers the frequency display midway between Start and Stop frequencies.

Reference Level (Tracking Generator submenu)

Displays a Reference Level dialog where you can set the Y offset of the display.

Range	-120 to 60 dB
Default	0 dB
Saved State	Saved with instrument state

Vertical Scale (Tracking Generator submenu)

Activates a horizontal soft key menu where you can select the vertical scale.

Discrete Values	15, 10, 5, 2, 1 dB/div
Default	10 dB/div
Saved State	Saved with instrument state

of Points (Tracking Generator submenu)

Displays a # of Points dialog where you can set the number of points per sample.

Range	100 to 600
Default	200
Saved State	Saved with instrument state
Notes	Higher settings increase the trace resolution for viewing signal detail but also slow the update rate.

RBW (Tracking Generator submenu)

Activates a horizontal menu where you can set the Tracking Generator Resolution Bandwidth.

Discrete Values	Wide, Medium, Narrow
-----------------	----------------------

Default	Medium
Saved State	Saved with instrument state
Notes	RBW controls the amount of averaging done. Wide RBW provides minimal sampling and a faster response time. Medium RBW provides a moderate amount of sampling with a reduced response time. Narrow RBW provides the most sampling with a slow response time, but a greater dynamic range.

Display Mode (Tracking Generator submenu)

Activates a horizontal soft key menu where you can select the trace graphing mode.

Discrete Values	Normal, Freeze, Max Hold, Average
Default	Normal
Saved State	Saved with instrument state
Notes	<p>Normal – The display updates continuously.</p> <p>Freeze – The display provides a snapshot of the current display indication and stops additional updates. In Freeze Mode, the R8200 reacquires data and updates the display whenever Center Marker or Center Peak is pressed.</p> <p>Max Hold – The display retains the highest peak signal amplitudes measured during successive sweeps.</p> <p>Average – The displayed signal amplitudes are a rolling average of the peak amplitudes measured on each successive sweep. The average consists of one to five sweeps, shown beside the mode indication.</p>

Marker Mode (Tracking Generator submenu)

Activates a horizontal soft key menu where you can select the Tracking Generator Marker type and operating state.

Discrete Values	Off, Absolute, Delta
Default	Off
Saved State	Saved with instrument state
Notes	Off – Deactivates markers. Absolute – Displays the frequency and absolute signal amplitude for each marker selected. Delta – Displays the frequency and amplitude difference between each pair of markers selected.

Marker Type (Tracking Generator submenu)

Activates a horizontal soft key menu where you can select the Marker Type.

Discrete Values	Point Cross, Vertical Bar, Horizontal Bar, Full Cross
Default	Point Cross
Saved State	Saved with instrument state
Notes	Point Cross – Displays a small cross with window over the marker point. Vertical Bar – Displays a vertical bar at the marker point. Horizontal Bar – Displays a horizontal bar at the marker point. Full Cross – Displays both a horizontal and vertical bar at the marker point.

Select Marker (Tracking Generator submenu)

Activates a horizontal soft key menu where you can select the active marker.

Discrete Values	1, 2, 3, 4
Default	1
Saved State	Saved with instrument state

Set Marker Frequency (Tracking Generator submenu)

Activates a horizontal soft key menu where you can select the vertical scale.

Range	Start Frequency to Stop Frequency
Default	400 MHz
Saved State	Saved with instrument state

Find Peak (Tracking Generator submenu)

Moves the active marker to the highest point on the waveform.

Find Valley (Tracking Generator submenu)

Moves the active marker to the lowest point on the waveform.

Center Marker (Tracking Generator submenu)

Centers the operating frequency and display around the active marker.

3 dB Marker (Tracking Generator submenu)

Activates a horizontal soft key menu where you can select the 3dB Marker mode.

Discrete Values	Off, Frequency, Delta
Default	Off
Saved State	Saved with instrument state
Notes	Off – Function is off. Frequency – This selection places a marker above and below center frequency where the signal is –3 dB below the peak amplitude measured at center frequency. The upper and lower frequencies are shown on the display. Delta – This selection places a marker above and below center frequency where the signal is –3 dB below the peak amplitude measured at center frequency. The difference between these two frequencies is shown on the display.

Output Level (Tracking Generator submenu)

Displays an Output Level dialog where you can set the RF Level of the Tracking Generator output at the active port.

Range	RF Gen Out port: –95 to 5 dBm RF In/Out port: –130 to –30 dBm
Default	–50 dBm
Saved State	Saved with instrument state
Notes	If the R8_Gen_Ext Option is enabled, then the RF Gen Port range is –125 dBm to +5 dBm.

Attenuation (Tracking Generator submenu)

Displays an Attenuation dialog where you can set the input attenuation in dB.

Discrete Values	0 to 62 dB in 2 dB steps
Default	0 dB
Saved State	Saved with instrument state
Notes	Spec An and Bar Graphs are not available in Generate Mode.

Pre-Amplifier (Tracking Generator submenu)

Displays a Pre-Amplifier dialog where you can select the Pre-Amplifier power state.

Discrete Values	Off, On						
Default	Off						
Saved State	Saved with instrument state						
Notes	<p>AMP appears next to the Attenuation setting in the RF Zone whenever the Pre-Amplifier is active.</p> <p>By default, the pre-amplifier Auto-Off feature disables the pre-amplifier for best accuracy during broadband power (Watt Meter) measurements. When enabled, avoid input overload and erroneous signal strength readings by using the pre-amplifier only under the following conditions:</p> <table border="1"><thead><tr><th>Monitor Port</th><th>Maximum input level for using pre-amplifier</th></tr></thead><tbody><tr><td>Antenna</td><td>(Input signal in dBm – Attenuator setting) is equal or less than –40 dBm</td></tr><tr><td>RF In/Out</td><td>(Input signal in dBm – Attenuator setting) is equal or less than –10 dBm</td></tr></tbody></table>	Monitor Port	Maximum input level for using pre-amplifier	Antenna	(Input signal in dBm – Attenuator setting) is equal or less than –40 dBm	RF In/Out	(Input signal in dBm – Attenuator setting) is equal or less than –10 dBm
Monitor Port	Maximum input level for using pre-amplifier						
Antenna	(Input signal in dBm – Attenuator setting) is equal or less than –40 dBm						
RF In/Out	(Input signal in dBm – Attenuator setting) is equal or less than –10 dBm						

Gen Port (Tracking Generator submenu)

Activates a horizontal soft key menu where you can select the vertical scale.

Discrete Values	RF In/Out, Gen Out
Default	Gen Out
Saved State	Saved with instrument state
Notes	If RF Level Offset is enabled, the Gen Port label is cyan-colored, indicating that Output Level amplitudes are adjusted by the Gen Port-specific offset.

Monitor Port (Tracking Generator submenu)

Activates a horizontal soft key menu where you can select the receiver's input.

Discrete Values	RF In/Out, Antenna
Default	Antenna
Saved State	Saved with instrument state
Notes	If RF Level Offset is enabled, the Mon Port label is cyan-colored, indicating that RX measurements are adjusted by the Mon Port-specific offset.

Normalize (Tracking Generator submenu)

Displays a Normalize dialog where you can set the operating state for normalization.

Discrete Values	Off, On
Default	Off
Saved State	Saved with instrument state
Notes	Normalization creates a baseline for measuring system under test response by zeroing out the Spectrum Analyzer trace. When enabled, a visual indicator appears, and the trace color changes. To reset the baseline after changing any Tracking Generator parameters, select Off and then On again.

Cable Fault Locator Soft Keys

In the Cable Fault Locator Instrument Mode, the R8200 emulates a stand-alone instrument.

Cable Type (Cable Fault Locator submenu)

Displays a Cable Type dialog, where you can select the Cable Fault Locator cable type.

Discrete Values	No Selection, LADDER LINE, TWIN-LEAD, COAXIAL-FPD, COAXIAL-SPD
Default	No Selection
Saved State	Saved with instrument state
Notes	Automatically populates the Cable Loss and Velocity Factor. If No Selection is chosen, the user should enter the specific data for the cable under test.

Center Frequency (Cable Fault Locator submenu)

Displays a Center Frequency dialog, where you can enter the Cable Fault Locator Center Frequency in MHz.

Range	250 kHz to 1 GHz
Default	500 MHz
Saved State	Saved with instrument state

Maximum Length (Cable Fault Locator submenu)

Displays a Maximum Length dialog where you can input the Maximum Length to optimize the RF parameters and FFT calculations.

Range	36.4 to 3047 m
Default	500 m
Saved State	Saved with instrument state
Notes	The entry units are determined by the Distance Units soft key.

Analyze (Cable Fault Locator submenu)

Activates a horizontal soft key menu where you can select the Cable Fault Locator operating mode.

Discrete Values	Off, Continuous, Single Sweep, Calibrate
Default	Off
Saved State	Saved with instrument state
Notes	<p>Off – This selection disables the Cable Fault Locator to allow parameter entry.</p> <p>Continuous – The display provides continuous measurement updates.</p> <p>Single Sweep – The display provides one measurement update after a key press is performed on the Single Sweep soft key.</p> <p>Calibrate – The Cable Fault Locator performs a calibration to nullify effects from the RF directional coupler/splitter.</p>

Cable Loss (Cable Fault Locator submenu)

When display is set to Mod Scope, pressing this soft key activates a horizontal soft key menu where you can select the vertical scale.

Range	0 to 2 dB/m
Default	0 dB/m
Saved State	Saved with instrument state
Notes	The entry units are determined by the Distance Units soft key.

Velocity Factor (Cable Fault Locator submenu)

Displays a Velocity Factor dialog where you can input the Cable Fault Locator Velocity Factor.

Range	0.001 to 1
Default	1
Saved State	Saved with instrument state
Notes	Changing this value will override cable under test's velocity factor if one has been loaded.

Display Mode (Cable Fault Locator submenu)

Activates a horizontal soft key menu where you can select the trace graphing mode.

Discrete Values	Normal, Freeze, Max Hold, Average
Default	Normal
Saved State	Saved with instrument state
Notes	Normal – The display updates continuously.

	<p>Freeze – This selection provides a display snapshot of the first measurement sweep started by a Continuous or Single Sweep key press in the Analyze submenu, then stops additional display updates. If a measurement sweep is already in process during the key press, the display updates when complete and then freezes. Measurement sweeps completed and displayed before the Freeze key press are not frozen and will be overwritten by the first subsequent sweep.</p> <p>Max Hold – The display retains the highest peak signal amplitudes measured during successive sweeps.</p> <p>Average – The display shows a rolling average of the peak return loss amplitude measured on each successive sweep. The average consists of one to five sweeps, shown beside the mode indication.</p>
--	--

Marker Mode (Cable Fault Locator submenu)

Activates a horizontal soft key menu where you can toggle Marker type and operating state.

Discrete Values	Off, Absolute, Delta
Default	Off
Saved State	Saved with instrument state
Notes	<p>Off – Deactivates markers.</p> <p>Absolute – This selection displays the frequency and absolute signal amplitude for each marker selected.</p> <p>Delta – This selection displays the frequency and amplitude difference between each pair of markers selected.</p> <p>Depending on the installed options, up to four markers can be enabled and selected for positioning while in Instrument Mode.</p>

Toggle Marker (Cable Fault Locator submenu)

Toggles between Marker 1 and 2.

Notes	The active marker is moved using the arrow keys.
-------	--

Find Peak (Cable Fault Locator submenu)

Moves the marker to the highest peak in the display window and provides a numeric readout of the distance and return loss.

Distance Units (Cable Fault Locator submenu)

Displays a Distance Units dialog where you can toggle between meters and feet.

Discrete Values	m, ft
Default	m
Saved State	Saved with instrument state

Add Cable Type (Cable Fault Locator submenu)

Opens a menu where you can define a new cable for use with the Cable Fault Locator.

Notes	The soft key activates a new submenu for entering a Cable Description and the associated cable specifications. These include the cable Velocity Factor along with the Nominal Attenuation Units for three frequency points. Pressing the Next soft key advances the menu to each successive Frequency/Nominal Attenuation entry. The Back soft key returns to the previous entry menu.
-------	--

Cable Description (Cable Fault Locator submenu)

Displays a Cable Description dialog where you can enter a name for your custom cable.

Velocity Factor (Cable Fault Locator submenu)

Displays a Velocity Factor dialog where you can enter

Range	0.001 to 1.000
Default	0.000
Saved State	Saved with instrument state

Nominal Attenuation Units (Cable Fault Locator submenu)

Displays a Nominal Attenuation Units dialog where you can select cable loss units.

Discrete Values	dB/m, dB/ft
Default	dB/m
Saved State	Saved with instrument state

Frequency 1 (Cable Fault Locator submenu)

Displays a Frequency dialog where you can set a cable loss frequency.

Range	0 to 3000 MHz
Default	0
Saved State	Saved with instrument state

Nominal Attenuation 1 (Cable Fault Locator submenu)

Displays a Nominal Attenuation dialog where you set a cable loss value.

Range	0.0000 to 1.0000 dB/m
Default	0
Saved State	Saved with instrument state
Notes	The entry units are determined by the Distance Units soft key.

Frequency 2 (Cable Fault Locator submenu)

Displays a Frequency dialog where you can set a cable loss frequency.

Range	0 to 3000 MHz
Default	0
Saved State	Saved with instrument state

Nominal Attenuation 2 (Cable Fault Locator submenu)

Displays a Nominal Attenuation dialog where you set a cable loss value.

Range	0.0000 to 1.0000 dB/m
Default	0
Saved State	Saved with instrument state
Notes	The entry units are determined by the Distance Units soft key.

Frequency 3 (Cable Fault Locator submenu)

Displays a Frequency dialog where you can set a cable loss frequency.

Range	0 to 3000 MHz
Default	0
Saved State	Saved with instrument state

Nominal Attenuation 3 (Cable Fault Locator submenu)

Displays a Nominal Attenuation dialog where you set a cable loss value.

Range	0.0000 to 1.0000 dB/m
Default	0
Saved State	Saved with instrument state
Notes	The entry units are determined by the Distance Units soft key.

Save New Cable (Cable Fault Locator submenu)

Saves the current new or edited cable to the analyzer.

Edit Cable (Cable Fault Locator submenu)

Opens a menu where you can edit the active Cable Type.

Notes	Factory cables cannot be edited.
-------	----------------------------------

Delete Cable (Cable Fault Locator submenu)

Opens a menu where you can delete the active Cable Type.

Discrete Values	Continue, Cancel
Notes	Factory cables cannot be deleted.

Single-Port VNA Soft Keys

In Single-Port VNA mode, the R8200 behaves like a stand-alone instrument with a full screen display. The following sections are organized by measurement parameter: Calibration, Frequency, Measure, Scale, Trace, Marker, and Files soft keys.

- For Calibration soft keys, see **"Calibration Soft Keys" on the next page.**
- For Frequency soft keys, see **"Frequency Soft Keys" on page 579.**
- For Measure soft keys, see **"Measure Soft Keys" on page 580.**
- For Scale soft keys, see **"Scale Soft Keys" on page 584.**
- For Trace soft keys, see **"Trace Soft Keys" on page 585.**
- For Marker soft keys, see **"Marker Soft Keys" on page 587.**
- For Files soft keys, see **"Files Soft Keys" on page 590.**

This section lists VNA soft keys.

Select Display (Single-Port VNA submenu)

Activates a horizontal soft key menu where you can select the Single-Port VNA display mode.

Discrete Values	Return Loss/VSWR, Distance to Fault, Smith Chart
Default	Return Loss/VSWR
Saved State	Saved with instrument state
Notes	Return Loss/VSWR – Opens the Return Loss/VSWR measurement display. Distance to Fault – Opens the Distance to Fault measurement display. Smith Chart – Opens the Smith Chart display.

Calibration... (Single-Port VNA submenu)

Opens the Calibration submenu.

Frequency... (Single-Port VNA submenu)

Opens a submenu where you can configure frequency parameters for the measurement.

Measure... (Single-Port VNA submenu)

Opens a submenu where you can configure measurement parameters like number of points, IFBW, trigger mode, etc..

Scale... (Single-Port VNA submenu)

Opens a submenu where you can configure scalar parameters.

Trace... (Single-Port VNA submenu)

Opens a submenu where you can configure trace parameters like active trace, trace memory, and trace math.

Marker... (Single-Port VNA submenu)

Opens a submenu where you can configure marker parameters.

Files... (Single-Port VNA submenu)

Opens a submenu where you can configure parameters for identifying and saving measurements.

Calibration Soft Keys

The following soft keys are unique to the Single-Port VNA Calibration display.

Calibration Kit (Calibration submenu)

Activates the Calibration Kit Library. To select a calibration kit, highlight it using the arrow keys or the tuning knob.

Select (Calibration Kit submenu)

Selects the highlighted calibration kit and loads the characteristics unique to the standards contained in the kit.

New (Calibration Kit submenu)

Activates the Calibration Kit Library Editor where you can define a custom calibration kit for use with the R8200. Use the arrow keys and the tuning knob to move the cursor through the editor.

Name (New Calibration Kit submenu)

Displays a dialog where you can enter a name for the calibration kit.

Description (New Calibration Kit submenu)

Displays a dialog where you can enter a brief description for the calibration kit.

Edit Field (New Calibration Kit submenu)

Displays a dialog where you can edit the value of the highlighted field.

Save (New Calibration Kit submenu)

Saves the custom calibration kit and closes the Calibration Kit Library Editor.

Back (New Calibration Kit submenu)

Closes the Editor without saving the previously entered values.

Edit (Calibration Kit submenu)

Activates the Calibration Kit Library Editor for the highlighted calibration kit.

Delete (Calibration Kit submenu)

Deletes the highlighted calibration kit.

Open (Calibration submenu)

Measures the standard open and saves its response to the calibration data set.

Short (Calibration submenu)

Measures the standard short and saves its response to the calibration data set.

Load (Calibration submenu)

Measures the standard load and saves its response to the calibration data set.

Apply (Calibration submenu)

Saves the current calibration data set and exits the Calibration display.

Clear (Calibration submenu)

Closes the Calibration display without saving the current calibration.

Frequency Soft Keys

The following soft keys are unique to the Frequency menu.

Start Frequency (Frequency submenu)

Displays a dialog where you can set the Start Frequency.

Range	1 MHz to 5999.996 MHz
Default	1 MHz
Saved State	Saved with instrument state

Stop Frequency (Frequency submenu)

Displays a dialog where you can set the Stop Frequency.

Range	1.004 MHz to 6 GHz
Default	6 GHz
Saved State	Saved with instrument state

Center Frequency (Frequency submenu)

Displays a dialog where you can set the Center Frequency.

Range	1.002 MHz to 5.998 GHz
Default	3.0005 MHz
Saved State	Saved with instrument state

Span (Frequency submenu)

Displays a dialog where you can enter the Frequency Span.

Range	0.004 MHz to 6 GHz
Default	5.999 GHz
Saved State	Saved with instrument state

Measure Soft Keys

The following soft keys are unique to the Measure menu.

of Points (Measure submenu)

Displays the # of Points dialog where you set the number of points in a sample.

Range	101 to 10001
Default	201
Saved State	Saved with instrument state
Notes	Set before Calibration. A large number of points will result in a higher fidelity sample, but will also result in a slower sweep time.

IFBW (Measure submenu)

Displays the IFBW dialog where you can set the Intermediate Frequency Bandwidth of the Single Port VNA.

Discrete Values	10, 30, 100, 300 Hz and 1, 3, 10, 30, 100 kHz
Default	10 kHz
Saved State	Saved with instrument state
Notes	Set before calibration. Smaller IFBW increases resolution and lowers noise floor and increases the sweep time.

Trigger Mode (Measure submenu)

Activates a horizontal soft key menu where you can select the desired sweep type.

Discrete Values	Freeze, Single, Auto
Default	Auto

Saved State	Saved with instrument state
Notes	Freeze – Display sweeps stop, allowing further analysis of the captured input signal. Single – Display sweeps once after a key press is performed on the Single soft key. Auto – Display sweeps continuously.

Output Level (Measure submenu)

Displays an Output Level dialog where you can select the RF output level.

Discrete Values	High, Low
Default	High
Saved State	Saved with instrument state
Notes	High – Increase dynamic range, reduce noise. Low – Reduce cross-talk and interference.

Averaging (Measure submenu)

Displays a dialog where you can enable or disable averaging.

Discrete Values	Off, On
Default	Off
Saved State	Saved with instrument state
Notes	Enabling Averaging lowers the noise floor and makes the trace less responsive to sudden changes.

Averaging Factor (Measure submenu)

Displays dialog where you can set the averaging factor.

Range	1 to 999
Default	10
Saved State	Saved with instrument state
Notes	Setting a higher Averaging Factor increases the effect of averaging and decreases responsiveness. Setting a lower Averaging Factor decreases the effect of averaging and increases responsiveness.

Smoothing (Measure submenu)

Displays a dialog where you can enable and disable trace smoothing.

Discrete Values	Off, On
Default	Off
Saved State	Saved with instrument state
Notes	Averages each point with surrounding points to provide a smoother trace. Can result in misleading traces if not used judiciously.

Smoothing Aperture (Measure submenu)

Displays a dialog where you can set the aperture of the smoothing algorithm.

Range	0.010 % to 20.000 %
Default	1.000 %
Saved State	Saved with instrument state

Scale Soft Keys

The following soft keys are unique to the Scale submenu.

Return Loss Ref Value (Scale submenu)

Displays a dialog where you can set the Return Loss Ref Value for the top graticule.

Range	0 to 1000 dB
Default	0 dB
Saved State	Saved with instrument state

Return Loss Scale (Scale submenu)

Displays a dialog where you can set the power scale on the vertical axis.

Range	0.001 to 200 dB/div
Default	1 dB/div
Saved State	Saved with instrument state

Return Loss Auto Scale (Scale submenu)

Automatically scales the vertical axis of the return loss measurement display.

VSWR Ref Value (Scale submenu)

Displays a dialog where you can set a reference value for the top graticule in the VSWR display.

Range	-1000 to 10001
Default	100
Saved State	Saved with instrument state

VSWR Scale (Scale submenu)

Displays a dialog where you change the power scale for VSWR measurement display.

Range	0.001 to 1000
Default	1
Saved State	Saved with instrument state

VSWR Auto Scale (Scale submenu)

Automatically scales the trace on the power or vertical axis.

Trace Soft Keys

The following soft keys are unique to the Trace submenu.

Active Trace (Trace submenu)

Displays a dialog where you can select the active trace during Return Loss or VSWR measurements.

Discrete Values	Return Loss, VSWR
Default	Return Loss
Saved State	Saved with instrument state

Trace Memory

Displays a dialog where you can enable/disable trace memory.

Discrete Values	Off, On
Default	Off
Saved State	Saved with instrument state

Trace Math

Activates a horizontal soft key menu where you can select the trace math to be applied.

Discrete Values	Off, Data+Mem, Data–Mem, Data*Mem, Data/Mem
Default	Off
Saved State	Saved with instrument state
Notes	The following are horizontal menu choices. Off – This selection hides the reference trace and displays the unmodified measured trace res-

	<ul style="list-style-type: none"> ulting from the Display Mode. Data+Mem – Adds data in memory to the current measurement data, useful for simulating the gain of a theoretical amplifier. Data–Mem – Subtracts data in memory from the current measurement data, useful for storing a measured vector error then subtracting it from the device measurement. Data*Mem – Multiplies data in memory to the current measurement data, useful for simulating the gain of a theoretical amplifier. Data/Mem – Divides the current measurement data by the data in memory, useful for comparing measurements of gain or attenuation.
--	---

Marker Soft Keys

The following soft keys are unique to the Marker submenu.

Active Trace (Marker submenu)

Displays a dialog where you can select the active trace during Return Loss or VSWR measurements.

Discrete Values	Return Loss, VSWR
Default	Return Loss
Saved State	Saved with instrument state

Marker Mode (Marker submenu)

Activates a horizontal soft key menu where you can enable and define a marker for the active trace.

Discrete Values	Off, Absolute, Delta
Default	Off
Saved State	Saved with instrument state
Notes	Off – Deactivates markers. Absolute – Displays the absolute amplitude at the marker position. Delta – Displays the difference in amplitude between marker positions and Ref marker position.

Select Marker (Marker submenu)

Activates a horizontal soft key menu where you can select a specific marker.

Discrete Values	1, 2, 3, 4, 5, 6, Ref
Default	1
Saved State	Saved with instrument state
Notes	Ref is only available in Delta marker mode.

Marker Frequency (Marker submenu)

Displays a dialog where you can move the selected marker to a specific frequency.

Range	1 MHz to 6 GHz
Default	1 MHz
Saved State	Saved with instrument state

Marker On/Off (Marker submenu)

Toggles the selected marker on or off.

Marker Search ... (Marker submenu)

Opens a submenu where you can configure marker search settings.

Select Marker (Marker Search submenu)

Activates a horizontal soft key menu where you can select a specific marker.

Discrete Values	1, 2, 3, 4, 5, 6, Ref
Default	1
Saved State	Saved with instrument state
Notes	Ref is only available in Delta marker mode.

Max Peak (Marker Search submenu)

Moves the selected marker to the point representing maximum power on the trace.

Min Valley (Marker Search submenu)

Moves the selected marker to the minimum power point on the trace.

Peak Excursion (Marker Search submenu)

Displays a dialog where you can set the power level threshold that defines a point on the trace as a peak.

Range	0.001 to 1000 dB
Default	1 dB
Saved State	Saved with instrument state
Notes	If pressing the Peak Right or Peak Left buttons do not move the marker, lowering this value will enable their function.

Peak Left (Marker Search submenu)

Moves the selected marker to the next lower frequency point on the trace whose power exceeds the peak excursion threshold.

Peak Right (Marker Search submenu)

Moves the selected marker to the next higher frequency point on the trace whose power exceeds the peak excursion threshold.

Valley Left (Marker Search submenu)

Moves the selected marker to the minimum power point on the trace at a lower frequency than the current marker position.

Valley Right (Marker Search submenu)

Moves the selected marker to the minimum power point on the trace at a higher frequency than the current marker position.

Files Soft Keys

The following soft keys are unique to the Files menu.

Save State/Trace (Files submenu)

Saves the current instrument state or active trace.

Recall (Files submenu)

Opens the VNA-Recall File Table where you can load or delete a saved instrument state or trace.

Load (Recall submenu)

Loads the currently selected saved instrument state or trace.

Delete (Recall submenu)

Deletes the currently selected saved instrument state or trace.

Site ID (Files submenu)

Opens a dialog where you can identify the site associated with a saved instrument state or trace.

GPS Latitude (Files submenu)

Opens a dialog where you can identify the GPS Latitude associated with a saved instrument state or trace as well as a horizontal soft key menu where you can add a decimal point and a minus sign as necessary.

GPS Longitude (Files submenu)

Opens a dialog where you can identify the GPS Longitude associated with a saved instrument state or trace as well as a horizontal soft key menu where you can add a decimal point (.) and a minus sign (–) as necessary.

12 Test Mode Soft Keys

The Test Mode menu provides user presets, optional dedicated test modes for advanced transmission protocols, optional AutoTune automated test and alignment software for manufacturer-specific radios, and AutoScript, an internal monitor and control application. This chapter contains detailed descriptions of the soft keys accessible in each menu. Each soft key is defined, along with its range, discrete, default, and saved state values.

"Presets Soft Keys" on the next page enable loading, saving, and creating custom presets to expedite testing.

"Test Mode Soft Keys" on page 595 offer access to many digital mobile radio formats with links to their individual soft key references.

"AutoTune Soft Keys" on page 790 enable an optional automated test and alignment software application for manufacturer-specific radios.

"AutoScript Soft Keys" on page 799 enable monitor and control (M&C) script execution from within the R8200.

Presets Soft Keys

The Presets menu allows you to load, save, and create custom presets to expedite testing. Presets are a convenient tool for storing and recalling complex analyzer configurations. They are especially useful when several unique operating configurations are required in a test environment. Presets ensure a fast and accurate method of configuring the analyzer for multiple test applications. To save time and avoid errors, the R8200 can store over 100 preset configurations.

Save Configuration As (Presets submenu)

Displays a dialog where you can name a preset and store it.

Range	A-Z and 0-9
Saved State	Saved with instrument state
Notes	Presets are persistent across system cycles. If any Presets are present, they can be highlighted for further action using the arrow keys or the tuning knob. If no presets are present, the analyzer powers up in the default factory configuration. Otherwise, the last Preset loaded or saved before the unit was powered down is used to configure the analyzer. Names cannot have spaces or blanks between characters. Pressing Enter adds the new Preset to the list while Esc cancels the entry.

Load Selected Preset (Presets submenu)

Loads the highlighted preset and configures the analyzer per the preset file.

Notes	The selected Preset becomes the new default configuration on power up unless a different one is chosen or saved before powering down the analyzer.
-------	--

Save As Selected Preset (Presets submenu)

Saves the current parameter configuration to the highlighted preset.

CAUTION

This will overwrite the highlighted preset without prompting the user.

Load Factory Configuration (Presets submenu)

Configures the analyzer per the factory default settings.

Notes	This is the default on power up unless a different Preset is loaded or saved before powering down the analyzer.
-------	---

Delete Selected Preset (Presets submenu)

Deletes the highlighted preset.

Notes	A prompt will be displayed to confirm you want to delete the highlighted preset.
-------	--

Test Mode Soft Keys

Activates a horizontal soft key menu where you can select from a variety of test modes and applications including Standard (Monitor Mode), DMR, Project 25, P25 Trunk, NXDN, NXDN™ Trunk, TETRA Base Station, TETRA DMO, TETRA TMO, dPMR, P25 II, PTC-ITCR, PTC-ACSES, and AVIONICS.

Standard

Activates Monitor Mode. Refer to ["8 Monitor Mode Soft Keys" on page 351](#) for a complete soft key reference.

DMR

Activates the DMR Test Mode. Refer to ["DMR Zone Soft Keys" on page 597](#) for a complete soft key reference.

Project 25

Activates the Project 25 Test Mode. Refer to ["PROJECT 25 Zone Soft Keys" on page 616](#) for a complete soft key reference.

P25 Trunk

Activates the P25 Trunk Test Mode. Refer to ["P25 Trunk Zone Soft Keys" on page 639](#) for a complete soft key reference.

NXDN™

Activates the NXDN™ Test Mode. Refer to ["NXDN™ Zone Soft Keys" on page 656](#) for a complete soft key reference.

NXDN™ Trunk

Activates the NXDN™ Trunk Test Mode. Refer to ["NXDN™ Trunk Zone Soft Keys" on page 670](#) for a complete soft key reference.

TETRA Base Station

Activates the TETRA Base Station Test Mode. Refer to ["TETRA Base Station Test Mode Soft Keys" on page 680](#) for a complete soft key reference.

TETRA DMO

Activates the TETRA DMO Test Mode. Refer to **"TETRA DMO Zone Soft Keys" on page 696** for a complete soft key reference.

TETRA TMO

Activates the TETRA TMO Test Mode. Refer to **"TETRA TMO Test Mode Soft Keys" on page 708** for a complete soft key reference.

dPMR

Activates the dPMR Test Mode. Refer to **"dPMR Zone Soft Keys" on page 730** for a complete soft key reference.

P25 II

Activates the P25 II Test Mode. Refer to **"P25 II Zone Soft Keys" on page 743** for a complete soft key reference.

PTC-ITCR

Activates the PTC-ITCR Test Mode. Refer to **"PTC-ITCR Zone Soft Keys" on page 759** for a complete soft key reference.

PTC-ACSES

Activates the PTC-ACSES Test Mode. Refer to **"PTC-ACSES Zone Soft Keys" on page 764** for a complete soft key reference.

AVIONICS

Activates the AVIONICS Test Mode. Refer to **"AVIONICS Test Mode Soft Keys" on page 774** for a complete soft key reference.

DMR Zone Soft Keys

This section contains detailed descriptions of the soft keys accessible in the DMR Zone during transmitter testing with the R8200 in Monitor Mode, and receiver testing with the R8200 in Generate Mode. Each DMR soft key is defined, along with its range, discrete, default, and saved state values.

"DMR Zone Soft Keys for Transmitter Test" on the next page includes the parameters associated with testing the DMR radio's transmitter with the R8200 in Monitor Mode. For standard Monitor Mode soft key definitions, see **"8 Monitor Mode Soft Keys" on page 351**.

"DISPLAY Zone Soft Keys for DMR Transmitter Test" on page 601 includes the parameters associated with specialized display configurations for quick visual verification of DMR transmitter performance. For standard DISPLAY Zone soft key definitions, see **"DISPLAY Zone Soft Keys for Monitor Mode" on page 383**.

"METER Zone Soft Keys for DMR Transmitter Test" on page 607 includes the parameters associated with specialized metering configurations offering focused presentations of basic RF and baseband DMR transmitter characteristics. For standard METER Zone soft key definitions, see **"METER Zone Soft Keys for Monitor Mode" on page 401**.

"DMR Zone Soft Keys for Receiver Test" on page 608 includes the parameters associated with testing the DMR radio's receiver with the R8200 in Generate Mode. For standard Generate Mode soft key definitions, see **"9 Generate Mode Soft Keys" on page 411**.

DMR Zone Soft Keys for Transmitter Test

These tests are performed with the R8200 in Monitor Mode. During DMR transmitter tests, the DMR Zone contains the controls for the DMR receiver.

Voice Loopback (DMR submenu)

Activates a horizontal soft key menu where you can select the Voice Loopback mode (U.S. patent 5703479).

Discrete Values	Off, Play, Record, Record & Play
Default	Off
Saved State	Saved with instrument state
Notes	<p>Only available when UUT Configuration is set to MS Test.</p> <p>Once enabled, the R8200 automatically records an input message when the radio under test transmits a signal above the squelch level setting. A Voice Loop progress bar in the DMR Zone is bold when Voice Loopback is enabled. The maximum length of the recording is 10 seconds, and a light green progress bar shows the recording's progress. The recording continues if the transmission is longer, but only the most recent is retained. When the radio is un-keyed, the R8200 automatically switches to Generate Mode and transmits the captured input message back to the radio. The position of the played back recording is displayed with a dark green progress bar. When the recorded message has been played and a three-second settling delay has passed, the analyzer automatically switches back to Monitor Mode so another message can be recorded. This provides a quick end-to-end test of the radio transmitter and receiver. Voice Loopback can also be used to quickly verify basic functionality of an encrypted message. The power Input Level of the received message is readjusted to maintain the power Output Level of the transmitted message.</p> <p>Voice Loopback overrides the Color Code (CC), Modulation Mode, and Test Pattern settings during playback. The R8200 captures and re-sends the Color Code, destination ID (address), and</p>

	<p>call type sent by the radio. For the radio to audibly reproduce the message, the radio must be set to a Group Call or an All Call channel.</p> <p>Off – Stops a recording or playback and disables the feature; the progress bar is grayed out. The last recording is preserved for the remainder of the session; it is lost if the R8200 is power cycled.</p> <p>Record (Monitor Mode only) – Disables the automatic switch to Generate Mode and subsequent playback. The last recording is automatically erased when a new input message is detected.</p> <p>Play (Generate Mode only) – Repeatedly plays and rewinds the last recorded message; speech recorded from a transmitting radio under test should be heard from its receiver if the radio is operating properly. This setting disables the automatic switch to Monitor Mode and subsequent recording.</p> <p>Record & Play – Automatically switches from Monitor Mode to Generate Mode to play a recording. It also switches from Generate Mode to Monitor Mode to make a new recording.</p>
--	--

Mon Sync Pattern (DMR submenu)

Activates a horizontal soft key menu where you can select the DMR Mon Sync Pattern.

Discrete Values	MS Sourced Voice, MS Sourced Data, TDMA slot 1 Voice, TDMA slot 1 Data, TDMA slot 2 Voice, TDMA slot 2 Data
Default	MS Sourced Voice
Saved State	Saved with instrument state
Notes	BS Sourced Voice for a base station/repeater, or MS Sourced Voice for a portable/mobile station.

Copy CC to Generator (DMR submenu)

Sets the R8200 generator to use the last Color Code that was received in Monitor Mode.

Burst (DMR submenu)

Activates a horizontal soft key menu where you can select from a choice of six super frame bursts to display radio transmitter quality measurements.

Discrete Values	A, B, C, D, E, F
Default	A
Saved State	Saved with instrument state
Notes	The following measurements are made from the selected burst: Input Level, Constellation, Symbol Deviation, FSK Error, and Magnitude Error.

BER Test (DMR submenu)

Activates a horizontal soft key menu where you can control the operating state of Bit Error Rate Testing.

Discrete Values	Stop, Start
Default	Stop
Saved State	Saved with instrument state
Notes	This bit error rate test checks the modulation, encoding, and timing of the transmit signal during the data transmission period. When the BER Test is running, the radio transmitter under test must be placed into a Test Diagnostic Mode with the correct TX test pattern selected using the manufacturer's Radio Service Software (RSS) / MOTOTRBO™ Tuner. The test is done at nominal power with the radio transmitting the 0.153 super frame test pattern into the service monitor. (It is acceptable to have an attenuator between the radio under test and the service monitor.) BER test results, the percentage of bit differences between the 0.153 pattern and the bits of the synchronized TDMA slot of the received signal, are shown in the DMR Zone in the BER field.

UUT Configuration (DMR submenu)

Activates a horizontal soft key menu where you can select one of three UUT Configuration options.

Discrete Values	MS Test, BS Test, Repeater Live
Default	MS Test
Saved State	Saved with instrument state

DISPLAY Zone Soft Keys for DMR Transmitter Test

The DISPLAY Zone offers specialized displays during DMR transmitter testing with the R8200 in Monitor Mode. Their associated soft keys are described below.

Select Display (DISPLAY Zone menu)

Pressing this soft key activates a horizontal soft key menu where you can select the display mode.

Discrete Values	Spec An, Eye Diagram, Power Profile, Distribution Plot, Analysis Details, Protocol Details
Default	Spec An
Saved State	Saved with instrument state
Notes	Spec An is only available in Monitor Mode.

Spectrum Analyzer (DISPLAY Zone menu)

For Spectrum Analyzer soft key descriptions, see "[Spectrum Analyzer Soft Keys](#)" on page 525.

Eye Diagram (DISPLAY Zone menu)

Provides a visual display of the received signal and overlays the modulation response during two symbol periods over the four target crossing points for an ideal signal.

Saved State	Saved with instrument state
Notes	The Eye Diagram can indicate whether a transmitter has significant unbalances or offsets in the modulation circuitry by noting how tightly grouped the waveform is around the crossing points. Ensure that the Monitor Modulation Type in the Test Mode Zone (e.g., DMR Zone) is set for the expected receive signal in order to establish the appropriate symbol timing used to position the diagram on the horizontal axis.

Display Mode (Eye Diagram submenu)

When the display is set to Eye Diagram, pressing this soft key activates a horizontal soft key menu where you can select the Eye Diagram display mode.

Discrete Values	Normal, Fade Away
Default	Normal
Saved State	Saved with instrument state
Notes	Normal – Display updates continuously. Fade Away – Similar to the Persistence Mode on an Oscilloscope. The intensity of each trace fades away or decays as new traces are received. The effect is to intensify the display in the area where the waveform spends most of its time. Whenever the Display mode is changed, the R8200 reconfigures the presentation. This process takes approximately 10 seconds and is complete when the new setting appears in the Display mode field.

Power Profile (DISPLAY Zone menu)

Provides a power versus time plot of the transmitter.

Notes	<p>The display is useful in assuring that near-far situations will not result in co-channel inter-slot interference on the alternate or non-transmission slot and that the power level will be adequate for acceptable BER performance.</p> <p>The scaling and position of the vertical power axis can be adjusted to inspect greater range or detail.</p> <p>The horizontal axis can be changed to view one or both slots including the additional ramp up/down time. Display functions and markers are available for advanced analysis.</p> <p>See the Technical Specification: ETSI TS 102 361-1 Electromagnetic compatibility and Radio Spectrum Matters (ERM); Digital Mobile Radio (DMR) Systems; Part 1: "DMR Air Interface (AI) protocol," section 10.2.3 Burst timing on page 114.</p>
-------	---

Select View (Power Profile submenu)

When the display is set to Power Profile, pressing this soft key opens a horizontal soft key menu where you can select the slot(s) to view.

Discrete Values	Current, Alternate, Both
Default	Current
Saved State	Saved with instrument state
Notes	Although slots are alternating 30 milliseconds, the profile for a slot is 30.5 ms, divided into three regions for ramp-up (1.5 ms), burst (27.5 ms), and ramp-down (1.5 ms).

	<p>Current – Provides the horizontal axis –0.25 ms to 30.25 ms with slot from 0 to 30 ms.</p> <p>Alternate – Provides the horizontal axis 29.75 ms to 60.25 ms with slot from 30 to 60 ms.</p> <p>Both – Provides the horizontal axis –0.25 ms to 60.25 ms with slots from 0 to 30 and 30 to 60 ms.</p> <p>Ramp times for a slot overlap the adjacent slots by 0.25 milliseconds.</p>
--	---

Vertical Maximum (Power Profile submenu)

When the display is set to Power Profile, pressing this soft key opens the Vertical Scale dialog where you can adjust the maximum level for the top line of the vertical scale of the display.

Range	–120 dBm to +60 dBm in 1 dB increments
Default	50 dBm
Saved State	Saved with instrument state

Vertical Scale (Power Profile submenu)

When the display is set to Power Profile, pressing this soft key opens a horizontal soft key menu where you can select the vertical scale resolution for the display's major grid lines.

Discrete Values	10 dB/div, 5dB/div, 2 dB/div, 1 dB/div
Default	10 dB/div
Saved State	Saved with instrument state

Display Mode (Power Profile submenu)

When the display is set to Power Profile, pressing this soft key opens a horizontal soft key menu where you can select the display mode.

Discrete Values	Normal, Freeze, Max Hold, Average
Default	Normal
Saved State	Saved with instrument state
Notes	<p>Normal – Display updates continuously.</p> <p>Freeze – Provides a snapshot of the current display indication and stops additional updates. In Freeze Mode, the R8200 reacquires data and updates the display whenever Center Marker or Center Peak is pressed.</p> <p>Max Hold – Enables the display to retain the highest peak signal amplitudes measured during successive sweeps.</p> <p>Average – Displays signal amplitudes as a rolling average of the peak amplitudes measured on each successive sweep. The average consists of one to five sweeps, shown beside the mode indication.</p>

Marker Mode (Power Profile submenu)

When the display is set to Power Profile, pressing this soft key activates a horizontal soft key menu where you can select the Marker Mode.

Discrete Values	Off, Absolute, Delta, Delta dBm
-----------------	---------------------------------

Default	Off
Saved State	Saved with instrument state
Notes	<p>Off – Deactivates markers.</p> <p>Absolute – Displays the frequency and absolute signal amplitude for each marker selected.</p> <p>Delta – Displays the frequency and amplitude difference between each pair of markers selected.</p> <p>Delta dBm – Displays the amplitude difference between each pair of markers selected.</p> <p>Depending on the installed options, up to four markers can be enabled and selected for positioning.</p>

Toggle Marker (Power Profile submenu)

When the display is set to Power Profile, pressing this soft key cycles through the available markers to select a marker for repositioning along the trace using the horizontal arrow keys.

Distribution Plot (DISPLAY Zone menu)

Depicts the spread of symbols over time about each center. There are no configurable parameters for the distribution plot. For more information, see "[Distribution Plot](#)" on page 158.

Analysis Details (DISPLAY Zone menu)

Displays the measured deviation points for each data symbol and the Magnitude error for each data symbol. The nominal deviation points for each data symbol are provided on the screen as reference.

Protocol Details (DISPLAY Zone menu)

Details of the configuration during performance verification testing for documentation purposes.

METER Zone Soft Keys for DMR Transmitter Test

The METER Zone offers specialized meters during DMR transmitter testing with the R8200 in Monitor Mode. Their associated soft keys are described below.

Constellation (METER Zone menu)

Provides a visual representation of overall transmitter operation.

Saved State	Saved with instrument state															
Notes	<p>DMR radios broadcast voice and data using four frequency shift deviations of the carrier to represent symbols containing two data bits. Four red tick marks on the display represent the expected locations for the deviation states when the radio is transmitting data bit symbols using the modulation. White bars show the actual deviation measurement at symbol decision times. A tighter grouping around the red tick marks indicates more accurate transmitter performance.</p> <p>The nominal deviation points for each data symbol are as follows:</p> <table border="1"><thead><tr><th>Bits</th><th>Symbol</th><th>Deviation</th></tr></thead><tbody><tr><td>01</td><td>+3</td><td>+1944 Hz</td></tr><tr><td>00</td><td>+1</td><td>+648 Hz</td></tr><tr><td>10</td><td>-1</td><td>-648 Hz</td></tr><tr><td>11</td><td>-3</td><td>+1944 Hz</td></tr></tbody></table>	Bits	Symbol	Deviation	01	+3	+1944 Hz	00	+1	+648 Hz	10	-1	-648 Hz	11	-3	+1944 Hz
Bits	Symbol	Deviation														
01	+3	+1944 Hz														
00	+1	+648 Hz														
10	-1	-648 Hz														
11	-3	+1944 Hz														

DMR Zone Soft Keys for Receiver Test

These tests are performed with the R8200 in Generate Mode. During DMR receiver tests, the DMR Zone contains controls for the DMR transmitter.

Voice Loopback (DMR submenu)

Activates a horizontal soft key menu where you can select the Voice Loopback mode.

Discrete Values	Off, Play, Record & Play
Default	Off
Saved State	Saved with instrument state
Notes	<p>Only available when UUT Configuration is set to MS Test.</p> <p>Voice Loopback overrides the Color Code (CC), Modulation Mode, and Test Pattern settings during playback. The R8200 captures and resends the Color Code, destination ID (address), and call type sent by the radio. For the radio to audibly reproduce the message, the radio must be set to a Group Call or an All Call channel.</p> <p>Off – stops a recording or playback and disables the feature; the progress bar is grayed out. The last recording is preserved for the remainder of the session; it is lost if the R8200 is power cycled.</p> <p>Play – (Generate Mode only) repeatedly plays and rewinds the last recorded message; speech recorded from a transmitting radio under test should be heard from its receiver if the radio is operating properly. This setting disables the automatic switch to Monitor Mode and subsequent recording.</p> <p>Record & Play – automatically switches from Monitor Mode to Generate Mode to play a recording. It also switches from Generate Mode to Monitor Mode to make a new recording.</p>

Color Code (DMR submenu)

Displays a dialog where you can set the DMR Color Code.

Range	0 to 15
Default	0
Saved State	Saved with instrument state
Notes	Color Code is digital ID information equivalent to CTCSS/PL and CDCSS/DPL of analog FM radio systems.

Modulation Mode (DMR submenu)

Activates a horizontal soft key menu where you can enable and disable DMR modulation.

Discrete Values	Off, Continuous
Default	Off
Saved State	Saved with instrument state

Test Pattern (DMR submenu)

Activates a horizontal soft key menu where you can select the DMR Test Pattern.

Discrete Values	1031 Hz Tone, Calibration (0.153 1%), 0.153, Silence, PN9, BS Busy, BS Idle
-----------------	---

Default	1031 Hz Tone
Saved State	Saved with instrument state
Notes	<p>This field specifies the DMR-compliant test pattern generated by the R8200 to assess voice performance or test data transmission accuracy using BER measurements. When performing the BER test, the radio receiver under test must be placed in a Test Diagnostic Mode with the correct RX test pattern selected using the manufacturer's Radio Service Software (RSS) / MOTOTRBO™ Tuner to enable it to calculate BER internally. The calculated BER is then displayed by the radio or on the computer (as is the case for MOTOTRBO™ Tuner). For sensitivity tests, the R8200 can transmit a super frame test pattern, 0.153 (V.52) for example, over its entire output power level range. This provides a measurement of the reference sensitivity (1% or 5% BER) for the radio.</p> <p>All patterns have the all-call destination with broadcast service option as a convenience to eliminate the need to reprogram the radio's ID.</p> <p>A horizontal submenu provides the following DMR compliant patterns:</p> <p>1031 Hz Tone – A predefined super frame test pattern compatible with digital vocoder type AMBE+2™ that produces a 1031 Hz tone at the speaker of the receiver vocoder. It can be used to quickly check audio performance in the field.</p> <p>Calibration (0.153 1%) – A test pattern transmitted at the defined power level. –60 dBm for example, is used to verify internal BER calculations are operating correctly. The 1% BER super frame test pattern changes the value of every 100th 0.153 information bit and the very last bit to yield 13 bit errors out of 1296 0.153 information bits (precisely 1.0030864%).</p> <p>0.153 – A super frame test pattern based on ITU-T 0.153 (formerly CCITT V.52) used to perform BER calculations.</p> <p>Silence – A predefined super frame test pattern compatible with digital vocoder type AMBE+2™ that results in a silent output at the receiver vocoder.</p> <p>PN9 – A test pattern with ITU-T 0.153 continuously inserted into DMR burst payloads to perform BER calculations for DMR Tier III radios.</p>

	<p>BS Busy – Emulates a base station that is fully occupied. If the radio is programmed to be compliant, when keyed the radio should report Base Station Busy. If not programmed to be compliant, the radio will transmit regardless of the base station busy signal.</p> <p>BS Idle - The radio searches for a signal from the base station before it will transmit. In Generate or Duplex Mode, the R8200 transmits two time slots, mimicking a base station that has no traffic on it. When PTT is pressed on the radio, the radio will transmit to the R8200. Without this test pattern the radio will not transmit.</p>
--	--

UUT Configuration (DMR submenu)

Activates a horizontal soft key menu where you can select one of three UUT Configuration options.

Discrete Values	MS Test, BS Test, Repeater Live
Default	MS Test
Saved State	Saved with instrument state
Notes	<p>MS Test – Use this selection when testing a user device (portable or mobile)</p> <p>BS Test – Use this selection when testing a base station or repeater while the BS is under control of test and diagnostic software.</p> <p>Repeater Live (option must be enabled) – Use this selection when testing a DMR repeater configured for normal operating mode. The Freedom DMR Live Repeater Test Mode configures the test analyzer to transmit a “wake” up burst at the repeater, synchronize to the repeater transmission and then transmit a selected test pattern into a selected slot. The analyzer will then perform all standard measurements on the repeated transmission. After the analyzer is synced to the repeater the technician can switch slots and adjust power output of analyzer to determine RX sensitivity of repeater.</p>

Encode Configuration (DMR submenu)

When the UUT Configuration is set to Repeater Live, pressing this soft key opens the Transmit Configuration (Encoding) Table where you can enter Radio/Source ID, emergency, priority, slot number, slot to analyze, and call/target address.

Radio/Source ID (Encode Configuration submenu)

When the UUT Configuration is set to Repeater Live, pressing this soft key opens the Radio/Source ID dialog where you can set the Source ID transmitted in test patterns.

Range	1 to 16777216
Default	16777016
Saved State	Saved with instrument state

Emergency (Encode Configuration submenu)

When the UUT Configuration is set to Repeater Live, pressing this soft key opens the Emergency dialog where you can enable or disable the “Emergency” flag in the DMR standard Service Options field.

Discrete Values	Off, On
Default	Off
Saved State	Saved with instrument state
Notes	Details of this field can be found in Table 7.11 of ETSI TS 102 361-2 v2.4.1 (2017-10). “Service Options” is available in the standard but it is not mandatory for use. Manufacturers may utilize propriety signaling methods for “Emergency” notifications. Check with the manufacture of the unit under test for the validity of the use of this feature.

Priority (Encode Configuration submenu)

When the UUT Configuration is set to Repeater Live, pressing this soft key opens the Priority dialog where you can select the priority level in the service options field.

Discrete Values	0, 1, 2, 3
Default	0
Saved State	Saved with instrument state
Notes	Where 0 = No priority and 3 = highest priority. Details of this field can be found in Table 7.11 of ETSI TS 102 361-2 v2.4.1 (2017-10). Service Options is available in the standard but its use is not mandatory. Manufacturers may utilize propriety signaling methods for Priority notifications. Check with the manufacture of the unit under test for the validity of the use of this feature.

Slot # (Encode Configuration submenu)

When the UUT Configuration is set to Repeater Live, pressing this soft key opens the Slot # dialog where you can select the slot to transmit into when testing with a repeater under Live Repeater Test Mode.

Discrete Values	1, 2
Default	1
Saved State	Saved with instrument state

Slot to Analyze (Encode Configuration submenu)

When the UUT Configuration is set to Repeater Live, pressing this soft key opens the Slot to Analyze dialog where you can select a slot for analysis.

Discrete Values	0, 1, 2
Default	0
Saved State	Saved with instrument state
Notes	<p>0 – Automatic selection in which the analyzer will make measurements on same slot as in sync with based on “monitor sync pattern”. This is the recommended setting.</p> <p>When not set to 0 (Auto) the analyzer will sync to a slot with the expected monitor sync pattern then look to see if that slot matches the desired slot to analyze. If so, it will do nothing. If not, the analyzer will drop sync and attempt to sync to the opposite slot.</p> <p>Use this parameter only if both slots have the same “monitor sync pattern” and you want to see a specific slot. If the “monitor sync pattern” is only in ONE slot, and it does not match the requested slot to analyze, then the unit will repeatedly drop in and out of sync.</p>

Target/Call Address (Encode Configuration submenu)

When the UUT Configuration is set to Repeater Live, pressing this soft key opens the Target/Call Address dialog where you can set the Call or Group ID in the transmission of the test pattern.

Range	0 to 16777215
Default	16777215 (All Call)
Saved State	Saved with instrument state

Reset to Defaults (Encode Configuration submenu)

When the UUT Configuration is set to Repeater Live, pressing this soft key resets all selections in the Encode Configuration Table to default values.

PROJECT 25 Zone Soft Keys

This section contains detailed descriptions of the soft keys accessible in the PROJECT 25 Zone during transmitter testing with the R8200 is in Monitor Mode, and receiver testing with the R8200 is in Generate or Duplex Mode. Each Project 25 soft key is defined, along with its range, discrete, default, and saved state values.

"PROJECT 25 Zone Soft Keys for Transmitter Test" on the next page includes the parameters associated with testing the Project 25 radio's transmitter with the R8200 in Monitor Mode. For standard Monitor Mode soft key definitions, see **"8 Monitor Mode Soft Keys" on page 351**.

"DISPLAY Zone Soft Keys for PROJECT 25 Transmitter Test" on page 620 includes the parameters associated with specialized display configurations for quick visual verification of Project 25 transmitter performance. For standard DISPLAY Zone soft key definitions, see **"DISPLAY Zone Soft Keys for Monitor Mode" on page 383**.

"METER Zone Soft Keys for PROJECT 25 Transmitter Test" on page 622 includes the parameters associated with specialized metering configurations offering focused presentations of basic RF and baseband Project 25 transmitter characteristics. For standard METER Zone soft key definitions, see **"METER Zone Soft Keys for Monitor Mode" on page 401**.

"PROJECT 25 Zone Soft Keys for Receiver Test" on page 628 includes the parameters associated with testing the Project 25 radio's receiver with the R8200 in Generate or Duplex Mode. For standard Generate Mode soft key definitions, see **"9 Generate Mode Soft Keys" on page 411**. For standard Duplex Mode soft key definitions, see **"10 Duplex Mode Soft Keys" on page 461**.

PROJECT 25 Zone Soft Keys for Transmitter Test

These tests are performed with the R8200 in Monitor or Duplex Mode. During Project 25 transmitter tests, the PROJECT 25 Zone contains controls for the Project 25 receiver.

Mon Test Pattern (Project 25 submenu)

Activates a horizontal soft key menu where you can select the Project 25 monitor test pattern.

Discrete Values	1011 Hz Tone, Calibration (Tone 5%), Standard Tx (0.153/V.52), Silence, Modified 1011 Hz
Default	1011 Hz Tone
Saved State	Saved with instrument state
Notes	<p>1011 Hz Tone – Standard tone framed test pattern of the 1011 Hz vocoder tone.</p> <p>Calibration (Tone 5%) – Test pattern derived from the standard 1011 Hz Tone test pattern to verify BER measurements are operating correctly. Every 20th bit is inverted to yield 172 errors out of 3456 bits resulting in a 4.976852% BER.</p> <p>Standard Tx (0.153/V.52) – Standard transmitter test pattern of continuously repeating 511-bit pseudo random number sequences based on ITU-T 0.153 (formerly CCITT V.52).</p> <p>Silence – Framed test pattern for silence at the vocoder.</p> <p>Modified 1011 Hz – Provides 0% BER when testing a live base station.</p>

Monitor Modulation Type (Project 25 submenu)

Activates a horizontal soft key menu where you can select the Project 25 monitor modulation type.

Discrete	C4FM, LSM, WCQPSK
----------	-------------------

Values	
Default	C4FM
Saved State	Saved with instrument state
Notes	The type specified is used in the DISPLAY Zone to enable selection of the Constellation Plot for complex modulation types (LSM and WCQPSK); it is also used by the Eye Diagram for horizontal positioning.

Reset Symbol Rate Error (Project 25 submenu)

Resets the R8200's symbol rate error.

Notes	This is necessary after the input signal changes such that it is discontinuous from when the measurement was started.
-------	---

BER Test (Project 25 submenu)

Activates a horizontal soft key where you can stop or start bit error rate testing.

Discrete Values	Stop, Start
Default	Stop
Saved State	Saved with instrument state
Notes	When performing the BER test, the radio transmitter under test must be placed in a test diagnostic mode using the manufacturer's Radio Service Software (RSS). The transmission is compared against the Test Pattern specified in the P25 submenu. BER test results are shown as an error in % in the PROJECT 25 Zone.

Voice Loopback (Project 25 submenu)

Opens the Voice Loopback menu. Pressing this button a second time displays a dialog where you can enable and disable Voice Loopback.

Discrete Values	Off, On
Default	Off
Saved State	Saved with instrument state
Notes	When performing the BER test, the radio transmitter under test must be placed in a test diagnostic mode using the manufacturer's Radio Service Software (RSS). The transmission is compared against the Test Pattern specified in the P25 submenu. BER test results are shown as an error in % in the PROJECT 25 Zone.

Play Last Recording (Voice Loopback submenu)

Pressing the soft key places the R8200 in Generate Mode and modulates the carrier with the most recently recorded voice channel data after the Voice Loopback function is enabled.

Saved State	Saved with instrument state
Notes	This selection appears only after a recording has been made. The total transmission time is equal to the length of recorded data, and a bar graph indicates the remaining transmission time during playback. Speech recorded from a transmitting P25 radio under test should be heard from its receiver if the radio is operating properly.

Record Duration (Voice Loopback submenu)

Sets the maximum length of a voice recording.

Range	1 to 10 s
Default	10 s
Saved State	Saved with instrument state
Notes	The recording continues if the transmission is longer than the duration, but only the most recent is retained.

Copy NAC to Generator (Project 25 submenu)

Sets the R8200 voice frame encoder's Network Access Code to the decoder's received NAC for transmission back to a radio under test so that the R8200 can receive transmissions from it.

DISPLAY Zone Soft Keys for PROJECT 25 Transmitter Test

The DISPLAY Zone offers specialized displays during Project 25 transmitter testing with the R8200 in Monitor Mode. Their associated soft keys are described below.

For Spectrum Analyzer and Oscilloscope soft key descriptions, see ["Spectrum Analyzer Soft Keys" on page 525](#) and ["Oscilloscope Soft Keys" on page 539](#).

Select Display (DISPLAY Zone menu)

Pressing this soft key activates a horizontal soft key menu where you can select the display mode.

Discrete Values	Spec An, Oscilloscope, Bar Graphs, Eye Diagram, Voice Frame Decode, Constellation Plot, Distribution Plot
Default	Spec An
Saved State	Saved with instrument state
Notes	Spec An, Bar Graphs, Eye Diagram, Voice Frame Decode, Constellation Plot, and Distribution Plot are only available in Monitor and Duplex Mode.

Spectrum Analyzer (DISPLAY Zone menu)

For Spectrum Analyzer soft key descriptions, see ["Spectrum Analyzer Soft Keys" on page 525](#).

Eye Diagram (DISPLAY Zone menu)

For Eye Diagram soft key descriptions, see ["Eye Diagram \(DISPLAY Zone menu\)" on page 602](#).

Voice Frame Decode (DISPLAY Zone menu)

Opens the Voice Frame Decode menu where you can observe the decoded data from the P25 embedded signaling.

Notes	Rotate the tuning knob CCW to view the frame history in the DISPLAY Zone. Frame # indicates the position. Clockwise exits history. The Voice Frame fields are from the header word and interspersed status symbols. For more information, see "Voice Frame Decode" on page 173 .
-------	---

Constellation Plot (DISPLAY Zone menu)

Displays the EVM measurement and a graph showing the symbol constellation on the complex I/Q plane, a visual representation of overall transmitter operation when Monitor Modulation Type is complex (e.g., LSM or WCQPSK).

Constellation Display Mode (Constellation Plot submenu)

Activates a horizontal soft key menu where can select the Constellation Display presentation.

Discrete Values	Symbols, Samples, Trajectories
Default	Trajectories
Saved State	Saved with instrument state

Notes	<p>Symbols – Displays the samples at the optimal symbol decision times as white dots. Correct transmitter operation should group them tightly around the eight ideal phase points.</p> <p>Samples – In addition to the symbol points, samples between symbol times three times their number are displayed as blue dots.</p> <p>Trajectories – Instead of sample points, blue lines connect adjacent samples to approximate the continuous transmitter output throughout the burst.</p>
-------	--

Distribution Plot (DISPLAY Zone menu)

Displays a graph showing the distribution of symbol deviations of the received signal grouped into frequency bins of 10 Hz or less (i.e., the frequency offset versus the rate of occurrence of that frequency). Each plot consists of at least a second of the most current data available. The protocol consists of four symbol values (-3, -1, +1, +3) at proportional carrier deviations. The four ideal symbol deviations are labeled at grid lines. Additional grid lines half way between labels divide the plot into four equal regions and mark the thresholds where symbol decisions change from one to the other. For example, in low power conditions, noise may cause a symbol's deviation to appear in the adjacent region, thus causing a bit error.

All distribution amounts are displayed by automatic adjustment of the vertical axis scaling to show the full amount of symbols falling into each bin. Distribution amounts are the percentage of the number of symbols whose deviation falls within that point's frequency bin based on the number of symbols in the analysis population. The better a signal is, the more symbols will actually land in the ideal bin to increase its percentage. Deviations that are past the graph edge limits (e.g., for noise if no signal exists) are collected and shown in the bin at the limit.

METER Zone Soft Keys for PROJECT 25 Transmitter Test

The METER Zone offers specialized meters during PROJECT 25 transmitter testing with the R8200 in Monitor Mode. Their associated soft keys are described below.

Power Meter (METER Zone menu)

Opens the Power Meter display and submenu.

Range (Power Meter submenu)

When the meter is set to Power Meter, pressing this soft key activates a horizontal soft key menu where you can select the power meter range.

Discrete Values	5, 10, 50, 150 W
Default	50 W
Saved State	Saved with instrument state
Notes	For best accuracy, disable the Pre-amplifier in Monitor Mode and set the Gen Port in Generate Mode to RF In/Out.

Voltmeter (METER Zone menu)

Opens the Voltmeter display and submenu.

Select Voltmeter Mode (Voltmeter submenu)

When the meter is set to Voltmeter, pressing this soft key activates a horizontal soft key menu where you can select the voltage mode for the Voltmeter.

Discrete Values	AC Volts, DC Volts
Default	AC Volts
Saved State	Saved with instrument state
Notes	AC Volts measures AC voltage applied to the Meter In port. The dBm computation assumes an impedance of 600Ω.

Coupling (Voltmeter submenu)

When the meter is set to Voltmeter, pressing this soft key activates a Coupling dialog menu where you can select the input voltage coupling.

Discrete Values	DC, AC
Default	DC
Saved State	Saved with instrument state

AC Range (Voltmeter submenu)

When the meter is set to Voltmeter, pressing this soft key activates a horizontal soft key menu where you can select the power meter AC voltage range.

Discrete Values	Auto, 1 V, 10 V, 70 V
Default	Auto
Saved State	Saved with instrument state
Notes	The range on AC and DC must be 1 or 10 Volts to use 600 Ohm Input Impedance.

Set dBr Reference (Voltmeter submenu)

When the meter is set to Voltmeter and Voltmeter mode is set to AC, pressing this soft key sets a reference input voltage.

Notes	When selected, dBm measurements are frozen, and a dBr indicator appears. The dBr indicates the normalized measurement between the reference input voltage and the current input voltage.
-------	--

Clear dBr Reference (Voltmeter submenu)

When the meter is set to Voltmeter and Voltmeter mode is set to AC, pressing this soft key clears the dBr reference input voltage.

Voltage Units (Voltmeter submenu)

When the meter is set to Voltmeter, pressing this soft key activates a horizontal soft key menu where you can select the power meter range.

Discrete Values	Volts (V), Millivolts (mV), Decibel Volts (dBV)
Default	Volts (V)
Saved State	Saved with instrument state

DC Range (Voltmeter submenu)

When the meter is set to Voltmeter, pressing this soft key activates a horizontal soft key menu where you can select the power meter DC voltage range.

Discrete Values	Auto, 1 V, 10 V, 70 V
Default	Auto
Saved State	Saved with instrument state
Notes	The range on AC and DC must be 1 or 10 Volts to use 600 Ohm Input Impedance.

Decoder (METER Zone menu)

Opens the Decoder display and submenu.

Select Decoder Type (Decoder submenu)

When the meter is set to Decoder, pressing this soft key activates a horizontal soft key menu where you can select the decoder type.

Discrete Values	Voice Frame Decode
Default	Voice Frame Decode
Saved State	Saved with instrument state

Input Decoding (Decoder submenu)

When the meter is set to Decoder, pressing this soft key displays a Input Decoding dialog menu where you can select which decoding source to use.

Discrete Values	Internal, External
Default	Internal
Saved State	Saved with instrument state

RF Scan (METER Zone menu)

Opens the RF Scan display and submenu.

Start Frequency (RF Scan submenu)

When the meter is set to RF Scan, pressing this key displays the Start Frequency dialog where you can input the start frequency to be used in the RF scan.

Range	1 to 2991 MHz
Default	400 MHz
Saved State	Saved with instrument state

Stop Frequency (RF Scan submenu)

When the meter is set to RF Scan, pressing this key displays the Stop Frequency dialog where you can input the start frequency to be used in the RF scan.

Range	1 to 2991 MHz
Default	600 MHz
Saved State	Saved with instrument state

Scan (RF Scan submenu)

When the meter is set to RF Scan, pressing this soft key activates a horizontal soft key menu where you can select the scanning mode.

Discrete Values	Off, Single, Auto
Default	Off
Saved State	Saved with instrument state
Notes	<p>Off – Deactivates scanning.</p> <p>Single – Sweep the span defined by the Start and Stop Frequency parameters once.</p> <p>Auto – Continuously sweeps the span defined by the Start and Stop Frequency parameters .</p>

PROJECT 25 Zone Soft Keys for Receiver Test

These tests are performed with the R8200 in Generate of Duplex Mode. During Project 25 receiver tests, the PROJECT 25 Zone contains controls for the Project 25 receiver.

Gen Test Pattern (Project 25 submenu)

Activates a horizontal soft key menu where you can select one of seven TIA/EIA-102.CAAA compliant predefined bit patterns for BER testing of a P25 radio in Receive mode.

Discrete Values	1011 Hz Tone, Calibration (Tone 5%), Standard Tx (0.153/V.52), Silence, Symbol Rate, Low Deviation, C4FM Fidelity
Default	1011 Hz Tone
Saved State	Saved with instrument state
Notes	<p>To receive framed test patterns generated from the R8200, the radio under test must be programmed to the same Network Access Code (NAC). 293 is the default in the R8200; this will break the radio's selective squelch so the tone or pattern can be reproduced in the audio circuits. The following patterns are available:</p> <p>1011 Hz Tone - Standard tone framed test pattern of the 1011 Hz vocoder tone.</p> <p>Calibration (Tone 5%) - Derived from the standard 1011 Hz Tone test pattern used to verify BER measurements are operating correctly. Every 20th bit is inverted to yield 172 errors out of 3456 bits resulting in a 4.976852% BER.</p> <p>Standard Tx (0.153/V.52) - Standard transmitter test pattern of continuously repeating 511-bit pseudorandom number sequences based on ITU-T 0.153 (formerly CCITT V.52).</p> <p>Silence - Famed test pattern for silence at the vocoder.</p> <p>Symbol Rate - Maximum frequency deviation test pattern of a continuously repeating stream of high deviation symbols (+3, +3, -3, -3, ...).</p>

	<p>Low Deviation - Continuously repeating stream of low deviation symbols (+1, +1, -1, -1, ...) for a 1/3 maximum frequency deviation.</p> <p>C4FM Mod Fidelity - Continuously repeating 24 bit sequence (12 symbols) used for measuring C4FM modulation fidelity (+3, +3, -3, +1, +1, +3, -1, +3, -3, -1, -3, -3).</p> <p>Two additional TIA/EIA-102.CAAA compliant bit patterns can easily be created for testing a P25 radio in Receive Mode by using the procedure below:</p> <ol style="list-style-type: none"> 1. Set Test Pattern to 1011 Hz Tone. 2. Set Voice Frame Encoder, Status Symbols as specified below. <p>For compliance, the NAC and other voice frame fields should be defaults.</p> <p>Busy – Provides channel busy information.</p> <p>Idle – Provides channel idle information. Beware that one bit (2374) of this pattern will differ from TIA/EIA-102.CAAA (1.3.3.6 e) Standard Idle Test Pattern.</p> <p>These test patterns allow subscriber alignment for Automatic Frequency Control.</p>
--	--

Generate Modulation Type (Project 25 submenu)

Displays the Generate Modulation Type dialog where you can select the desired type of modulation for the generated signal required by the receiver.

Discrete Values	C4FM, LSM, WCQPSK
Default	C4FM
Saved State	Saved with instrument state

Modulation Mode (Project 25 submenu)

Activates a horizontal soft key menu where you can enable and disable Project 25 modulation.

Discrete Values	Off, Continuous, Burst
Default	Off
Saved State	Saved with instrument state
Notes	Enabling a test pattern in Generate Mode will erase any previously captured Voice Recordings.

NAC (Project 25 submenu)

Displays the NAC dialog where you can set the Network Access Code (NAC) to match the radio or system under test.

Range	0x000 to 0xFF
Default	0x293
Saved State	Saved with instrument state
Notes	In Generate Mode, the NAC soft key is hidden, and its display value is grayed out for unmodifiable test pattern selections (e.g., Calibration).

Voice Frame Encoder (Project 25 submenu)

Accesses a P25 Voice Frame Encoder to allow editing of embedded signaling information contained in the R8200 P25 voice frames, allowing the R8200 Voice Frame configuration to match the radio or system under test.

Notes	In Generate Mode, the Voice Frame Encoder soft key is hidden for unmodifiable test pattern selections (e.g., Calibration).
-------	--

NAC (Voice Frame Encoder submenu)

Displays a dialog where you can set the Network Access Code (NAC) to match the radio or system under test.

Range	0x000 to 0xFFFF
Default	0x293
Saved State	Saved with instrument state

Key ID (Voice Frame Encoder submenu)

When encryption is used, this key identifies the specific encryption key used when multiple keys are present on the encryption modules.

Range	0x0000 to 0xFFFF
Default	0x0000
Saved State	Saved with instrument state

Algorithm ID (Voice Frame Encoder submenu)

When encryption is used, this key identifies the specific encryption algorithm used in the system.

Range	0x00 to 0xFF
Default	0x80
Saved State	Saved with instrument state
Notes	Hexadecimal 80 is the default value, indicating no encryption algorithm is used. The range of values is from hexadecimal 00 to FF.

Status Symbols (Voice Frame Encoder submenu)

Activates a horizontal soft key menu where you can select the status of the inbound channel when the R8200 emulates a P25 repeater.

Discrete Values	0, 1, 2, 3
Default	0
Saved State	Saved with instrument state
Notes	0 – Unknown Talkaround 1 – Busy 2 – Unknown In/Out 3 – Idle

Low Speed Data (Voice Frame Encoder submenu)

Displays a dialog where you can enter custom user data not defined by the Common Air Interface (CAI).

Range	0x00000000 to 0xFFFFFFFF
Default	0x00000000
Saved State	Saved with instrument state

Talk Group ID (Voice Frame Encoder submenu)

Displays a dialog where you can select the Talk Group ID (TGID).

Range	0x0000 to 0xFFFF
Default	0x0001
Saved State	Saved with instrument state
Notes	The value entered is used for the header word as well as the Link Control word (if applicable).

MFID (Voice Frame Encoder submenu)

Displays a dialog where you can enter Manufacturer ID from assigned list.

Range	0x00 to 0xFF
Default	0x00
Saved State	Saved with instrument state
Notes	The value entered is used for the header word as well as the Link Control word (if applicable). The value entered is transmitted even if the Implicit MFID bit is set (SF=1); it is the receiver's responsibility to ignore it.

Raw (Hex) (Voice Frame Encoder submenu)

Displays the Raw (Hex) dialog where you can enter 18 hexadecimal digits into the Link Control Opcode field.

Range	Any 18-digit hexadecimal
Default	000000000001000001
Saved State	Saved with instrument state
Notes	RAW soft key is not displayed until Raw is chosen as the Link Control Opcode.

	0 - GRP_V_CH_USR (Group Voice Channel User) message, which indicates the user of this channel for group voice traffic, has the following fields: SF (MFID Format), Service Options, S (Explicit Source ID), Source Address (SID). Note: Manufacturer's ID and Group Address are specified in the Voice Frame Setup above, MFID and Talk Group ID respectively.
--	--

The Voice Frame fields are from the header word and interspersed status symbols. Although encryption is not supported, Header Word fields and the Link Control Format (LCF) will be displayed correctly because they are not subject to encryption. Therefore, if these fields indicate encryption, other fields will not be displayed correctly. Fields that are subject to encryption include the vocoder information and Link Control information content. See the table below.

Field	Mnemonic	Bits	Notes
Network Identifier	NID	16	
Network Access Code	NAC	12	293=Default
Data Unit ID	DUID	4	0=Header Data Unit
Header Word		120	
Message Indicator	MI	72	Encryption is not supported
Manufacturer's ID	MFID	8	Also copied to Link Control
Algorithm ID	ALGID	8	Encryption is not supported
Key ID	KID	16	Encryption is not supported
Talk-group ID	TGID	16	Also copied to Link Control
Link Control	LC	72	Format varies
Low Speed Data	LSD	32	
Status Symbols (6)	SS	12	2 bits after every 70 bits

Link Control Opcode (Voice Frame Encoder submenu)

Displays a dialog where you can select the Link Control Opcode.

Discrete Values	Raw, 0 – LC_GRP_V_CH_USR, 3 – LC_U2U_V_CH_USR
-----------------	---

Default	0 – LC_GRP_V_CH_USR
Saved State	Saved with instrument state
Notes	<p>The User Voice Call fields are from the Link Control code word.</p> <p>Raw – Displays all nine bytes directly; subsequent fields display the same information in individual fields according to the Link Control opcode (LCO), if applicable. Raw allows the information fields to be entered directly as 18 hex digits.</p> <p>0 – LC_GRP_V_CH_USR (Group Voice Channel User) – Indicates the user of this channel for group voice traffic on both inbound and outbound messages.</p> <p>3 – LC_U2U_V_CH_USR (Unit to Unit Voice Channel User) – Indicates the user of this channel for unit to unit voice traffic, on both inbound and outbound messages and on conventional and trunked systems.</p>

P25 Link Control Fields for LCO=1 are shown in the table below.

Field	Mnemonic	Bits	Notes
Format	LCF	8	
Protected flag	P	1	Encryption is not supported
Standard Format	SF	1	0=specification
Opcode	LCO	6	0=specification
Manufacturer's ID	MFID	8	Same as Header Word's MFID
Service Options		8	
Emergency	E	1	MSB
Protected	P	1	Encryption is not supported
Duplex	D	1	
Mode	M	1	
Reserved	R	1	
Priority Level		3	0 to 7 (lowest)
Reserved		8	
Group Address		16	Same as Header Word's TGID
Source Address		24	Also Source ID (SID)

P25 Link Control Fields for LCO=3 are shown in the table below.

Field	Mnemonic	Bits	Notes
Format	LCF	8	
Protected flag	P	1	Encryption is not supported
Standard Format	SF	1	0=specification
Opcode	LCO	6	3=specification
Manufacturer's ID	MFID	8	Same as Header Word
Service Options		8	
Emergency	E	1	Hex 80; MSB
Protected	P	1	Hex 40; Encryption is not supported
Duplex	D	1	Hex 20
Mode	M	1	Hex 10
Reserved	R	1	
Priority Level		3	00 to 07; highest to lowest
Target Address		24	Also Destination ID (DID)
Source Address		24	Also Source ID (SID)

SF – MFID Format (Voice Frame Encoder submenu)

Displays a dialog where you can select the SF – MFID Format.

Discrete Values	0 – Explicit Format, 1 – Standard MFID
Default	0 – Explicit Format
Saved State	Saved with instrument state
Notes	Not available when Link Control Opcode is set to Raw.

Service Options (Voice Frame Encoder submenu)

Displays a dialog where you can set the type of services in use by the subscriber unit.

Range	0x00 to 0xFF
Default	0x00
Saved State	Saved with instrument state
Notes	Not available when Link Control Opcode is set to Raw.

The Service Options entry is the hexadecimal sum of the values chosen from the table below.

Option	Status
E - Emergency	00 = Normal 80 = Emergency status requiring special processing
P – Protected (encrypted)	00 = Non-protected mode 40 = Protected mode
D – Duplex	00 = Half-duplex: the subscriber unit is capable of transmitting but not simultaneously receiving on the assigned channel. 20 = Full duplex: the subscriber unit is capable of transmitting and receiving simultaneously on the assigned channel.
M – Mode: data mode of service	00 = Circuit mode: the resources shall support circuit switch operation. 10 = Packet mode: the resources shall support packet switch operation.
R – Reserved	0 = Set by the sender and ignored by the receiver
P-L – Priority Level	0 – 7 = The relative importance attribute to the service that is being requested

S – Explicit Source ID (Voice Frame Encoder submenu)

Displays a dialog where you can select the Explicit Mode for the Source Address in the opcode.

Discrete Values	0 – Not Required, 1 – Required
Default	0 – Not Required

Saved State	Saved with instrument state
Notes	When set to “0- Not Required,” the Source ID address is sufficient to completely represent the requesting unit on the current P25 system. When set to “1 – Required,” the next Link Control message will have a Source ID extension carrying the complete SUID of the requesting unit.

Source Address (Voice Frame Encoder submenu)

Displays a dialog where you can enter the Source ID address of the requesting unit.

Range	0x000000 to 0xFFFFFFFF
Default	0x000001
Saved State	Saved with instrument state

Reset to Defaults (Voice Frame Encoder submenu)

Resets all Project 25 Voice Frame data fields to their default values.

Notes	All Voice Frame Encoder values are reset to default values without asking for confirmation.
-------	---

P25 Trunk Zone Soft Keys

This section contains detailed descriptions of the soft keys accessible in the Project 25 Trunk Zone during transmitter testing with the R8200 is in Monitor Mode, and receiver testing with the R8200 is in Generate Mode. Each Project 25 Trunk soft key is defined, along with its range, discrete, default, and saved state values.

"P25 Trunk Zone Soft Keys" above includes the parameters associated with testing the Project 25 Trunk radio's transmitter with the R8200 in Monitor Mode. For standard Monitor Mode soft key definitions, see **"8 Monitor Mode Soft Keys" on page 351**.

"DISPLAY Zone Soft Keys for P25 Trunk for Transmitter Test" on page 654 includes the parameters associated with specialized display configurations for quick visual verification of P25 Trunk transmitter performance. For standard DISPLAY Zone soft key definitions, see **"DISPLAY Zone Soft Keys for Monitor Mode" on page 383**.

"METER Zone Soft Keys for P25 Trunk Transmitter Test" on page 655 includes the parameters associated with specialized metering configurations offering focused presentations of basic RF and baseband P25 Trunk transmitter characteristics. For standard METER Zone soft key definitions, see **"METER Zone Soft Keys for Monitor Mode" on page 401**.

P25 Trunk Zone Soft Keys for Transmitter Test

P25 Trunk Mode simulates the functions of a Project 25 central controller with the control and voice channel protocols needed for various tests. These tests are performed with the R8200 in Duplex Mode. During P25 Trunk tests, the P25 Trunk Zone contains the controls for the P25 Trunk transceiver.

Generate Modulation Type (P25 Trunk submenu)

Opens a horizontal soft key menu where you can select the desired type of modulation for the generated signal required by the P25 Trunk transceiver.

Discrete Values	C4FM, LSM, WCQPSK
Default	C4FM
Saved State	Saved with instrument state

NAC (P25 Trunk submenu)

Opens the NAC (Hex) dialog where you can enter the hexadecimal value for the Network Access Code to match the radio or system under test.

Range	000 to FFF
Default	293
Saved State	Saved with instrument state
Notes	In Generate Mode, the NAC soft key is hidden, and its display value is grayed out for unmodifiable test pattern selections (e.g., Calibration).

Voice Call (P25 Trunk submenu)

Initiates a Voice Call test.

Discrete Values	Stop, Start
Default	Stop
Saved State	Saved with instrument state
Notes	The R8200 sends out a control channel message causing the subscriber radio to transition to a voice channel. The analyzer transmits a 1011 Hz tone that can be heard on the radio's speaker to confirm this transition.

Send Call Alert (P25 Trunk submenu)

Initiates a call alert to the subscriber radio under test to verify it is capable of registering and receiving a call alert from a P25 base station.

Saved State	Saved with instrument state
Notes	Messages in the METER Zone Status field show the activity during a Call Alert.

WACN ID (P25 Trunk submenu)

Sets the hexadecimal value for the Wide Area Communication Network Identity (WACN ID) of the P25 system being tested.

Range	00000 to FFFFF
Default	00001
Saved State	Saved with instrument state

SYSTEM ID (P25 Trunk submenu)

Sets the hexadecimal value for the System Identity within the WACN of the P25 system under test.

Range	000 to FFF
Default	001
Saved State	Saved with instrument state

Bandplan Table (P25 Trunk submenu)

Activates a submenu with a table that defines the channel characteristics for the P25 frequency band from the perspective of the radio.

Saved State	Saved with instrument state
Notes	All of the fields are used to create the Identifier Update (IDEN_UP/IDEN_UP_VU) TSBK for transmit to the radio; some are used by the R8200 to emulate the base station. The default plan can be customized with soft keys as described below. Custom bandplans may be saved, imported, or exported. If necessary, use RSS to read system values from the radio.

Select Plan (Bandplan Table submenu)

Opens a horizontal soft key menu where you can select the desired bandplan.

Discrete Values	800 MHz_Def, 700 MHz_Def, VHF_UHF_Def, user-defined
Default	800 MHz_Def
Saved State	Saved with instrument state

Save Plan As (Bandplan Table submenu)

Opens a horizontal soft key menu where you can enter the desired name to save a new band plan. Useful if user wants to begin with current band plan and adjust it, rather than start with one of the original templates.

Discrete Values	User-defined
Default	Empty
Saved State	Saved with instrument state

Base Frequency (Bandplan Table submenu)

Sets the radio's receive frequency for channel number 0.

Range	250 kHz to 1 GHz
Default	851.006250 MHz
Saved State	Saved with instrument state

Channel Spacing (Bandplan Table submenu)

Sets the frequency distance between adjacent channels in 0.125 kHz increments.

Range	0.125 kHz to 511.875 kHz
Default	6.250 kHz
Saved State	Saved with instrument state
Notes	This is used to compute the channel frequency from the channel number (or vice versa).

Transmit Offset (Bandplan Table submenu)

Sets the frequency offset from the radio receive frequency to the radio transmit frequency.

Range	–99.99999 MHz to 99.9999 MHz
Default	–45 MHz
Saved State	Saved with instrument state
Notes	Conversely, the setting defines the offset from the base station transmit frequency to the base station receive frequency. Radio TX frequency = Radio RX frequency + Transmit Offset Base Station TX frequency = Base Station RX frequency – Transmit Offset

Bandwidth (Bandplan Table submenu)

Opens a horizontal soft key menu where you can select the frequency for the current band.

Discrete Values	6.25 kHz, 12.5 kHz
Default	12.5 kHz
Saved State	Saved with instrument state

NAC (Bandplan Table submenu)

Opens the NAC (Hex) dialog where you can enter the hexadecimal value for the Network Access Code to match the radio or system under test.

Range	000 to FFF
Default	293
Saved State	Saved with instrument state
Notes	In Generate Mode, the NAC soft key is hidden, and its display value is grayed out for unmodifiable test pattern selections (e.g., Calibration).

WACN ID (Bandplan Table submenu)

Sets the hexadecimal value for the Wide Area Communication Network Identity (WACN ID) of the P25 system being tested.

Range	00000 to FFFFF
Default	00001
Saved State	Saved with instrument state

SYSTEM ID (Bandplan Table submenu)

Sets the hexadecimal value for the System Identity within the WACN of the P25 system under test.

Range	000 to FFF
Default	001
Saved State	Saved with instrument state

WUID (Bandplan Table submenu)

Sets the hexadecimal value for the Working Unit Identity (e.g., ID in the system).

Range	000000 to FFFFFFFF
Default	000001
Saved State	Saved with instrument state

RFSS ID (Bandplan Table submenu)

Sets the hexadecimal value for the RF Subsystem ID of the core infrastructure providing P25 service within the Wide Area Communication Network.

Range	00 to FF
Default	01
Saved State	Saved with instrument state

WGID (Bandplan Table submenu)

Sets the hexadecimal value for the identity of the site within the RF Subsystem..

Range	0000 to FFFF
Default	0001
Saved State	Saved with instrument state

SITE ID (Bandplan Table submenu)

Sets the hexadecimal value for the identity of the site within the RF Subsystem.

Range	00 to FF
Default	01
Saved State	Saved with instrument state

Identifier Update (Bandplan Table submenu)

Activates the Identifier Update that provides data to inform the subscriber unit of the parameters associated with a specific channel.

Discrete Values	On, Off
Default	Off
Saved State	Saved with instrument state
Notes	<p>On – The IDEN_UP TSBK appropriate for the specified Bandplan (see Bandplan Table submenu) is transmitted on the control channel. The 700 MHz and 800 MHz bands use the 800/700 MHz format IDEN_UP TSBK with fields set as specified in the Bandplan Table; the UHF/VHF bands use the UHF/VHF MHz format IDEN_UP_VU TSBK.</p> <p>Off – No IDEN_UP TSBK is transmitted on the control channel.</p>

Delete File (Bandplan submenu)

Deletes the selected bandplan from the analyzer hard disk.

Notes	<p>A prompt will ask for deletion confirmation.</p> <p>Only visible when a USB drive is connected and a custom bandplan file is available.</p>
-------	--

Delete All Files (Bandplan submenu)

Deletes all custom bandplan files from the analyzer hard disk.

Notes	A prompt will ask for deletion confirmation. Only visible when a USB drive is connected and a custom bandplan file is available.
-------	---

Export Bandplan (Bandplan submenu)

Exports either the selected bandplan or all bandplan files from the analyzer hard disk to attached USB media.

Notes	Only visible when a USB drive is connected and a custom bandplan file is available.
-------	---

Import Bandplan (Bandplan submenu)

Imports either the selected bandplan or all bandplan files from the analyzer hard disk to attached USB media.

Notes	Only visible when a USB drive is connected and a custom bandplan file is available.
-------	---

CCTx Channel ID (P25 Trunk submenu)

Selects the Channel ID configuration from current Plan selection to use for Control Channel transmitter.

Range	1 to 16
Default	1
Saved State	Saved with instrument state

Notes	<p>The CCTx field in the P25 Trunk zone displays the corresponding base station Control Channel Generate Frequency as determined by the Bandplan Table.</p> <p>The Control Chnl TX Frequency setting is updated accordingly or can be used to enter the frequency directly.</p> <p>Radio Generate Frequency = Base Frequency + Transmit Offset + (Channel Spacing * CCTx Channel #)</p>
-------	---

CCTx Channel (P25 Trunk submenu)

Sets the Control Channel number for the base station transmitter.

Range	0 to 4095
Default	0
Saved State	Saved with instrument state
Notes	<p>The CCTx field in the P25 Trunk zone displays the corresponding base station Control Channel Generate Frequency as determined by the Bandplan Table.</p> <p>The Control Chnl TX Frequency setting is updated accordingly or can be used to enter the frequency directly.</p> <p>Radio Generate Frequency = Base Frequency + Transmit Offset + (Channel Spacing * CCTx Channel #)</p>

Control Chnl TX Frequency (P25 Trunk submenu)

Sets the base station control channel transmitter frequency.

Range	250 kHz to 1 GHz
Default	851.00625 MHz
Saved State	Saved with instrument state
Notes	<p>The Control Chnl field displays the closest corresponding Control Channel number as determined by the Bandplan Table, which may result in a negative channel number if the specified frequency is less than the Bandplan Table's Base Frequency.</p> <p>The CCTx setting in the P25 Trunk zone is updated accordingly or can be used to enter the channel number instead.</p> <p>Control Chnl TX Frequency = Radio Control Channel TX Frequency – Transmit Offset</p>

CCRx Channel ID (P25 Trunk submenu)

Selects the Channel ID configuration from current Plan selection to use for Control Channel receiver.

Range	1 to 16
Default	1
Saved State	Saved with instrument state
Notes	<p>The CCRx field in the P25 Trunk zone displays the corresponding base station Control Channel Monitor Frequency as determined by the Bandplan Table.</p> <p>The Control Chnl RX Frequency setting is updated accordingly or can be used to enter the frequency directly.</p> <p>Radio Generate Frequency = Base Frequency + Transmit Offset + (Channel Spacing * CCRx Channel #)</p> <p>This softkey only visible when BS Mode is Explicit.</p>

CCRx Channel (P25 Trunk submenu)

Sets the Control Channel number for the base station receiver.

Range	0 to 4095
Default	0
Saved State	Saved with instrument state
Notes	This softkey only visible when BS Mode is Explicit.

Control Chnl RX Frequency (P25 Trunk submenu)

Sets the base station control channel receiver frequency.

Range	250 kHz to 1 GHz
Default	851.00625 MHz
Saved State	Saved with instrument state
Notes	This softkey only visible when BS Mode is Explicit.

VCTx Channel ID (P25 Trunk submenu)

Selects the Channel ID configuration from current Plan selection to use for Voice Channel transmitter.

Range	1 to 16
Default	1
Saved State	Saved with instrument state

VCTx Channel (P25 Trunk submenu)

Sets the Voice Channel number for the base station transmitter

Range	0 to 4095
Default	0
Saved State	Saved with instrument state

Voice Chnl TX Frequency (P25 Trunk submenu)

Sets the base station voice channel transmitter frequency.

Range	250 kHz to 1 GHz
Default	851.00625 MHz
Saved State	Saved with instrument state
Notes	<p>The Voice Chnl field displays the closest corresponding Voice Channel number as determined by the Bandplan Table, which may result in a negative channel number if the specified frequency is less than the Bandplan Table's Base Frequency.</p> <p>The VCTx setting is updated accordingly or can be used to enter the channel number instead.</p> <p>Voice Chnl TX Frequency = Radio Voice Channel TX Frequency – Transmit Offset.</p>

Reset Symbol Rate Error (P25 Trunk submenu)

Resets the displayed symbol rate error to 0.00 MHz.

BER Test (P25 Trunk submenu)

Sets the operating state of the bit error rate test.

Discrete Values	Stop, Start
Default	Stop
Saved State	Saved with instrument state
Notes	<p>Start – Displays a new P25 Trunk BER screen and submenu. When running, trunking operation ceases, and BER specific setting and display fields are available. Modulation Type, Modulation Mode, and Test Pattern settings are provided for testing receivers of base stations and radios that have been put into test mode with RSS.</p> <p>Stop – Ends the testing and restores the default screen/submenu.</p> <p>More in-depth BER testing of radios can be done in the R8200's Project 25 conventional Test Mode option. The Test Pattern setting, BER Test status, and calculated BER percentage are provided for testing base station and radio transmitters that have been put into Test Mode with RSS. Modulation Fidelity, Symbol Deviation, and Symbol Rate Error measurements are also available for the transmission signal being tested.</p> <p>BER test Monitor and Generate frequencies are specified via the RF Zone rather than the Bandplan Table.</p>

BS Mode (P25 Trunk submenu)

Toggles the base station operation mode between implicit and explicit.

Discrete Values	Implicit, Explicit
Default	Implicit
Saved State	Saved with instrument state

Notes	<p>Implicit – the radio in conjunction with the base station determine what channel/frequency pair the radio assigns to a particular network channel (a.k.a, Short Channel form).</p> <p>Explicit- the base station assigns the actual channel/frequency over the air by providing the exact TX and RX frequencies directly to the radio.</p>
-------	---

DISPLAY Zone Soft Keys for P25 Trunk for Transmitter Test

In P25 Trunk mode, the DISPLAY Zone shows the controls for the primary graticule measurement display or bar graphs. Use these soft keys to set your desired display.

Select Display (DISPLAY Zone menu)

Activates a horizontal soft key menu where you can select the display mode.

Discrete Values	Spec An, Oscilloscope, Eye Diagram, Distribution Plot
Default	Spec An
Saved State	Saved with instrument state

Spectrum Analyzer (DISPLAY Zone menu)

For Spectrum Analyzer soft key descriptions, see ["Spectrum Analyzer Soft Keys" on page 525](#).

Oscilloscope (DISPLAY Zone menu)

For Oscilloscope soft key descriptions, see ["Oscilloscope Soft Keys" on page 539](#).

Eye Diagram (DISPLAY Zone menu)

For Eye Diagram soft key descriptions, see ["Eye Diagram \(DISPLAY Zone menu\)" on page 602](#).

Distribution Plot (DISPLAY Zone menu)

For Distribution Plot soft key descriptions, see ["Distribution Plot \(DISPLAY Zone menu\)" on page 606](#).

METER Zone Soft Keys for P25 Trunk Transmitter Test

The METER Zone offers a specialized meter during P25 Trunk transmitter testing with the R8200 in Monitor Mode. The associated soft key is described below.

P25 Trunking Meter (METER Zone menu)

In P25 Trunk Test Mode, the METER Zone is preloaded with a P25 Trunking Meter.

NXDN™ Zone Soft Keys

This chapter contains detailed descriptions of the soft keys accessible in the NXDN™ Zone during transmitter testing with the R8200 in Monitor Mode, and receiver testing with the R8200 in Generate Mode. Each NXDN™ soft key is defined, along with its range, discrete, default, and saved state values.

"NXDN™ Zone Soft Keys for Transmitter Test" on the next page includes the parameters associated with testing the NXDN™ radio's transmitter with the R8200 in Monitor Mode. For standard Monitor Mode soft key definitions, see **"8 Monitor Mode Soft Keys" on page 351**.

"NXDN™ Zone Soft Keys" above includes the parameters associated with specialized display configurations for quick visual verification of NXDN™ transmitter performance. For standard DISPLAY Zone soft key definitions, see **"DISPLAY Zone Soft Keys for Monitor Mode" on page 383**.

"METER Zone Soft Keys for NXDN™ Transmitter Test" on page 661 includes the parameters associated with specialized metering configurations offering focused presentations of basic RF and baseband NXDN™ transmitter characteristics. For standard METER Zone soft key definitions, see **"METER Zone Soft Keys for Monitor Mode" on page 401**.

"NXDN™ Zone Soft Keys for Receiver Test" on page 666 includes the parameters associated with testing the NXDN™ radio's receiver with the R8200 in Generate Mode. For standard Generate Mode soft key definitions, see **"9 Generate Mode Soft Keys" on page 411**.

NXDN™ Zone Soft Keys for Transmitter Test

These tests are performed with the R8200 in Monitor Mode. During NXDN™ transmitter tests, the NXDN™ Zone contains controls for the NXDN™ receiver.

Bit Rate (NXDN™ submenu)

Selects the bit rate used by the NXDN™ radio.

Discrete Values	4800 bps, 9600 bps
Default	4800 bps
Saved State	Saved with instrument state
Notes	Use 4800 bps for 6.25 kHz channel and 9600 bps for 12.5 kHz channel.

Copy RAN to Generator (NXDN™ submenu)

Copies the Radio Access Number of the device under test to the generator.

Mon Test Pattern (NXDN™ submenu)

Provides selection of bit patterns for testing the radio in Transmit Mode while under Radio Service Software (RSS) control.

Discrete Values	1031 Hz Tone, 1011 Hz Tone, Calibration (0.153 2%), 511 (0.153/PN9)
Default	1031 Hz Tone
Saved State	Saved with instrument state

Notes	<p>1031 Hz Tone is the framed test pattern of the 1031 Hz half-rate vocoder tone (NXDN™ CAI compliant).</p> <p>1011 Hz Tone (Only selectable for Bit Rate 9600 bps) is the framed test pattern of the 1011 Hz full-rate vocoder tone (NXDN™ CAI compliant).</p> <p>Calibration (0.153 2%) is a test pattern derived from the 511 (0.153) pattern to yield a 2.005871% BER used to verify BER measurements are operating correctly.</p> <p>511 (0.153/PN9) is the unframed test pattern of continuously repeating 511-bit pseudo random number sequences generated with a nine-bit shift register (PN9) based on ITU-T 0.153 (formerly CCITT V.52) used to perform BER testing for checking the modulation, encoding, and timing of the transmit signal (NXDN™ CAI compliant).</p>
-------	---

BER Test (NXDN™ submenu)

Controls the operating state of Bit Error Rate (BER) testing.

Discrete Values	Stop, Start
Default	Stop
Saved State	Saved with instrument state
Notes	<p>This Bit Error Rate test checks the modulation, encoding, and timing of the transmit signal during the data transmission period. When performing the BER Test, the radio transmitter under test must be placed into a test diagnostic mode with the correct TX test pattern selected using the manufacturer's Radio Service Software (RSS). The test is done at nominal power with the radio transmitting the test pattern into the service monitor. (It is acceptable to have an attenuator between the radio under test and the service monitor.) BER test results, the percentage of bit differences between the bits of the selected Test Pattern and the bits from the received synchronized FDMA signal, are shown in the NXDN™ Zone in the BER field.</p>

Voice Loopback (NXDN™ submenu)

Enables the Voice Loopback NXDN™ feature (U.S. patent 5703479).

Discrete Values	Off, On
Default	Off
Saved State	Saved with instrument state
Notes	<p>Once enabled the R8200 automatically records voice channel data when the radio under test transmits a signal above the squelch level setting. A green Voice Playback Active indicator appears in the NXDN™ Zone when Voice Loopback is enabled on the Voice Loopback screen. The Record Duration setting determines the maximum length of the recording, and a bar graph meter shows the recording's progress. The recording continues if the transmission is longer than the duration, but only the most recent is retained. When the radio is un-keyed, the R8200 automatically switches to Generate Mode and transmits the captured voice channel information or speech back to the radio. This provides a quick end-to-end test of the NXDN™ radio transmitter and receiver. Voice channel recordings can be played back at any time by pressing the Play Last Recording soft key (this selection only appears after a recording has been made).</p> <p>Recorded information is lost if the is power cycled or if the Generate Mode is selected and a new test pattern is enabled by setting the Modulation Mode to Continuous or Burst.</p>

Play Last Recording (Voice Loopback submenu)

Places the R8200 in Generate Mode and modulates the carrier with the most recently recorded voice channel data after the Voice Loopback function is enabled.

Saved State	Saved with instrument state
Notes	<p>This selection appears only after a recording has been made. The total transmission time is equal to the length of recorded data, and a bar graph indicates the remaining transmission time during playback. Speech recorded from a transmitting NXDN™ radio under test should be heard from its receiver if the radio is operating properly.</p>

Record Duration (Voice Loopback submenu)

Opens the Record Duration dialog where you can set the maximum length of a recording.

Discrete Values	1, 2, 3, 4, 5, 6, 7, 8, 9, 10 seconds
Default	5 seconds
Saved State	Saved with instrument state
Notes	If the transmission is longer than the configured time, only the most recent portion of the recording is retained.

DISPLAY Zone Soft Keys for NXDN™ Transmitter Test

In NXDN™ mode, the DISPLAY Zone shows the controls for the primary graticule measurement display or bar graphs. Use these soft keys to set your desired display.

Select Display (DISPLAY Zone menu)

Opens a horizontal soft key menu where you can select the display type.

Discrete Values	Spec An, Mod Scope, Oscilloscope, Bar Graphs, Eye Diagram
Default	Spec An
Saved State	Saved with instrument state
Notes	Spec An is only available in Monitor Mode.

Eye Diagram (DISPLAY Zone menu)

Provides a visual display of the received NXDN™ signal and overlays the modulation response during two symbol periods over the four target crossing points for an ideal NXDN™ signal. Navigate to the DISPLAY Zone while in NXDN™ mode to select the Eye Diagram for viewing with the other NXDN™ measurements on the main screen. The Eye Diagram can indicate whether a transmitter has significant unbalances or offsets in the modulation circuitry by noting how tightly grouped the waveform is around the crossing points.

Display Mode (Eye Diagram submenu)

Selects the display presentation.

Discrete Values	Normal, Fade Away
Default	Normal
Saved State	Saved with instrument state
Notes	Normal indicates that the display updates continuously. Fade Away is similar to the Persistence Mode on an Oscilloscope. The intensity of each trace fades away or decays as new traces are received. The effect is to intensify the display in the area where the waveform spends most of its time. Whenever the Display Mode is changed, the R8200 reconfigures the presentation. This process takes approximately 10 seconds and is complete when the new setting appears in the Display Mode field.

METER Zone Soft Keys for NXDN™ Transmitter Test

The METER Zone offers specialized meters during NXDN™ transmitter testing with the R8200. Their associated soft keys are described below.

Select Meter (METER Zone menu)

Opens a horizontal soft key menu where you can choose from a Power Meter, Voltmeter, or RF Scan Meter.

Discrete Values	Power Meter, Voltmeter, RF Scan Meter
Default	Power Meter
Saved State	Saved with instrument state

Power Meter (METER Zone menu)

Opens the Power Meter display and submenu.

Range (Power Meter submenu)

When the meter is set to Power Meter, pressing this soft key activates a horizontal soft key menu where you can select the power meter range.

Discrete Values	5, 10, 50, 150 W
Default	50 W
Saved State	Saved with instrument state
Notes	For best accuracy, disable the Pre-amplifier in Monitor Mode and set the Gen Port in Generate Mode to RF In/Out.

Voltmeter (METER Zone menu)

Opens the Voltmeter display and submenu.

Select Voltmeter Mode (Voltmeter submenu)

When the meter is set to Voltmeter, pressing this soft key activates a horizontal soft key menu where you can select the voltage mode for the Voltmeter.

Discrete Values	AC Volts, DC Volts
Default	AC Volts
Saved State	Saved with instrument state
Notes	AC Volts measures AC voltage applied to the Meter In port. The dBm computation assumes an impedance of 600Ω.

Coupling (Voltmeter submenu)

When the meter is set to Voltmeter, pressing this soft key activates a Coupling dialog menu where you can select the input voltage coupling.

Discrete Values	DC, AC
Default	DC
Saved State	Saved with instrument state

AC Range (Voltmeter submenu)

When the meter is set to Voltmeter, pressing this soft key activates a horizontal soft key menu where you can select the power meter AC voltage range.

Discrete Values	Auto, 1 V, 10 V, 70 V
Default	Auto
Saved State	Saved with instrument state
Notes	The range on AC and DC must be 1 or 10 Volts to use 600 Ohm Input Impedance.

Set dBr Reference (Voltmeter submenu)

When the meter is set to Voltmeter and Voltmeter mode is set to AC, pressing this soft key sets a reference input voltage.

Notes	When selected, dBm measurements are frozen, and a dBr indicator appears. The dBr indicates the normalized measurement between the reference input voltage and the current input voltage.
-------	--

Clear dBr Reference (Voltmeter submenu)

When the meter is set to Voltmeter and Voltmeter mode is set to AC, pressing this soft key clears the dBr reference input voltage.

Voltage Units (Voltmeter submenu)

When the meter is set to Voltmeter, pressing this soft key activates a horizontal soft key menu where you can select the power meter range.

Discrete Values	Volts (V), Millivolts (mV), Decibel Volts (dBV)
Default	Volts (V)
Saved State	Saved with instrument state

DC Range (Voltmeter submenu)

When the meter is set to Voltmeter, pressing this soft key activates a horizontal soft key menu where you can select the power meter DC voltage range.

Discrete Values	Auto, 1 V, 10 V, 70 V
Default	Auto
Saved State	Saved with instrument state
Notes	The range on AC and DC must be 1 or 10 Volts to use 600 Ohm Input Impedance.

RF Scan (METER Zone menu)

Opens the RF Scan display and submenu.

Start Frequency (RF Scan submenu)

When the meter is set to RF Scan, pressing this key displays the Start Frequency dialog where you can input the start frequency to be used in the RF scan.

Range	1 to 2991 MHz
Default	400 MHz
Saved State	Saved with instrument state

Stop Frequency (RF Scan submenu)

When the meter is set to RF Scan, pressing this key displays the Stop Frequency dialog where you can input the start frequency to be used in the RF scan.

Range	1 to 2991 MHz
Default	600 MHz
Saved State	Saved with instrument state

Scan (RF Scan submenu)

When the meter is set to RF Scan, pressing this soft key activates a horizontal soft key menu where you can select the scanning mode.

Discrete Values	Off, Single, Auto
Default	Off
Saved State	Saved with instrument state
Notes	<p>Off – Deactivates scanning.</p> <p>Single – Sweep the span defined by the Start and Stop Frequency parameters once.</p> <p>Auto – Continuously sweeps the span defined by the Start and Stop Frequency parameters.</p> <p>The signal captured by the scan will automatically set the Monitor Frequency to the closest channel in the selected RF Bandwidth. For example, if the signal captured by the receiver in a 12.5 kHz BW is 390.011911 kHz, then the Monitor Frequency will be set to 390.0125 (i.e., the ideal channel frequency). This ensures that the Frequency Error meter will display the offset from this ideal.</p>

NXDN™ Zone Soft Keys for Receiver Test

These tests are performed with the R8200 in Generate Mode. During NXDN™ receiver tests, the NXDN™ Zone contains controls for the NXDN™ transmitter.

Bit Rate (NXDN™ submenu)

Selects the bit rate used by the NXDN™ radio.

Discrete Values	4800 bps, 9600 bps
Default	4800 bps
Saved State	Saved with instrument state
Notes	Use 4800 bps for 6.25 kHz channel and 9600 bps for 12.5 kHz channel.

RAN (NXDN™ submenu)

Opens the RAN dialog where you can input a 6-bit Radio Access Number for the device under test.

Range	0 to 63
Default	1
Saved State	Saved with instrument state
Notes	Radio Access Number is a six-bit field in the NXDN™ protocol RTCH/RDCH frame. In a conventional system, it is digital ID information equivalent to CTCSS/PL and CDCSS/DPL of analog FM radio systems. Selecting a RAN value to use is equivalent to selecting a CTCSS/PL tone or DCS/DPL code in an analog system. The basic premise is that stations sharing the same frequency but using different numbers do not have to listen to each other. In the digital squelch scheme, a number is sent by a transmitter to control the squelch opening of a receiver. Then number is encoded and sent by the transmitter, then decoded and used by the receiver. When the scheme is used, the receiver must receive the programmed number or it will mute the audio output (i.e., the operator will not hear anything from the radio unless the transmission contained the programmed number). Selectable numbers are 0-63. Numbers 1-63 may be used to identify/access groups of radios. Zero is equivalent to digital CSQ; if the receiver uses zero, then all stations on the frequency are heard regardless of the transmitted number.

Gen Test Pattern (NXDN™ submenu)

Opens a horizontal soft key menu offering a selection of Generator bit patterns for testing the NXDN™ radio receiver.

Discrete Values	1031 Hz Tone, 1011 Hz Tone, Calibration (0.153 2%), 511 (0.153), 511 (0.153) Framed, Interference (Interfering Modulation Data Stream), Max Freq Deviation, 1/3 Freq Deviation
Default	1031 Hz Tone
Saved State	Saved with instrument state
Notes	<p>1031 Hz Tone – Framed test pattern of the 1031 Hz half-rate vocoder tone (NXDN™ CAI compliant).</p> <p>1011 Hz Tone (Only selectable for Bit Rate 9600 bps) – Framed test pattern of the 1011 Hz full-rate vocoder tone (NXDN™ CAI compliant).</p> <p>Calibration (0.153 2%) – Derived from the 511 (0.153) pattern to yield a 2.005871% BER used to verify BER measurements are operating correctly.</p> <p>511 (0.153) - Unframed test pattern of continuously repeating 511-bit pseudo random number sequences generated with a nine-bit shift register (PN9) based on ITU-T 0.153 (formerly CCITT V.52) used to perform BER testing for checking the modulation, encoding, and timing of the transmit signal (NXDN™ CAI compliant).</p> <p>511 (0.153) Framed – Framed test pattern consisting of 73 384-bit frames that contain the 20-bit frame synchronization word and 364 bits of 52 copies of the 511-bit sequences (FSW + PN9) used to perform BER testing for checking the modulation, encoding, and timing of the transmit signal.</p> <p>Framed Interference (Interfering Modulation Data Stream) – 32767-bit pseudo-random number pattern defined by ITU-T.</p> <p>Max Freq Deviation – Maximum frequency deviation test pattern of a continuously repeating stream of high deviation symbols (+3, +3, -3, -3, ...).</p> <p>1/3 Freq Deviation – Continuously repeating stream of low deviation symbols (+1, +1, -1, -1, ...) for a 1/3 maximum frequency deviation.</p>

Modulation Mode (NXDN™ submenu)

Opens a horizontal soft key menu offering operating mode choices for Test Pattern modulation.

Discrete Values	Off, Continuous, Burst
Default	Off
Saved State	Saved with instrument state
Notes	Enabling a test pattern in Generate Mode will erase any previously captured Voice Recordings.

NXDN™ Trunk Zone Soft Keys

This chapter contains detailed descriptions of the soft keys accessible in the NXDN™ Trunk Zone during transmitter testing with the R8200 in Monitor Mode, and receiver testing with the R8200 in Generate Mode. Each NXDN™ Trunk soft key is defined, along with its range, discrete, default, and saved state values.

"NXDN™ Trunk Zone Soft Keys for Transmitter Test" on the next page includes the parameters associated with testing the NXDN™ Trunk radio's transmitter with the R8200 in Monitor Mode. For standard Monitor Mode soft key definitions, see **"8 Monitor Mode Soft Keys" on page 351**.

"DISPLAY Zone Soft Keys for NXDN™ Trunk" on page 678 includes the parameters associated with specialized display configurations for quick visual verification of DMR transmitter performance. For standard DISPLAY Zone soft key definitions, see **"DISPLAY Zone Soft Keys for Monitor Mode" on page 383**.

"METER Zone Soft Keys for NXDN™ Trunk Transmitter Test" on page 679 includes the parameters associated with specialized metering configurations offering focused presentations of basic RF and baseband NXDN™ Trunk transmitter characteristics. For standard METER Zone soft key definitions, see **"METER Zone Soft Keys for Monitor Mode" on page 401**.

NXDN™ Trunk Zone Soft Keys for Transmitter Test

During NXDN™ Trunk transmitter tests, the NXDN™ Trunk Zone contains controls for the NXDN™ Trunk receiver. During NXDN™ Trunk receiver tests, the NXDN™ Trunk Zone contains controls for the NXDN™ Trunk transmitter. These tests are performed with the R8200 in Duplex Mode.

Voice Call (NXDN™ Trunk submenu)

Controls the operating state of the Voice Call test.

Discrete Values	Stop, Start
Default	Stop
Saved State	Saved with instrument state
Notes	The R8200 sends out a control channel message causing the subscriber radio to transition to a voice channel. The analyzer transmits a 1031 Hz tone that should be heard on the radio to confirm this transition.

BER Test (NXDN™ Trunk submenu)

Controls the operating state of Bit Error Rate (BER) testing.

Discrete Values	Stop, Start
Default	Stop
Saved State	Saved with instrument state
Notes	Pressing Start displays a new NXDN™ Type C Trunk BER submenu. The default NXDN™ Type C Trunk Zone is changed to display BER specific data fields, including the Modulation Mode, selec-

	<p>ted Test Pattern, BER Test status, and calculated BER percentage. The test patterns are provided for testing base stations and radios in test mode with RSS.</p> <p>More in-depth BER testing of radios can be done in the optional NXDN™ Test Mode. BER test Monitor and Generate Frequencies are specified via the RF Zone rather than the trunking-specific channel numbers.</p>
--	--

Modulation Mode (BER Test submenu)

Controls the operating state of the BER modulation.

Discrete Values	Off, Continuous
Default	Off
Saved State	Saved with instrument state

Test Pattern (BER Test submenu)

Provides selection of an NXDN™ compliant predefined test pattern for BER testing of an NXDN™ radio in Transmit or Receive Mode.

Discrete Values	1031 Hz Tone, 1011 Hz Tone, Calibration (0.153 2%), 511 (0.153/PN9)
Default	1031 Hz Tone
Saved State	Saved with instrument state
Notes	Use BER Test to enable transmitter testing and Modulation Mode to control receiver testing. The following patterns are available:

	<p>1031 Hz Tone is the framed test pattern of the 1031 Hz half-rate vocoder tone (NXDN™ CAI compliant).</p> <p>1011 Hz Tone (Only selectable for Bit Rate 9600 bps) is the framed test pattern of the 1011 Hz full-rate vocoder tone (NXDN™ CAI compliant).</p> <p>Calibration (0.153 2%) is the test pattern derived from the 511 (0.153) pattern to yield a 2.005871% BER used to verify BER measurements are operating correctly.</p> <p>511 (0.153/PN9) is the unframed test pattern of continuously repeating 511-bit pseudo random number sequences generated with a nine-bit shift register (PN9) based on ITU-T 0.153 (formerly CCITT V.52) used to perform BER testing for checking the modulation, encoding, and timing of the transmit signal (NXDN™ CAI compliant).</p>
--	---

BER Test (BER Test submenu)

Controls the operating state of the BER test.

Discrete Values	Stop, Start
Default	Stop
Saved State	Saved with instrument state
Notes	Pressing Stop ends the BER test and restores the default NXDN™ Type C Trunk submenu.

Send Status Inquiry (NXDN™ Trunk submenu)

Initiates a status inquiry to the subscriber radio under test to verify it is capable of registering and receiving a message from a NXDN™ base station.

Saved State	Saved with instrument state
Notes	Messages in METER Zone Status field show the activity during a Status Inquiry.

CCTx Channel (NXDN™ Trunk submenu)

Sets the Control Channel for the transmitter.

Range	0 to 1023
Default	1
Saved State	Saved with instrument state

VCTx Channel (NXDN™ Trunk submenu)

Sets the Voice Channel for the transmitter.

Range	0 to 1023
Default	1
Saved State	Saved with instrument state

Control Chnl TX Frequency (NXDN™ Trunk submenu)

Sets the base station control channel transmission frequency.

Range	250 kHz to 1 GHz
-------	------------------

Default	851.00625 MHz
Saved State	Saved with instrument state
Notes	Control Chnl TX Frequency = Radio Control Channel TX Frequency – Transmit Offset.

Voice Chnl TX Frequency (NXDN™ Trunk submenu)

Sets the base station voice channel transmission frequency.

Range	250 kHz to 1 GHz
Default	851.00625 MHz
Saved State	Saved with instrument state
Notes	Voice Chnl TX Frequency = Radio Voice Channel TX Frequency – Transmit Offset

Transmit Offset (NXDN™ Trunk submenu)

Sets the frequency offset from the radio receive frequency to the radio transmit frequency in MHz.

Range	–99.99999 MHz to 99.9999 MHz
Default	–45 MHz
Saved State	Saved with instrument state
Notes	<p>Defines the offset from the base station transmit frequency to the base station receive frequency.</p> <p>Radio TX frequency = Radio RX frequency + Transmit Offset</p> <p>Base Station TX frequency = Base Station RX frequency – Transmit Offset</p>

System Code (NXDN™ Trunk submenu)

Sets the System Code within the NXDN™ system being tested.

Range	000 to 999
Default	1
Saved State	Saved with instrument state

Site Code (NXDN™ Trunk submenu)

Sets the identity of the site within the RF Subsystem.

Range	0 to 9
Default	1
Saved State	Saved with instrument state

Unit ID (NXDN™ Trunk submenu)

Sets the temporary Unit IDentity assigned by the R8200 to the subscriber unit being tested.

Range	0 to 65535
Default	1
Saved State	Saved with instrument state

Group ID (NXDN™ Trunk submenu)

Sets the temporary Group IDentity assigned by the R8200 to the subscriber unit being tested.

Range	0 to 65535
Default	1
Saved State	Saved with instrument state

Bit Rate (bps) (NXDN™ Trunk submenu)

Selects the system communication bit rate.

Discrete Values	4800 bps, 9600 bps
Default	4800 bps
Saved State	Saved with instrument state
Notes	4800 bps is used for 6.25kHz systems, and 9600 bps is used for 12.5kHz systems.

Voice Playback (NXDN™ Trunk submenu)

Sets the operating state of the Voice Playback feature.

Discrete Values	Off, On
Default	Off
Saved State	Saved with instrument state
Notes	When the voice playback feature is turned On, voice traffic from the radio is recorded. At the end of the radio's transmission, the R8200 will initiate a voice call to the radio and replay the recorded audio. The feature may be turned Off if audio playback is not desired.

DISPLAY Zone Soft Keys for NXDN™ Trunk

In NXDN™ Trunk mode, the DISPLAY Zone shows the controls for the primary graticule measurement display or bar graphs. Use these soft keys to set your desired display.

Select Display (DISPLAY Zone menu)

Opens a horizontal soft key menu where you can select the display type.

Discrete Values	Spec An, Mod Scope, Oscilloscope, Bar Graphs, Eye Diagram
Default	Spec An
Saved State	Saved with instrument state
Notes	Spec An is only available in Monitor Mode.

Eye Diagram (DISPLAY Zone menu)

Provides a visual display of the received NXDN™ trunk signal and overlays the modulation response during two symbol periods over the four target crossing points for an ideal NXDN™ Trunk signal. Navigate to the DISPLAY Zone while in NXDN™ Trunk mode to select the Eye Diagram for viewing with the other NXDN™ measurements on the main screen. The Eye Diagram can indicate whether a transmitter has significant unbalances or offsets in the modulation circuitry by noting how tightly grouped the waveform is around the crossing points.

Display Mode (DISPLAY Zone menu)

Selects the display presentation.

Discrete Values	Normal, Fade Away
-----------------	-------------------

Default	Normal
Saved State	Saved with instrument state
Notes	<p>Normal indicates that the display updates continuously.</p> <p>Fade Away is similar to the Persistence Mode on an Oscilloscope. The intensity of each trace fades away or decays as new traces are received. The effect is to intensify the display in the area where the waveform spends most of its time. Whenever the Display Mode is changed, the R8200 reconfigures the presentation. This process takes approximately 10 seconds and is complete when the new setting appears in the Display Mode field.</p>

METER Zone Soft Keys for NXDN™ Trunk Transmitter Test

The METER Zone offers specialized meters during NXDN™ Trunk transmitter testing with the R8200 in Monitor Mode. Their associated soft keys are described below.

NXDN™ Trunking (METER Zone menu)

In NXDN™ Trunk Test Mode, the METER Zone is preloaded with a NXDN™ Trunking Meter.

TETRA Base Station Test Mode Soft Keys

This section contains detailed descriptions of the soft keys accessible in the TETRA Base Station Test Mode. Each TETRA Base Station soft key is defined, along with its range, discrete, default, and saved state values.

"TETRA Base Station Test Mode Soft Keys" above includes the parameters associated with testing the TETRA base station radio's transmitter while **"TETRA Base Station T1 Mode Soft Keys" on page 690** includes the parameters associated with testing the TETRA Base Station radio's transceiver.

TETRA Base Station

Opens the TETRA Base Station Test Mode Main Screen in Monitor Mode.

Discrete Values	Channel Plan, Test Limits, T1 Test, Main Screen
Default	Main Screen
Saved State	Saved with instrument state

Graphical Displays (TETRA Base Station submenu)

Opens a vertical submenu where you can choose between a number of display types.

Bar Charts (Graphical Displays submenu)

Displays graphical representations of measured parameters.

Spectrum (Graphical Displays submenu)

Opens a Spectrum Analyzer display preconfigured for TETRA Base Station. For a complete list of Spectrum submenu soft keys, see **"Spectrum Analyzer Soft Keys" on page 525**.

Power Profile (Graphical Displays submenu)

Displays a TDMA slot view with 2 markers for timing analysis.

Vertical Maximum (Power Profile submenu)

Adjusts the maximum level for the vertical scale of the display.

Range	-120 dBm to +60 dBm in 1 dB increments
Default	50 dBm
Saved State	Saved with instrument state

Vertical Scale (Power Profile submenu)

Selects the vertical scale resolution for the display's major grid lines.

Range	1 dB/div to 10 dB/div
Default	10 dB/div
Saved State	Saved with instrument state

Display Mode (Power Profile submenu)

Defines the display trace sweep mode.

Discrete Values	Max Hold, Average
Default	Average
Saved State	Saved with instrument state
Notes	Max Hold retains the highest peak signal amplitudes measured during successive sweeps.

	Average displays signal amplitudes are a rolling average of the peak amplitudes measured on each successive sweep. The average consists of one to five sweeps, shown beside the mode indication.
--	--

Marker Mode (Power Profile submenu)

Defines the selected marker as Absolute or Delta.

Discrete Values	Absolute, Delta
Default	Absolute
Saved State	Saved with instrument state
Notes	Markers can be turned off or on with a choice of numeric readout for the signal measurements. Absolute provides actual peak readings while Delta measures the relative difference of both power and time between the markers.

Toggle Marker (Power Profile submenu)

Cycles through the available markers to select a marker for repositioning along the trace.

Constellation (Graphical Displays submenu)

Opens a Constellation Meter with Industry standard QPSK Constellations representing phase errors, amplitude errors, and I/Q Imbalance.

Upper Mini Graph (Graphical Displays submenu)

Displays a small Spectrum Analyzer, Power Profile, or Constellation Meter on the upper portion of the screen.

Discrete Values	Spectrum, Power Profile, Symbols, Trajectories
Default	Spectrum
Saved State	Saved with instrument state

Lower Mini Graph (Graphical Displays submenu)

Displays a small Spectrum Analyzer, Power Profile, or Constellation Meter on the lower portion of the screen.

Discrete Values	Spectrum, Power Profile, Symbols, Trajectories, Bar Graphs
Default	Power Profile
Saved State	Saved with instrument state

Downlink Frequency (TETRA Base Station submenu)

Sets the base station main carrier frequency.

Range	250 kHz to 1 GHz
Default	390 kHz
Saved State	Saved with instrument state

Attenuation (TETRA Base Station submenu)

Displays the Attenuation dialog where you can select the desired input port attenuation for the receiver.

Range	0 to 62 dB in 2 dB increments
Default	0 dB
Saved State	Saved with instrument state

Average Readings (TETRA Base Station submenu)

Sets the number of measurement samples that are averaged when Averaging is activated.

Range	1 to 100
Default	10
Saved State	Saved with instrument state

Cable Offset (TETRA Base Station submenu)

Displays a dialog where you can specify the gains or losses between the RF In/Out port and the unit under test.

Range	-99.0 to 99 dB
Default	0.0 dB
Saved State	Saved with instrument state
Notes	<p>In the case of a loss, such as a cable or attenuator, enter a negative value. The affected field values will be increased to compensate. In Generate Mode, for example, if a -6.0 dB value is entered, the Output Level amplitude is increased by 6 dB. In Monitor Mode, for example, the Spectrum Analyzer trace is increased by 6 dB.</p> <p>In the case of a gain, such as an amplifier, enter a positive value. The affected fields will be</p>

	<p>decreased to compensate. In Generate Mode, for example, if a 10.0 dB value is entered, the Output Level amplitude will decrease by 10 dB. In Monitor Mode, for example, Watt Meter measurements will be reduced by 10 dB.</p> <p>This value is not used if Cable Offset is disabled (Off).</p>
--	---

Gen Port (TETRA Base Station submenu)

In T1 mode, opens the Gen Port dialog where you can choose the transmitter output.

Discrete Values	RF In/Out, RF Gen Out
Default	RF In/Out
Saved State	Saved with instrument state

Monitor Port (TETRA Base Station submenu)

Opens the Monitor Port dialog where you can choose the receiver input.

Discrete Values	RF In/Out, Antenna
Default	RF In/Out
Saved State	Saved with instrument state

Pre-Amp (TETRA Base Station submenu)

Opens the Pre-Amp dialog where you can control pre-amp activation.

Discrete Values	Off, On
Default	Off
Saved State	Saved with instrument state

Test Limits (TETRA Base Station submenu)

Opens the Test Limits page where you can specify minimum and maximum measurement values for the test.

Limits Default (Test Limits & Bar Charts submenus)

Returns all Lower and Upper test limits to their default values.

RF Power Lower Limit (Test Limits & Bar Charts submenus)

Opens the RF Power Lower dialog where you can enter the desired value for the RF power lower limit.

Range	0 to 200 dB
Default	43 dB
Saved State	Saved with instrument state

RF Power Upper Limit (Test Limits & Bar Charts submenus)

Opens the RF Power Upper dialog where you can enter the desire value for the RF power upper limit.

Range	0 to 200 dB
Default	45 dB
Saved State	Saved with instrument state

Residual Carrier Power (Test Limits & Bar Charts submenus)

Opens the Residual Carrier dialog where you can set the percentage of maximum residual power.

Range	0 to 10 %
Default	5 %
Saved State	Saved with instrument state

Frequency Error (Test Limits & Bar Charts submenus)

Opens the Frequency Error dialog where you can set the percentage of maximum residual power.

Range	± 200 Hz
Default	± 100 Hz
Saved State	Saved with instrument state

RMS Vector (Test Limits & Bar Charts submenus)

Opens the RMS Vector dialog where you can set the percentage of maximum RMS vector error.

Range	0 to 50 %
Default	10 %
Saved State	Saved with instrument state

Peak Vector (Test Limits & Bar Charts submenus)

Opens the Peak Vector dialog where you can set the percentage of maximum peak vector error.

Range	0 to 50 %
Default	30 %
Saved State	Saved with instrument state

Uplink BER (Test Limits submenu)

Opens the Uplink BER dialog where you can set the maximum acceptable percentage of bit error rate for the Uplink Channel.

Range	0 to 10 %
Default	3 %
Saved State	Saved with instrument state

Uplink MER (Test Limits submenu)

Opens the Uplink MER dialog where you can set the maximum acceptable percentage of modulation error rate for the Uplink Channel.

Range	0 to 10 %
Default	3 %
Saved State	Saved with instrument state

Downlink BER (Test Limits submenu)

Opens the Downlink BER dialog where you can set the maximum acceptable percentage of bit error rate for the Downlink Channel.

Range	0 to 10 %
Default	3 %
Saved State	Saved with instrument state

Downlink MBR (Test Limits submenu)

Opens the Downlink MBR dialog where you can set the percentage of maximum bit rate for the Downlink Channel.

Range	0 to 10 %
Default	3 %
Saved State	Saved with instrument state

TX Test (TETRA Base Station submenu)

Opens the transmitter test setup page.

Burst Samples (TX Test submenu)

Defines the number of burst samples for the current transmitter test.

Range	1 to 1,000,000
Default	100
Saved State	Saved with instrument state

Start Test (TX Test submenu)

Executes the transmitter test.

Operator ID (Test Results submenu)

Displays a dialog where you can enter the Operator ID.

Range	A-Z and 0-9
Saved State	Saved with instrument state
Notes	By default, an Operator ID is required to begin testing (Start soft key appears after entry is made). This can be changed in the Preferences selection under the Tools menu.

Clear Results (Test Results submenu)

Clears the results of the selected test.

TETRA Base Station T1 Mode Soft Keys

During TETRA Base Station T1 Mode base station tests, the TETRA Base Station T1 Mode contains additional parameter controls for the TETRA Base Station Channel Plan and the T1 Test Table for offline transceiver performance verification using the manufacturer's Test Mode Software. These tests are performed with the R8200 in Duplex Mode.

T1 Test (TETRA Base Station submenu)

Opens the T1 Test table and submenu.

BS OEM (T1 Test submenu)

Defines the manufacturer of the base station under test.

Discrete Values	User Defined, Cassidian TB3, Motorola Dimetra, Motorola MTS 1
Default	User Defined
Saved State	Saved with instrument state

Uplink Signal Mode (T1 Test submenu)

Selects the communication mode from the portable to the base station.

Discrete Values	Auto, TX On, Transmit, Receive, Loopback, Manual Transmit, Manual Receive, Manual Loopback, Downlink T2 (No Scrambling)
Default	Auto
Saved State	Saved with instrument state

Uplink Signal Type (T1 Test submenu)

Selects the test channel type from the portable to the base station.

Discrete Values	Auto, TCH/7.2, SCH/F, STCH+STCH, SCH/HU+SCH/HU, TCH/S, TCH/2.4 N=1, TCH/4.8 N=1
Default	Auto
Saved State	Saved with instrument state

RF Output Level (TETRA Base Station submenu)

In T1 Test Mode, opens the RF Output dialog where you can input the output power of the RF In/Out port.

Range	-130 to -30 dBm
Default	-40 dBm
Saved State	Saved with instrument state

Test Results (T1 Test submenu)

Opens the Radio Test Results screen and displays the results of the T1 base station tests.

Channel Plan (TETRA Base Station submenu)

Opens the Channel System Table where you can configure the base station channel plan.

BS OEM (Channel Plan submenu)

Defines the manufacturer of the base station under test.

Discrete Values	User Defined, Cassidian TB3, Motorola Dimetra, Motorola MTS 1
Default	User Defined
Saved State	Saved with instrument state

Downlink Frequency (Channel Plan submenu)

Sets the base station main carrier frequency.

Range	250 kHz to 1 GHz
Default	390 kHz
Saved State	Saved with instrument state

Channel (Channel Plan submenu)

Opens the Channel dialog where you can choose the channel number for the channel plan.

Range	-10000 to 10000
Default	3600
Saved State	Saved with instrument state

Band (Channel Plan submenu)

Opens the Band dialog where you can choose the band frequency for the channel plan.

Discrete Values	100 MHz, 300 MHz, 400 MHz, 450 MHz, 800 MHz, 900 MHz
Default	300 MHz
Saved State	Saved with instrument state

Channel Offset (Channel Plan submenu)

Opens the Channel Offset dialog where you can choose the frequency offset for the channel plan.

Discrete Values	0 Hz, 6.250 kHz, -6.25 kHz, 12.500 kHz, -12.500 kHz
Default	0 Hz
Saved State	Saved with instrument state

Duplex Offset (Channel Plan submenu)

Opens the Duplex Offset dialog where you can choose the band-dependent duplex offset for the channel plan.

Discrete Values	1.6 MHz (Band=100 MHz), 4.5 MHz (Band=100 MHz), 5 MHz (Band=400 MHz or 450 MHz), 10 MHz (Band=300 MHz, 400 MHz, or 450 MHz), 45 MHz (Band=800 MHz or 900 MHz)
Default	1.6 MHz (Band=100 MHz)
Saved State	Saved with instrument state
Dependencies	Band dependent

Operating Mode (Channel Plan submenu)

Opens the Operating Mode dialog where you can choose normal or reverse operation for the channel plan.

Discrete Values	Normal, Reverse
Default	Normal
Saved State	Saved with instrument state

MCC (Channel Plan submenu)

Opens the MCC dialog where you can choose the mobile country code for the channel plan.

Range	0 to 500
Default	0
Saved State	Saved with instrument state

MNC (Channel Plan submenu)

Opens the MCC dialog where you can choose the mobile network code for the channel plan.

Range	0 to 10000
Default	0
Saved State	Saved with instrument state

BCC (Channel Plan submenu)

Opens the BCC dialog where you can choose the broadcast control channel for the channel plan.

Range	0 to 10
Default	0
Saved State	Saved with instrument state

TETRA DMO Zone Soft Keys

This section contains detailed descriptions of the soft keys accessible in the TETRA DMO Zone during transmitter testing with the R8200 in Monitor Mode, and receiver testing with the R8200 in Generate Mode. Each TETRA DMO soft key is defined, along with its range, discrete, default, and saved state values.

"TETRA DMO Zone Soft Keys for Transmitter Test" on the next page includes the parameters associated with testing the TETRA Base Station radio's transmitter with the R8200 in Monitor Mode.

"DISPLAY Zone Soft Keys for TETRA DMO Transmitter Test" on page 698 includes the parameters associated with specialized display configurations for quick visual verification of TETRA DMO transmitter performance. For standard DISPLAY Zone soft key definitions, see **"DISPLAY Zone Soft Keys for Monitor Mode" on page 383**.

"METER Zone Soft Keys for TETRA DMO Transmitter Test" on page 703 includes the parameters associated with specialized metering configurations offering focused presentations of basic RF and baseband TETRA DMO transmitter characteristics. For standard METER Zone soft key definitions, see **"METER Zone Soft Keys for Monitor Mode" on page 401**.

"TETRA DMO Zone Soft Keys for Receiver Test" on page 706 includes the parameters associated with testing the TETRA Base Station radio's receiver with the R8200 in Generate Mode.

TETRA DMO Zone Soft Keys for Transmitter Test

During TETRA DMO transmitter tests, the TETRA DMO Zone contains controls for the TETRA DMO receiver. These tests are performed with the R8200 in Monitor Mode. For standard Monitor Mode soft key definitions, see "**8 Monitor Mode Soft Keys**" on page 351.

Reset Averaging (TETRA DMO submenu)

Resets all TETRA DMO measurements, history, and displays including parameter values in other zones.

Measurement Averaging (TETRA DMO submenu)

Configures the number of traces sweeps averaged to smooth selective readings.

Range	1 to 250
Default	1 (no averaging)
Saved State	Saved with instrument state
Notes	Samples are collected five to 17 times per second. Measurement averaging affects the following: RF Zone – Input Level TETRA Zone – Residual Carrier Magnitude, EVM (RMS), EVM (Peak), Unwanted Power

Unwanted Power Slot 3 (TETRA DMO submenu)

Configures the unwanted power measurement to help isolate its cause as systemic or transient in nature.

Discrete Values	No, Yes
-----------------	---------

Default	No
Saved State	Saved with instrument state
Notes	<p>No – Computed measurement is the average power in slots 2 and 4 only, excluding active regions for adjacent slots.</p> <p>Yes – Compound measurement is the average power in slots 2, 3 and 4, excluding the active region(s) for slot 1.</p> <p>Unwanted power could be systemic or transient in nature. Use of this switch may be used to identify its nature. The average unwanted power of a systemic source will be the same for either setting, but transients in slot 2 or 4 will decrease for Yes (assuming slot 3 is not active).</p>

DISPLAY Zone Soft Keys for TETRA DMO Transmitter Test

The DISPLAY Zone offers specialized displays during TETRA DMO transmitter testing with the R8200 in Monitor Mode. Their associated soft keys are described below.

Select Display (DISPLAY Zone menu)

Pressing this soft key activates a horizontal soft key menu where you can select the display mode.

Discrete Values	Spec An, Power Profile, Mod Spec/Constellation
Default	Spec An
Saved State	Saved with instrument state
Notes	Spec An is only available in Monitor Mode.

Power Profile (DISPLAY Zone menu)

Provides a power versus time plot of the transmitter.

Saved State	Saved with instrument state
Notes	<p>The display is useful in assuring that near-far situations will not result in co-channel inter-slot interference on the alternate or non-transmission slot and that the power level will be adequate for acceptable BER performance.</p> <p>The scaling and position of the vertical power axis can be adjusted to inspect greater range or detail.</p> <p>The horizontal axis can be changed to view one or both slots including the additional ramp up/down time. Display functions and markers are available for advanced analysis.</p> <p>See the Technical Specification: ETSI TS 102 361-1 Electromagnetic compatibility and Radio Spectrum Matters (ERM); Digital Mobile Radio (DMR) Systems; Part 1: "DMR Air Interface (AI) protocol," section 10.2.3 Burst timing on page 114.</p>

Select View (Power Profile submenu)

Selects the timeslot(s) to view.

Discrete Values	Frame, Slot 1
Default	Frame
Saved State	Saved with instrument state
Notes	<p>Although slots are approximately 14.167 milliseconds (i.e., 1.02 seconds per multiframe of 18), the profile for a slot is 14.778 ms, divided into three regions for ramp-up (0.889 ms), burst (13.056 ms), and ramp-down (0.833 ms).</p> <p>Slot 1 reveals a horizontal axis 0 ms to 14.78 ms with slot from 0 to 14.167 ms.</p> <p>Frame reveals a horizontal axis 0 ms to 57.278 ms with four slots starting at 0 ms.</p> <p>Ramp down time for a slot overlaps the adjacent slot by 0.611 milliseconds.</p>

Vertical Maximum (Power Profile submenu)

Adjusts the maximum level for the vertical scale of the display.

Range	-120 dBm to +60 dBm in 1 dB increments
Default	50 dBm
Saved State	Saved with instrument state

Vertical Scale (Power Profile submenu)

Selects the vertical scale resolution for the display's major grid lines.

Range	1 dB/div to 10 dB/div
Default	10 dB/div
Saved State	Saved with instrument state

Mod Spec/Constellation (DISPLAY Zone menu)

Modulation Spectrum displays the power versus frequency (power spectral density) of the modulated symbols in the detected burst. Power is shown in dB relative to Input Level (0 dB); frequency is shown in kHz relative to Center Frequency (0 Hz). The measurement is done by over-sampling at the optimal symbol times and positions to exclude adverse effects of frequency error and residual carrier.

The Constellation Display provides a visual representation of overall transmitter operation. The constellation data represents just the data of the useful part of the burst. The measurement is done at the optimal symbol times and positions to exclude adverse effects of frequency error and residual carrier.

TETRA radios broadcast voice and data using four differential phase shift deviations from the carrier to represent symbols containing two data bits. One of four phase shifts relative to the carrier's current phase yields eight phase points. The phase trajectory never passes through the origin, ensuring that signal amplitude never falls to zero during

data transmissions. The center of the eight red circles on the display represent the expected locations for the deviation states when the radio is transmitting data bit symbols using the modulation. White dots show the actual deviation measurement at symbol decision times. A tighter grouping within the red circles indicates more accurate transmitter performance. The radius of the circles is the 10% EVM (Peak) limit.

Constellation Display Mode (Mod Spec/Constellation submenu)

Activates a horizontal soft key menu where can select the Constellation Display presentation.

Discrete Values	Symbols, Samples, Trajectories
Default	Trajectories
Saved State	Saved with instrument state
Notes	<p>Symbols – This choice displays only the samples at the optimal symbol decision times, displayed as white dots. Correct transmitter operation should group them tightly around the eight ideal phase points.</p> <p>Samples – In addition to the symbol points, samples between symbol times three times their number are displayed as blue dots.</p> <p>Trajectories – Instead of sample points, blue lines connect adjacent samples to approximate the continuous transmitter output throughout the burst.</p>

Display Mode (Power Profile submenu)

Defines the trace sweep.

Discrete Values	Normal, Freeze, Max Hold, Average
-----------------	-----------------------------------

Default	Normal
Saved State	Saved with instrument state
Notes	<p>Normal – allows the display to update continuously.</p> <p>Freeze – provides a snapshot of the current display indication and stops additional updates.</p> <p>Max Hold – retains the highest peak signal amplitudes measured during successive sweeps.</p> <p>Average – displays signal amplitudes are a rolling average of the peak amplitudes measured on each successive sweep. The average consists of one to five sweeps, shown beside the mode indication.</p>

Marker Mode (Power Profile submenu)

Defines the selected marker.

Discrete Values	Off, Absolute, Delta, Delta dBm
Default	Off
Saved State	Saved with instrument state
Notes	<p>Off – Deactivates markers.</p> <p>Absolute – Displays the frequency and absolute signal amplitude for each marker selected.</p> <p>Delta – Displays the frequency and amplitude difference between each pair of markers selected.</p> <p>Delta dBm – Displays the amplitude difference between each pair of markers selected.</p> <p>Depending on the installed options, up to four markers can be enabled and selected for positioning.</p>

Toggle Marker (Power Profile submenu)

Cycles through the available markers to select a marker for repositioning along the trace.

METER Zone Soft Keys for TETRA DMO Transmitter Test

The METER Zone offers specialized meters during TETRA DMO transmitter testing with the R8200 in Monitor Mode. Their associated soft keys are described below.

Voltmeter (METER Zone menu)

Opens the Voltmeter display and submenu.

Select Voltmeter Mode (Voltmeter submenu)

When the meter is set to Voltmeter, pressing this soft key activates a horizontal soft key menu where you can select the voltage mode for the Voltmeter.

Discrete Values	AC Volts, DC Volts
Default	AC Volts
Saved State	Saved with instrument state
Notes	AC Volts measures AC voltage applied to the Meter In port. The dBm computation assumes an impedance of 600Ω.

Coupling (Voltmeter submenu)

When the meter is set to Voltmeter, pressing this soft key activates a Coupling dialog menu where you can select the input voltage coupling.

Discrete Values	DC, AC
Default	DC
Saved State	Saved with instrument state

AC Range (Voltmeter submenu)

When the meter is set to Voltmeter, pressing this soft key activates a horizontal soft key menu where you can select the power meter AC voltage range.

Discrete Values	Auto, 1 V, 10 V, 70 V
Default	Auto
Saved State	Saved with instrument state
Notes	The range on AC and DC must be 1 or 10 Volts to use 600 Ohm Input Impedance.

Set dBr Reference (Voltmeter submenu)

When the meter is set to Voltmeter and Voltmeter mode is set to AC, pressing this soft key sets a reference input voltage.

Notes	When selected, dBm measurements are frozen, and a dBr indicator appears. The dBr indicates the normalized measurement between the reference input voltage and the current input voltage.
-------	--

Clear dBr Reference (Voltmeter submenu)

When the meter is set to Voltmeter and Voltmeter mode is set to AC, pressing this soft key clears the dBr reference input voltage.

Voltage Units (Voltmeter submenu)

When the meter is set to Voltmeter, pressing this soft key activates a horizontal soft key menu where you can select the power meter range.

Discrete Values	Volts (V), Millivolts (mV), Decibel Volts (dBV)
Default	Volts (V)
Saved State	Saved with instrument state

DC Range (Voltmeter submenu)

When the meter is set to Voltmeter, pressing this soft key activates a horizontal soft key menu where you can select the power meter DC voltage range.

Discrete Values	Auto, 1 V, 10 V, 70 V
Default	Auto
Saved State	Saved with instrument state
Notes	The range on AC and DC must be 1 or 10 Volts to use 600 Ohm Input Impedance.

TETRA DMO Zone Soft Keys for Receiver Test

During TETRA DMO receiver tests, the TETRA DMO Zone contains controls for the TETRA DMO transmitter. These tests are performed with the R8200 in Generate Mode. For standard Generate Mode soft key definitions, see "[9 Generate Mode Soft Keys](#)" on page 411.

Modulation Mode (TETRA DMO submenu)

Provides a horizontal soft key menu where you can control the operating state of the modulation.

Discrete Values	Off, Continuous
Default	Off
Saved State	Saved with instrument state

Test Pattern (TETRA DMO submenu)

Specifies the TETRA compliant test pattern generated by the R8200 to assess audio performance.

Discrete Values	1000 Hz Tone, Silence
Default	1000 Hz Tone
Saved State	Saved with instrument state
Notes	Audio patterns utilize digital vocoder type ACELP at a 7.2 kHz talk channel rate. For sensitivity tests, the R8200 can transmit the multiframe test pattern over its entire output power level range. This provides an estimate of the reference sensitivity for the radio. A horizontal submenu provides the following TETRA compliant patterns:

	<p>1000 Hz Tone provides a predefined TETRA-compatible vocoder multiframe test pattern that produces a 1 kHz tone at the speaker of the receiver vocoder. It can be used to quickly check audio performance in the field.</p> <p>Silence provides a predefined TETRA-compatible vocoder multiframe test pattern that results in silence at the vocoder.</p> <p>All patterns use the Open TSI (O-TSI) destination (Open MNI and Open SSI) as a convenience to eliminate the need to reprogram the radio's talkgroup/ID.</p>
--	--

TETRA TMO Test Mode Soft Keys

This section contains detailed descriptions of the soft keys accessible in the TETRA TMO Test Mode. Each TETRA TMO soft key is defined, along with its range, discrete, default, and saved state values. During TETRA TMO transmitter tests, the TETRA TMO Test Mode contains controls for the TETRA TMO receiver.

TETRA TMO (Main Screen)

Opens a horizontal soft key menu providing access to the TETRA TMO submenus.

Discrete Values	Call Mobile, Channel Plan, TX Test, RX Test, PLC Test, T1 Test, Main Screen
Default	Main Screen
Saved State	Saved with instrument state

Graphical Displays (Main Screen)

Opens a vertical submenu where you can choose between a number of display types.

Bar Charts (Graphical Displays submenu)

Displays graphical representations of measured parameters.

Limits Default (Bar Charts Test & Limits submenus)

Returns all Lower and Upper test limits to their default values.

RF Power Lower Limit (Bar Charts Test & Limits submenus)

Opens the RF Power Lower dialog where you can enter the desired value for the RF power lower limit.

Range	0 to 200 dB
Default	15 dB
Saved State	Saved with instrument state

RF Power Upper Limit (Bar Charts Test & Limits submenus)

Opens the RF Power Upper dialog where you can enter the desire value for the RF power upper limit.

Range	0 to 200 dB
Default	45 dB
Saved State	Saved with instrument state

Residual Carrier Power (Bar Charts Test & Limits submenus)

Opens the Residual Carrier dialog where you can set the percentage of maximum residual power.

Range	0 to 10 %
Default	5 %
Saved State	Saved with instrument state

Frequency Error (Bar Charts Test & Limits submenus)

Opens the Frequency Error dialog where you can set the percentage of maximum residual power.

Range	± 200 Hz
Default	± 100 Hz
Saved State	Saved with instrument state

RMS Vector (Bar Charts Test & Limits submenus)

Opens the RMS Vector dialog where you can set the percentage of maximum RMS vector error.

Range	0 to 50 %
Default	10 %
Saved State	Saved with instrument state

Peak Vector (Bar Charts Test & Limits submenus)

Opens the Peak Vector dialog where you can set the percentage of maximum peak vector error.

Range	0 to 50 %
Default	30 %
Saved State	Saved with instrument state

Spectrum (Graphical Displays submenu)

Opens a Spectrum Analyzer display preconfigured for TMO. For a complete list of Spectrum submenu soft keys, see ["Spectrum Analyzer Soft Keys" on page 525](#).

Power Profile (Graphical Displays submenu)

Displays a TDMA slot view with 2 markers for timing analysis.

Vertical Maximum (Power Profile submenu)

Adjusts the maximum level for the vertical scale of the display.

Range	-120 dBm to +60 dBm in 1 dB increments
Default	50 dBm
Saved State	Saved with instrument state

Vertical Scale (Power Profile submenu)

Selects the vertical scale resolution for the display's major grid lines.

Range	1 dB/div to 10 dB/div
Default	10 dB/div
Saved State	Saved with instrument state

Display Mode (Power Profile submenu)

Defines the display trace sweep mode.

Discrete Values	Max Hold, Average
Default	Average
Saved State	Saved with instrument state
Notes	Max Hold retains the highest peak signal amplitudes measured during successive sweeps.

	Average displays signal amplitudes are a rolling average of the peak amplitudes measured on each successive sweep. The average consists of one to five sweeps, shown beside the mode indication.
--	--

Marker Mode (Power Profile submenu)

Defines the selected marker as Absolute or Delta.

Discrete Values	Absolute, Delta
Default	Absolute
Saved State	Saved with instrument state
Notes	Markers can be turned off or on with a choice of numeric readout for the signal measurements. Absolute provides actual peak readings while Delta measures the relative difference of both power and time between the markers.

Toggle Marker (Power Profile submenu)

Cycles through the available markers to select a marker for repositioning along the trace.

Constellation (Graphical Displays submenu)

Opens a Constellation Display with Industry standard QPSK Constellations representing phase errors, amplitude errors, and I/Q Imbalance.

Upper Mini Graph (Graphical Displays submenu)

Displays a small Spectrum Analyzer, Power Profile, or Constellation Display on the upper portion of the main screen.

Discrete Values	Spectrum, Power Profile, Symbols, Trajectories
Default	Spectrum
Saved State	Saved with instrument state

Lower Mini Graph (Graphical Displays submenu)

Displays a small Spectrum Analyzer, Power Profile, Constellation, or Bar Graph on the lower portion of the main screen.

Discrete Values	Spectrum, Power Profile, Symbols, Trajectories, Bar Graphs
Default	Power Profile
Saved State	Saved with instrument state

Call Type (Main Screen)

Opens the Call Type dialog where you can choose the call type.

Discrete Values	Individual Duplex, Individual Simplex, Group, Phone, Emergency, SDS/DTMF/DGNA, Ambient Listening
Default	Individual Duplex
Saved State	Saved with instrument state
Notes	Individual Duplex is a Duplex bidirectional connection and can be used to make continuous measurements. Alternatively, Phone may be used.

Select Group (Main Screen)

Opens the Select Group dialog where you can choose the number associated with the group call.

Discrete Values	0
Default	0
Saved State	Saved with instrument state

Voice Loopback (Main Screen)

Opens the Voice Loopback dialog where you can select the content for Voice Loopback.

Discrete Values	Voice, 2.4kHz, 1.6kHz, 1kHz, 800Hz, 400Hz, Off
Default	Voice
Saved State	Saved with instrument state

RF Output Level (Main Screen)

In T1 test mode, opens the RF Output dialog where you can input the output power of the RF In/Out port.

Range	-130 to -30 dBm
Default	-40 dBm
Saved State	Saved with instrument state

Attenuation (Main Screen)

Displays the Attenuation dialog where you can select the desired input port attenuation for the receiver.

Discrete Values	0 to 62 dB in 2 dB steps
Default	0 dB
Saved State	Saved with instrument state

Average Readings (Main Screen)

Sets the number of measurement samples that are averaged when Averaging is activated.

Range	1 to 100
Default	10
Saved State	Saved with instrument state

Test Limits (Main Screen)

Opens the Test Limits page where you can specify minimum and maximum measurement values for the test.

Limits Default (Test Limits submenu)

Returns all Lower and Upper test limits to their default values.

Power Class (Test Limits submenu)

Opens the Power Class dialog where you can set the power class of the radio under test.

Discrete Values	2 (10 W), 2L (5.6 W), 3 (3 W), 3L (1.8 W), 4 (1 W), 4L (0.56 W)
Default	3L (1.8W)
Saved State	Saved with instrument state

Unwanted Power (Test Limits submenu)

Opens the Unwanted Power dialog where you can set the level for unwanted power for the radio under test.

Range	0 to -50 dBm
Default	-30 dBm
Saved State	Saved with instrument state

Residual Carrier Power (Test Limits submenu)

Opens the Residual Carrier dialog where you can set the percentage of maximum residual power.

Range	0 to 10 %
Default	5 %
Saved State	Saved with instrument state

Frequency Error (Test Limits submenu)

Opens the Frequency Error dialog where you can set the percentage of maximum residual power.

Range	± 200 Hz
Default	± 100 Hz
Saved State	Saved with instrument state

RMS Vector (Test Limits submenu)

Opens the RMS Vector dialog where you can set the percentage of maximum RMS vector error.

Range	0 to 50 %
Default	10 %
Saved State	Saved with instrument state

Peak Vector (Test Limits submenu)

Opens the Peak Vector dialog where you can set the percentage of maximum peak vector error.

Range	0 to 50 %
Default	30 %
Saved State	Saved with instrument state

Frame Align Symbols (Test Limits submenu)

Opens the Frame Align Symbols dialog where you can set the absolute value of symbol error.

Range	± 0.25 symbols
Default	0.25
Saved State	Saved with instrument state

RX Sensitivity (Test Limits submenu)

Opens the RX Sensitivity dialog where you can set the sensitivity for the receiver.

Range	0 to -125 dBm
Default	-114 dBm
Saved State	Saved with instrument state

MS T1 BER (Test Limits submenu)

Opens the MS T1 BER dialog where you can set the bit error rate percentage for the mobile station.

Range	0 to 10 %
Default	3 %
Saved State	Saved with instrument state

MS T1 MER (Test Limits submenu)

Opens the MS T1 MER dialog where you can set the modulation error rate percentage for the mobile station.

Range	0 to 10 %
Default	3 %
Saved State	Saved with instrument state

Sync (Main Screen)

Synchronizes the analyzer to the base station under test.

Command Registration (Main Screen)

Requests registration from the radio under test.

Call Mobile (Main Screen)

Initiates a call to the radio under test.

Release Call (Main Screen)

Terminates a call to the radio under test.

Channel Plan (Main Screen)

Opens the Channel Plan table and submenu.

Frequency (Channel Plan submenu)

Sets the channel plan carrier frequency.

Range	250 kHz to 1 GHz
Default	390 kHz
Saved State	Saved with instrument state

Band (Channel Plan submenu)

Opens the Band dialog where you can choose the frequency band for the channel plan.

Discrete Values	100 MHz, 300 MHz, 400 MHz, 450 MHz, 800 MHz, 900 MHz
Default	300 MHz
Saved State	Saved with instrument state

MCCH (Channel Plan submenu)

Opens the MCCH dialog where you can choose the channel number for the Main Control Channel for the channel plan.

Range	0 to 10000
Default	3600
Saved State	Saved with instrument state

TS (Channel Plan submenu)

Opens the TS dialog where you can choose the measurement timeslot for the channel plan.

Discrete Values	2, 3, 4
Default	2
Saved State	Saved with instrument state

Channel Offset (Channel Plan submenu)

Opens the Channel Offset dialog where you can choose the frequency offset for the channel plan.

Discrete Values	0 Hz, 6.250 kHz, -6.25 kHz, 12.500 kHz, -12.500 kHz
Default	0 Hz
Saved State	Saved with instrument state

Duplex Offset (Channel Plan submenu)

Opens the Duplex Offset dialog where you can choose the band-dependent Duplex Offset for the channel plan.

Discrete Values	1.6 MHz (Band=100 MHz), 4.5 MHz (Band=100 MHz), 5 MHz (Band=400 MHz or 450 MHz), 10 MHz (Band=300 MHz, 400 MHz, or 450 MHz), 45 MHz (Band=800 MHz or 900 MHz)
Default	10 MHz
Saved State	Saved with instrument state
Dependencies	Band dependent

Operating Mode (Channel Plan submenu)

Opens the Operating Mode dialog where you can choose Normal or Reverse Operation for the channel plan.

Discrete Values	Normal, Reverse
Default	Normal
Saved State	Saved with instrument state

Connection Mode (Channel Plan submenu)

Opens the Connection Mode dialog where you can choose Normal or Fallback Connection Mode for the channel plan.

Discrete Values	Normal, Fallback
Default	Normal
Saved State	Saved with instrument state

MCC (Channel Plan submenu)

Opens the MCC dialog where you can choose the Mobile Country Code for the channel plan.

Range	0 to 500
Default	262
Saved State	Saved with instrument state

MNC (Channel Plan submenu)

Opens the MCC dialog where you can choose the Mobile Network Code for the channel plan.

Range	0 to 10000
Default	1234
Saved State	Saved with instrument state

BCC (Channel Plan submenu)

Opens the BCC dialog where you can choose the Broadcast Control Channel for the channel plan.

Range	0 to 10
Default	5
Saved State	Saved with instrument state

Larea (Channel Plan submenu)

Opens the Larea dialog where you can choose the Local Area Code for the channel plan.

Range	0 to 100
Default	27
Saved State	Saved with instrument state

TX Test (Main Screen)

Opens the Transmitter Test Setup table and submenu.

Burst Samples (TX Test submenu)

Defines the number of burst samples for the current transmitter test.

Range	1 to 1,000,000
Default	100
Saved State	Saved with instrument state

Start Test (TX Test submenu)

Executes the transmitter test.

Test Results (TX Test submenu)

Opens the Radio Test Results screen and displays the results of the tests.

Operator ID (Test Results submenu)

Displays a dialog where you can enter the Operator ID.

Range	A-Z and 0-9
Saved State	Saved with instrument state
Notes	By default, an Operator ID is required to begin testing (Start soft key appears after entry is made). This can be changed in the Preferences selection under the Tools menu.

Mobile ID (Test Results submenu)

Displays a dialog where you can enter the Mobile ID.

Range	A-Z and 0-9
Saved State	Saved with instrument state

Clear Results (Test Results submenu)

Clears the current test results.

RX Test (Main Menu)

Opens the Receiver Sensitivity Test table and submenu.

Start Level (RX Test submenu)

Opens the Start Level dialog where you can enter the initial RF carrier level for the receiver sensitivity test.

Range	-130 to -30 dBm
Default	-100 dBm
Saved State	Saved with instrument state

Step Level (RX Test submenu)

Opens the Step Level dialog where you can enter the dB increments in which to decrease the RF carrier for the receiver sensitivity test.

Range	1 to 10 dB
Default	2 dB
Saved State	Saved with instrument state

Start RX Test (RX Test submenu)

Executes the receiver sensitivity test.

Test Results (RX Test submenu)

Opens the Radio Test Results screen and displays the results of the tests.

Operator ID (Test Results submenu)

Displays a dialog where you can enter the Operator ID.

Range	A-Z and 0-9
Saved State	Saved with instrument state
Notes	By default, an Operator ID is required to begin testing (Start soft key appears after entry is made). This can be changed in the Preferences selection under the Tools menu.

Mobile ID (Test Results submenu)

Displays a dialog where you can enter the Mobile ID.

Range	A-Z and 0-9
Saved State	Saved with instrument state
Notes	By default, an Operator ID is required to begin testing (Start soft key appears after entry is made). This can be changed in the Preferences selection under the Tools menu.

Clear Results (Test Results submenu)

Clears the current test results.

PLC Test (Main Menu)

Opens the Power Loop Control Test table and submenu.

Start PLC Test (PLC Test submenu)

Starts the PLC test.

Test Results (PLC Test submenu)

Opens the Radio Test Results screen and displays the results of the tests.

Operator ID (Test Results submenu)

Displays a dialog where you can enter the Operator ID.

Range	A-Z and 0-9
Saved State	Saved with instrument state
Notes	By default, an Operator ID is required to begin testing (Start soft key appears after entry is made). This can be changed in the Preferences selection under the Tools menu.

Mobile ID (Test Results submenu)

Displays a dialog where you can enter the Mobile ID.

Range	A-Z and 0-9
Saved State	Saved with instrument state

Clear Results (Test Results submenu)

Clears the current test results.

T1 Test (Main Menu)

Opens the T1 Test table and submenu.

T1 Burst Type (T1 Test submenu)

Displays the T1 Burst Type dialog where you can enter the base station burst type.

Discrete Values	TCH/7.2, SCH/F, BSCH+SCH/HD
Default	TCH/7.2
Saved State	Saved with instrument state

MS Mode (T1 Test submenu)

Opens the MS Mode dialog where you can set the mobile station test.

Discrete Values	MS TX Test, MS RX Test, RF Loopback
Default	MS TX Test
Saved State	Saved with instrument state

RF Output Level (T1 Test submenu)

In T1 test mode, opens the RF Output dialog where you can input the output power of the RF In/Out port.

Range	-130 to -30 dBm
Default	-90 dBm
Saved State	Saved with instrument state

Start Test (T1 Test submenu)

Initiates the T1 test.

Stop Test (T1 Test submenu)

Terminates the T1 test.

ETSI Test (T1 Test submenu)

Initiates the ETSI T1 test.

Test Results (T1 Test submenu)

Opens the Radio Test Results screen and displays the results of the tests.

Operator ID (Test Results submenu)

Displays a dialog where you can enter the Operator ID.

Range	A-Z and 0-9
Saved State	Saved with instrument state
Notes	By default, an Operator ID is required to begin testing (Start soft key appears after entry is made). This can be changed in the Preferences selection under the Tools menu.

Mobile ID (Test Results submenu)

Displays a dialog where you can enter the Mobile ID.

Range	A-Z and 0-9
Saved State	Saved with instrument state

Clear Results (Test Results submenu)

Clears the current test results.

dPMR Zone Soft Keys

This section contains detailed descriptions of the soft keys accessible in the dPMR Zone during transmitter testing with the R8200 in Monitor Mode, and receiver testing with the R8200 in Generate Mode. Each dPMR soft key is defined, along with its range, discrete, default, and saved state values.

"dPMR Zone Soft Keys" above includes the parameters associated with testing the dPMR radio's transmitter with the R8200 in Monitor Mode. For standard Monitor Mode soft key definitions, see **"8 Monitor Mode Soft Keys" on page 351**.

"DISPLAY Zone Soft Keys for dPMR Transmitter Test" on page 734 includes the parameters associated with specialized display configurations for quick visual verification of dPMR transmitter performance. For standard DISPLAY Zone soft key definitions, see **"DISPLAY Zone Soft Keys for Monitor Mode" on page 383**.

"METER Zone Soft Keys for dPMR Transmitter Test" on page 736 includes the parameters associated with specialized metering configurations offering focused presentations of basic RF and baseband dPMR transmitter characteristics. For standard METER Zone soft key definitions, see **"METER Zone Soft Keys for Monitor Mode" on page 401**.

"dPMR Zone Soft Keys for Receiver Test" on page 740 includes the parameters associated with testing the dPMR radio's receiver with the R8200 in Generate Mode. For standard Generate Mode soft key definitions, see **"9 Generate Mode Soft Keys" on page 411**.

dPMR Zone Soft Keys for Transmitter Test

During dPMR transmitter tests, the dPMR Zone contains controls for the dPMR receiver. These tests are performed with the R8200 in Monitor Mode.

Test Pattern (dPMR submenu)

Provides selection of bit patterns for testing the radio in Transmit Mode while under RSS control.

Discrete Values	Calibration (0.153 2%), 511 (0.153)
Default	Calibration (0.153 2%)
Saved State	Saved with instrument state
Notes	<p>The following test patterns are available:</p> <p>Calibration (0.153 2%) is a test pattern derived from the 511 (0.153) pattern to yield a 2.005871% BER used to verify BER measurements are operating correctly.</p> <p>511 (0.153) is the unframed test pattern of continuously repeating 511-bit pseudo random number sequences generated with a nine-bit shift register (PN9) based on ITU-T 0.153 (formerly CCITT V.52) used to perform BER testing for checking the modulation, encoding, and timing of the transmit signal (dPMR CAI compliant).</p>

BER Test (dPMR submenu)

Activates a horizontal soft key menu where you can control the operating state of bit error rate testing.

Discrete Values	Stop, Start
-----------------	-------------

Default	Stop
Saved State	Saved with instrument state
Notes	This bit error rate test checks the modulation, encoding, and timing of the transmit signal during the data transmission period. When performing the BER Test, the radio transmitter under test must be placed into a test diagnostic mode with the correct TX test pattern selected using the manufacturer's Radio Service Software (RSS). The test is done at nominal power with the radio transmitting the test pattern into the service monitor. (It is acceptable to have an attenuator between the radio under test and the service monitor.) BER test results, the percentage of bit differences between the bits of the selected Test Pattern and the bits from the received synchronized FDMA signal, are shown in the dPMR Zone in the BER field.

Ideal Sym Dev (dPMR submenu)

Opens the Ideal Sym Dev dialog where you can set the ideal symbol deviation for the modulation.

Range	800 Hz to 2400 Hz
Default	1050 Hz
Saved State	Saved with instrument state

Filter (dPMR submenu)

Activates a horizontal soft key menu where you can control the filter type.

Discrete Values	ETSI, PDR
Default	ETSI
Saved State	Saved with instrument state

Voice Loopback (dPMR submenu)

Enables the Voice Loopback feature in dPMR Mode (U.S. patent 5703479).

Discrete Values	Off, On
Default	Off
Saved State	Saved with instrument state
Notes	<p>Once enabled the R8200 automatically records voice channel data when the radio under test transmits a signal above the squelch level setting. A green Voice Playback Active indicator appears in the Test Mode Zone when Voice Loopback is enabled on the Voice Loopback screen. The Record Duration setting determines the maximum length of the recording, and a bar graph meter shows the recording's progress. The recording continues if the transmission is longer than the duration, but only the most recent is retained. When the radio is un-keyed, the R8200 automatically switches to Generate Mode and transmits the captured voice channel information or speech back to the radio. This provides a quick end-to-end test of the dPMR radio transmitter and receiver.</p> <p>Voice channel recordings can be played back at any time by pressing the Play Last Recording soft key (this selection only appears after a recording has been made).</p> <p>Recorded information is lost if the R8200 is power cycled or if the Generate Mode is selected and a new test pattern is enabled by setting the modulation mode to Continuous or Burst.</p>

Play Last Recording (Voice Loopback submenu)

Places the R8200 in Generate Mode and modulates the carrier with the most recently recorded voice channel data after the Voice Loopback function is enabled.

Saved State	Saved with instrument state
Notes	This selection appears only after a recording has been made. The total transmission time is equal to the length of recorded data, and a bar graph indicates the remaining transmission time during playback. Speech recorded from a transmitting dPMR radio under test should be heard from its receiver if the radio is operating properly.

Record Duration (Voice Loopback submenu)

Sets the maximum length of a recording.

Range	1 to 10 seconds
Default	5 seconds
Saved State	Saved with instrument state
Notes	If the recording is longer than 10 seconds, only the most recent portion is retained.

DISPLAY Zone Soft Keys for dPMR Transmitter Test

The DISPLAY Zone offers specialized displays during dPMR transmitter testing with the R8200 in Monitor Mode. Their associated soft keys are described below.

Select Display (DISPLAY Zone menu)

Pressing this soft key activates a horizontal soft key menu where you can select the display mode.

Discrete Values	Spec An, Mode Scope, Oscilloscope, Bar Graphs, Eye Diagram
Default	Spec An
Saved State	Saved with instrument state

Eye Diagram (DISPLAY Zone menu)

Provides a visual display of the received dPMR signal and overlays the modulation response during two symbol periods over the four target crossing points for an ideal dPMR signal.

Saved State	Saved with instrument state
Notes	Navigate to the DISPLAY Zone while in dPMR Mode to select the Eye Diagram for viewing with the other dPMR measurements on the main screen. The Eye Diagram can indicate whether a transmitter has significant unbalances or offsets in the modulation circuitry by noting how tightly grouped the waveform is around the crossing points.

Display Mode (Eye Diagram submenu)

When the display is set to Eye Diagram, pressing this soft key activates a horizontal soft key menu where you can select the Eye Diagram display mode.

Discrete Values	Normal, Fade Away
Default	Normal
Saved State	Saved with instrument state
Notes	<p>The following horizontal menu choices:</p> <p>Normal allows the display to update continuously.</p> <p>Fade Away is similar to the Persistence Mode on an Oscilloscope. The intensity of each trace fades away or decays as new traces are received. The effect is to intensify the display in the area where the waveform spends most of its time.</p> <p>Whenever the Display Mode is changed, the R8200 reconfigures the presentation. This process takes approximately 10 seconds and is complete when the new setting appears in the Display Mode field.</p>

METER Zone Soft Keys for dPMR Transmitter Test

The METER Zone offers specialized meters during dPMR transmitter testing with the R8200 in Monitor Mode. Their associated soft keys are described below.

Power Meter (METER Zone menu)

Opens the Power Meter display and submenu.

Range (Power Meter submenu)

When the meter is set to Power Meter, pressing this soft key activates a horizontal soft key menu where you can select the power meter range.

Discrete Values	5, 10, 50, 150 W
Default	50 W
Saved State	Saved with instrument state
Notes	For best accuracy, disable the Pre-amplifier in Monitor Mode and set the Gen Port in Generate Mode to RF In/Out.

Voltmeter (METER Zone menu)

Opens the Voltmeter display and submenu.

Select Voltmeter Mode (Voltmeter submenu)

When the meter is set to Voltmeter, pressing this soft key activates a horizontal soft key menu where you can select the voltage mode for the Voltmeter.

Discrete Values	AC Volts, DC Volts
Default	AC Volts
Saved State	Saved with instrument state
Notes	AC Volts measures AC voltage applied to the Meter In port. The dBm computation assumes an impedance of 600Ω.

Coupling (Voltmeter submenu)

When the meter is set to Voltmeter, pressing this soft key activates a Coupling dialog menu where you can select the input voltage coupling.

Discrete Values	DC, AC
Default	DC
Saved State	Saved with instrument state

AC Range (Voltmeter submenu)

When the meter is set to Voltmeter, pressing this soft key activates a horizontal soft key menu where you can select the power meter AC voltage range.

Discrete Values	Auto, 1 V, 10 V, 70 V
Default	Auto
Saved State	Saved with instrument state
Notes	The range on AC and DC must be 1 or 10 Volts to use 600 Ohm Input Impedance.

Set dBr Reference (Voltmeter submenu)

When the meter is set to Voltmeter and Voltmeter mode is set to AC, pressing this soft key sets a reference input voltage.

Notes	When selected, dBm measurements are frozen, and a dBr indicator appears. The dBr indicates the normalized measurement between the reference input voltage and the current input voltage.
-------	--

Clear dBr Reference (Voltmeter submenu)

When the meter is set to Voltmeter and Voltmeter mode is set to AC, pressing this soft key clears the dBr reference input voltage.

Voltage Units (Voltmeter submenu)

When the meter is set to Voltmeter, pressing this soft key activates a horizontal soft key menu where you can select the power meter range.

Discrete Values	Volts (V), Millivolts (mV), Decibel Volts (dBV)
Default	Volts (V)
Saved State	Saved with instrument state

DC Range (Voltmeter submenu)

When the meter is set to Voltmeter, pressing this soft key activates a horizontal soft key menu where you can select the power meter DC voltage range.

Discrete Values	Auto, 1 V, 10 V, 70 V
Default	Auto
Saved State	Saved with instrument state
Notes	The range on AC and DC must be 1 or 10 Volts to use 600 Ohm Input Impedance.

RF Scan (METER Zone menu)

Opens the RF Scan display and submenu.

Start Frequency (RF Scan submenu)

When the meter is set to RF Scan, pressing this key displays the Start Frequency dialog where you can input the start frequency to be used in the RF scan.

Range	1 to 2991 MHz
Default	400 MHz
Saved State	Saved with instrument state

Stop Frequency (RF Scan submenu)

When the meter is set to RF Scan, pressing this key displays the Stop Frequency dialog where you can input the start frequency to be used in the RF scan.

Range	1 to 2991 MHz
Default	600 MHz
Saved State	Saved with instrument state

Scan (RF Scan submenu)

When the meter is set to RF Scan, pressing this soft key activates a horizontal soft key menu where you can select the scanning mode.

Discrete Values	Off, Single, Auto
Default	Off
Saved State	Saved with instrument state
Notes	Off – Deactivates scanning. Single – Sweep the span defined by the Start and Stop Frequency parameters once. Auto – Continuously sweeps the span defined by the Start and Stop Frequency parameters. The signal captured by the scan will automatically set the Monitor Frequency to the closest channel in the selected RF Bandwidth. For example, if the signal captured by the receiver in a 12.5 kHz BW is 390.011911 kHz, then the Monitor Frequency will be set to 390.0125 (i.e., the ideal channel frequency). This ensures that the Frequency Error meter will display the offset from this ideal.

dPMR Zone Soft Keys for Receiver Test

During dPMR receiver tests, the dPMR Zone contains controls for the dPMR transmitter. These tests are performed with the R8200 in Generate Mode.

Test Pattern (dPMR submenu)

Provides selection of bit patterns for testing the radio in Receive Mode.

Discrete Values	Calibration (0.153 2%), 511 (0.153), Interference, Max Freq Deviation, 1/3 Freq Deviation
Default	Calibration (0.153 2%)
Saved State	Saved with instrument state
Notes	<p>Some test patterns may require the radio to be under RSS control. The following are available:</p> <p>Calibration (0.153 2%) is the test pattern derived from the 511 (0.153) pattern to yield a 2.005871% BER used to verify BER measurements are operating correctly.</p> <p>511 (0.153) is the unframed test pattern of continuously repeating 511-bit pseudo random number sequences generated with a nine-bit shift register (PN9) based on ITU-T 0.153 (formerly CCITT V.52) used to perform BER testing for checking the modulation, encoding, and timing of the transmit signal (dPMR CAI compliant).</p> <p>Interference, Interfering Modulation Data Stream is a 32767-bit pseudo-random number pattern defined by ITU-T.</p> <p>Max Freq Deviation is the maximum frequency deviation test pattern of a continuously repeating stream of high deviation symbols (+3, +3, -3, -3, ...).</p> <p>1/3 Freq Deviation is the test pattern of a continuously repeating stream of low deviation symbols (+1, +1, -1, -1, ...) for a 1/3 maximum frequency deviation.</p>

Modulation Mode (dPMR submenu)

Activates a horizontal menu where you can choose the modulation mode for the selected Test Pattern modulation.

Discrete Values	Off, Continuous, Burst
Default	Off

Saved State	Saved with instrument state
Notes	Enabling a test pattern in Generate Mode will erase any previously captured Voice Recordings.

Ideal Sym Dev (dPMR submenu)

Opens the Ideal Sym Dev dialog where you can set the ideal symbol deviation for the modulation.

Range	800 Hz to 2400 Hz
Default	1050 Hz
Saved State	Saved with instrument state

Filter (dPMR submenu)

Activates a horizontal soft key menu where you can control the filter type.

Discrete Values	ETSI, PDR
Default	ETSI
Saved State	Saved with instrument state

P25 II Zone Soft Keys

This section contains detailed descriptions of the soft keys accessible in the P25 II Zone during transmitter testing with the R8200 in Monitor Mode, and receiver testing with the R8200 in Generate Mode. Each P25 II soft key is defined, along with its range, discrete, default, and saved state values.

"P25 II Zone Soft Keys for Transmitter Test" on the next page includes the parameters associated with testing the P25 Phase 2 radio's transmitter with the R8200 in Monitor Mode. For standard Monitor Mode soft key definitions, see **"8 Monitor Mode Soft Keys" on page 351**.

"DISPLAY Zone Soft Keys for P25 Phase 2 Transmitter Test" on page 745 includes the parameters associated with specialized display configurations for quick visual verification of P25 Phase 2 transmitter performance. For standard DISPLAY Zone soft key definitions, see **"DISPLAY Zone Soft Keys for Monitor Mode" on page 383**.

"METER Zone Soft Keys for P25 Phase 2 Transmitter Test" on page 752 includes the parameters associated with specialized metering configurations offering focused presentations of basic RF and baseband P25 Phase 2 transmitter characteristics. For standard METER Zone soft key definitions, see **"METER Zone Soft Keys for Monitor Mode" on page 401**.

"P25 II Zone Soft Keys for Receiver Test" on page 756 includes the parameters associated with testing the P25 Phase 2 radio's receiver with the R8200 in Generate Mode. For standard Generate Mode soft key definitions, see **"9 Generate Mode Soft Keys" on page 411**.

P25 II Zone Soft Keys for Transmitter Test

During P25 Phase 2 transmitter tests, the P25 II Zone contains controls for the P25 Phase 2 receiver. These tests are performed with the R8200 in Monitor Mode.

Test Pattern (P25 II submenu)

Provides selection for one of three TIA-102.CCAA compliant predefined test patterns for BER testing of a P25 Phase 2 radio in Monitor Mode.

Discrete Values	1031 Hz Tone, Calibration (Tone 5%), Silence
Default	1031 Hz Tone
Saved State	Saved with instrument state
Notes	<p>Each measurement uses an ultraframe (four consecutive superframes) of data. Outbound uses 10880 bits (0.009%/bit); inbound uses from 7252 to 7536 bits (~0.013%/bit) if there is no random-access SAACH to exclude.</p> <p>1031 Hz Tone is the standard tone framed test pattern of the 1031 Hz vocoder tone for either modulation type and both logical channels.</p> <p>Calibration (Tone 5%) is the test pattern derived from the standard 1031 Hz Tone test pattern to verify BER measurements are operating correctly for either modulation type and both logical channels. The first of every 20 bits is inverted. However, the inbound BER is 4.992% if a random-access SACCH is received or 4.989% if not (rather than 5% since some of the 20 bits are not to be included in the comparison).</p> <p>Silence is the framed test pattern for silence at the vocoder for either modulation type and both logical channels.</p>

Monitor Modulation Type (P25 II menu)

Selects the type of modulation of the received signal to be analyzed.

Discrete Values	HCPM, HDQPSK
Default	HCPM
Saved State	Saved with instrument state
Notes	HCPM (inbound) or HDQPSK (outbound). The type specified is also used in the DISPLAY Zone to enable selection of the Power Profile for inbound frames.

BER Test (P25 II menu)

Activates a horizontal soft key menu where you can control the operating state of bit error rate testing.

Discrete Values	Stop, Start
Default	Stop
Saved State	Saved with instrument state
Notes	When performing the BER test, the radio transmitter under test must be placed in a Test Diagnostic Mode using the manufacturer's Radio Service Software (RSS). The transmission is compared against the Test Pattern specified in the P25 II submenu. BER test results are shown as an error in % in the P25 II Zone.

DISPLAY Zone Soft Keys for P25 Phase 2 Transmitter Test

The DISPLAY Zone offers specialized displays during P25 Phase 2 transmitter testing with the R8200 in Monitor Mode. Their associated soft keys are described below.

Select Display (DISPLAY Zone menu)

Activates a horizontal soft key menu where you can select the display mode.

Discrete Values	Spec An, Oscilloscope, Bar Graphs, Eye Diagram, Power Profile, Distribution Plot
Default	Spec An
Saved State	Saved with instrument state

Eye Diagram (DISPLAY Zone menu)

The Eye Diagram provides a visual display of the received signal and overlays the modulation response during two symbol periods over the yellow target crossing points for an ideal signal. The Eye Diagram can indicate whether a transmitter has significant unbalances or offsets in the modulation circuitry by noting how tightly grouped the waveform is around the crossing points. Be sure that the Modulation Type in the P25 II Zone is set for the expected receive signal in order to establish the appropriate number of crossing points and symbol timing used to position the diagram on the horizontal axis. The center of the display is at symbol times for HDQPSK but halfway between symbol times for HCPM. Some overshoot caused by ISI is expected, more for HCPM. View the Eye Diagram with the other P25 measurements on the main screen by selecting it in the DISPLAY Zone.

Display Mode (Eye Diagram submenu)

When the display is set to Eye Diagram, pressing this soft key activates a horizontal soft key menu where you can select the Eye Diagram display mode.

Discrete Values	Normal, Fade Away
Default	Normal
Saved State	Saved with instrument state
Notes	The following horizontal menu choices: Normal allows the display to update continuously.

	<p>Fade Away is similar to the Persistence Mode on an oscilloscope. The intensity of each trace fades away or decays as new traces are received. The effect is to intensify the display in the area where the waveform spends most of its time.</p> <p>Whenever the Display Mode is changed, the R8200 reconfigures the presentation. This process takes approximately 10 seconds and is complete when the new setting appears in the Display Mode field.</p>
--	---

Power Profile (DISPLAY Zone menu)

Provides a power versus time plot for an HCPM transmitter (null slots are not transmitted for HDQPSK).

Saved State	Saved with instrument state
Notes	<p>The display is useful in assuring that near-far situations will not result in co-channel inter-slot interference on the alternate or non-transmission slot and that the power level will be adequate for acceptable BER performance. The scaling and position of the vertical power axis can be adjusted to inspect greater range or detail. The horizontal axis can be changed to view one or both slots, including the additional ramp up/down time. Display functions and markers are available for advanced analysis. Overlays of slot centers and burst time regions are shown.</p> <p>See the transmitter power envelope standard: TIA-102.CCAA 2.2.17.3 TDMA Method of Measurement.</p>

Select View (Power Profile submenu)

Selects the timeslot(s) to view.

Discrete Values	Frame, Slot 1, Slot 2
-----------------	-----------------------

Default	Frame
Saved State	Saved with instrument state
Notes	<p>Although slots are alternating 30 milliseconds, the profile for a slot is 30.4 ms, divided into three regions for ramp-up (1.2 ms), burst (28.0 ms), and ramp-down (1.2 ms).</p> <p>Frame – Displays the horizontal axis – 0.2 ms to 60.2 ms with slots from 0 to 30 and 30 to 60 ms.</p> <p>Slot 1 – Displays the horizontal axis – 0.2 ms to 30.2 ms with slot from 0 to 30 ms.</p> <p>Slot 2 – Displays the horizontal axis 29.8 ms to 60.2 ms with slot from 30 to 60 ms. Ramp up/- down times for a slot overlap the adjacent slots by 0.2 milliseconds.</p>

Select Frame (Power Profile submenu)

Selects which frame of a superframe to view.

Discrete Values	1, 2, 3, 4, 5, 6
Default	1
Saved State	Saved with instrument state
Notes	See the asymmetrical superframe structure in Table 2.2.7.8.1.4-1. P25 Phase 2 Logical Channels (Inbound).

Vertical Maximum (Power Profile submenu)

When the display is set to Power Profile, pressing this soft key opens the Vertical Scale dialog where you can adjust the maximum level for the top line of the vertical scale of the display.

Range	-120 dBm to +60 dBm in 1 dB increments
Default	50 dBm
Saved State	Saved with instrument state

Vertical Scale (Power Profile submenu)

When the display is set to Power Profile, pressing this soft key opens a horizontal soft key menu where you can select the vertical scale resolution for the display's major grid lines.

Discrete Values	10 dB/div, 5dB/div, 2 dB/div, 1 dB/div
Default	10 dB/div
Saved State	Saved with instrument state

Display Mode (Power Profile submenu)

When the display is set to Power Profile, pressing this soft key opens a horizontal soft key menu where you can select the display mode.

Discrete Values	Normal, Freeze, Max Hold, Average
Default	Normal
Saved State	Saved with instrument state
Notes	Normal – Display to updates continuously.

	<p>Freeze – Snapshot of the current display indication and stops additional updates.</p> <p>Max Hold – Display to retain the highest peak signal amplitudes measured during successive sweeps.</p> <p>Average – Displays signal amplitudes as a rolling average of the peak amplitudes measured on each successive sweep. The average consists of one to five sweeps, shown beside the mode indication.</p>
--	---

Marker Mode (Power Profile submenu)

When the display is set to Power Profile, pressing this soft key activates a horizontal soft key menu where you can select the Marker type and operating state.

Discrete Values	Off, Absolute, Delta, Delta dBm
Default	Off
Saved State	Saved with instrument state
Notes	<p>Off – Deactivates markers.</p> <p>Absolute – Displays the frequency and absolute signal amplitude for each marker selected.</p> <p>Delta – Displays the frequency and amplitude difference between each pair of markers selected.</p> <p>Delta dBm – Displays the amplitude difference between each pair of markers selected.</p> <p>Depending on the installed options, up to four markers can be enabled and selected for positioning.</p>

Toggle Marker (Power Profile submenu)

When the display is set to Power Profile, pressing this soft key cycles through the available markers to select the active (yellow) marker for positional adjustment on the display.

Saved State	Saved with instrument state
Notes	The active marker is moved using the horizontal arrow keys.

Distribution Plot (DISPLAY Zone menu)

Displays a graph showing the distribution of symbol deviations of the received signal grouped into frequency bins, i.e., the frequency offset versus the rate of occurrence of that frequency (~10 Hz for HDQPSK; ~12 Hz for HCPM).

Saved State	Saved with instrument state
Notes	<p>Each plot consists of about two seconds of the most current data available.</p> <p>HDQPSK consists of four symbol values (-3, -1, +1, +3) at proportional carrier deviations. The four ideal symbol deviations are labeled at gridlines with additional gridlines half way between them, dividing the plot into four equal regions and marking the thresholds where symbol decisions change from one to the other. For example, in low power conditions, noise may cause a symbol's deviation to appear in the adjacent region, thus causing a bit error.</p> <p>Be sure that the Modulation Type in the P25 II Test Zone is set for the expected receive signal in order to establish the appropriate horizontal range and symbol timing used to sample the deviation appropriately. Sampling is at symbol times for HDQPSK but halfway between symbol times for HCPM. ISI inherent in the modulations causes some overshoot exhibited by groups being further from center and having multiple peaks.</p> <p>All distribution amounts are displayed by automatic adjustment of the vertical axis scaling to show the full amount of symbols falling into each bin. Distribution amounts are the percentage of</p>

	the number of symbols whose deviation falls within that point's frequency bin based on the number of symbols in the analysis population. The better a signal is, the more symbols will actually land in the ideal bin to increase its percentage. Deviations that are past the graph edge limits (e.g., for noise if there is no signal) are collected and shown in the bin at the limit.
--	---

METER Zone Soft Keys for P25 Phase 2 Transmitter Test

The METER Zone offers specialized meters during P25 Phase 2 transmitter testing with the R8200 in Monitor Mode. Their associated soft keys are described below.

Power Meter (METER Zone menu)

Opens the Power Meter display and submenu.

Range (Power Meter submenu)

When the meter is set to Power Meter, pressing this soft key activates a horizontal soft key menu where you can select the power meter range.

Discrete Values	5, 10, 50, 150 W
Default	50 W
Saved State	Saved with instrument state
Notes	For best accuracy, disable the Pre-amplifier in Monitor Mode and set the Gen Port in Generate Mode to RF In/Out.

Voltmeter (METER Zone menu)

Opens the Voltmeter display and submenu.

Select Voltmeter Mode (Voltmeter submenu)

When the meter is set to Voltmeter, pressing this soft key activates a horizontal soft key menu where you can select the voltage mode for the Voltmeter.

Discrete Values	AC Volts, DC Volts
Default	AC Volts
Saved State	Saved with instrument state
Notes	AC Volts measures AC voltage applied to the Meter In port. The dBm computation assumes an impedance of 600Ω.

Coupling (Voltmeter submenu)

When the meter is set to Voltmeter, pressing this soft key activates a Coupling dialog menu where you can select the input voltage coupling.

Discrete Values	DC, AC
Default	DC
Saved State	Saved with instrument state

AC Range (Voltmeter submenu)

When the meter is set to Voltmeter, pressing this soft key activates a horizontal soft key menu where you can select the power meter AC voltage range.

Discrete Values	Auto, 1 V, 10 V, 70 V
Default	Auto
Saved State	Saved with instrument state
Notes	The range on AC and DC must be 1 or 10 Volts to use 600 Ohm Input Impedance.

Set dBr Reference (Voltmeter submenu)

When the meter is set to Voltmeter and Voltmeter mode is set to AC, pressing this soft key sets a reference input voltage.

Notes	When selected, dBm measurements are frozen, and a dBr indicator appears. The dBr indicates the normalized measurement between the reference input voltage and the current input voltage.
-------	--

Clear dBr Reference (Voltmeter submenu)

When the meter is set to Voltmeter and Voltmeter mode is set to AC, pressing this soft key clears the dBr reference input voltage.

Voltage Units (Voltmeter submenu)

When the meter is set to Voltmeter, pressing this soft key activates a horizontal soft key menu where you can select the power meter range.

Discrete Values	Volts (V), Millivolts (mV), Decibel Volts (dBV)
Default	Volts (V)
Saved State	Saved with instrument state

DC Range (Voltmeter submenu)

When the meter is set to Voltmeter, pressing this soft key activates a horizontal soft key menu where you can select the power meter DC voltage range.

Discrete Values	Auto, 1 V, 10 V, 70 V
Default	Auto
Saved State	Saved with instrument state
Notes	The range on AC and DC must be 1 or 10 Volts to use 600 Ohm Input Impedance.

Constellation (METER Zone menu)

Provides a visual representation of overall transmitter operation.

Saved State	Saved with instrument state															
Notes	<p>DMR radios broadcast voice and data using four frequency shift deviations of the carrier to represent symbols containing two data bits. Four red tick marks on the display represent the expected locations for the deviation states when the radio is transmitting data bit symbols using the modulation. White bars show the actual deviation measurement at symbol decision times. A tighter grouping around the red tick marks indicates more accurate transmitter performance.</p> <p>The nominal deviation points for each data symbol are as follows:</p> <table border="1"><thead><tr><th>Bits</th><th>Symbol</th><th>Deviation</th></tr></thead><tbody><tr><td>01</td><td>+3</td><td>+1944 Hz</td></tr><tr><td>00</td><td>+1</td><td>+648 Hz</td></tr><tr><td>10</td><td>-1</td><td>-648 Hz</td></tr><tr><td>11</td><td>-3</td><td>+1944 Hz</td></tr></tbody></table>	Bits	Symbol	Deviation	01	+3	+1944 Hz	00	+1	+648 Hz	10	-1	-648 Hz	11	-3	+1944 Hz
Bits	Symbol	Deviation														
01	+3	+1944 Hz														
00	+1	+648 Hz														
10	-1	-648 Hz														
11	-3	+1944 Hz														

P25 II Zone Soft Keys for Receiver Test

During P25 Phase 2 receiver tests, the P25 II Zone contains controls for the P25 Phase 2 transmitter. These tests are performed with the R8200 in Generate Mode.

Test Pattern (P25 II submenu)

Provides selection for one of six TIA-102.CCAA compliant predefined bit patterns for BER testing of a P25 Phase 2 radio in Receive Mode.

Discrete Values	1031 Hz Tone, Calibration (Tone 5%), Silence, High Deviation, Low Deviation, Interference
Default	1031 Hz Tone
Saved State	Saved with instrument state
Notes	<p>The following patterns are available:</p> <p>1031 Hz Tone – Standard tone framed test pattern of the 1031 Hz vocoder tone for either modulation type and both logical channels.</p> <p>Calibration (Tone 5%) – Derived from the standard 1031 Hz Tone test pattern to verify BER measurements are operating correctly for both modulation types and both logical channels. The first of every 20 bits is inverted (i.e., ~5%).</p> <p>Silence – Framed test pattern for silence at the vocoder for either modulation type and both logical channels.</p> <p>High Deviation – Unframed maximum frequency deviation test pattern of a continuously repeating stream of high deviation symbols (+3, +3, -3, -3, ...).</p> <p>Low Deviation – Unframed test pattern of a continuously repeating stream of low deviation symbols (+1, +1, -1, -1, ...) for a 1/3 maximum frequency deviation.</p> <p>Interference – Unframed standard interference test pattern as defined by the phase 2 standard and described by the phase 1 (C4FM) standard as yielding a silence output at the receiver vocoder and balanced to have approximately equal positive and negative signal deviations.</p>

Generate Modulation Type (P25 II submenu)

Selects the desired type of modulation for the generated signal required by the receiver.

Discrete Values	HCPM, HDQPSK
Default	HCPM
Saved State	Saved with instrument state

Modulation Mode (P25 II submenu)

Provides choice of Test Pattern modulation.

Discrete Values	Off, Continuous, Burst
Default	Off
Saved State	Saved with instrument state

LCH (P25 II submenu)

Selects which logical channel for the transmitter to use (HCPM only), with ramp down to no power (unused null slot) and ramp up to the next used slot.

Discrete Values	0, 1
Default	0

Saved State	Saved with instrument state
Notes	The logical channel uses either time slot according to the asymmetrical superframe format.

PTC-ITCR Zone Soft Keys

This section contains detailed descriptions of the soft keys accessible in the PTC-ITCR Zone during transmitter testing with the R8200 in Monitor Mode, and receiver testing with the R8200 in Generate Mode. Each PTC-ITCR soft key is defined, along with its range, discrete, default, and saved state values.

"PTC-ITCR Zone Soft Keys for Transceiver Test" on the next page includes the parameters associated with testing the PTC-ITCR radio's transceiver with the R8200 in Generate and Duplex Mode. For standard Generate Mode soft key definitions, see **"9 Generate Mode Soft Keys" on page 411**. For Duplex Mode, see **"10 Duplex Mode Soft Keys" on page 461**.

"DISPLAY Zone Soft Keys for PTC-ITCR Transceiver Test" on page 761 includes the parameters associated with specialized display configurations for quick visual verification of PTC-ITCR transmitter performance. For standard DISPLAY Zone soft key definitions, see **"DISPLAY Zone Soft Keys for Monitor Mode" on page 383**.

"METER Zone Soft Keys for PTC-ITCR Transceiver Test" on page 762 includes the parameters associated with specialized metering configurations offering focused presentations of basic RF and baseband PTC-ITCR transmitter characteristics. For standard METER Zone soft key definitions, see **"METER Zone Soft Keys for Monitor Mode" on page 401**.

PTC-ITCR Zone Soft Keys for Transceiver Test

During PTC-ITCR Test Mode, the PTC-ITCR Zone contains controls for the PTC-ITCR transceiver. These tests are performed with the R8200 in Generate and Duplex Mode.

Mon Symbol Rate (PTC-ITCR submenu)

Opens the Mon Symbol Rate dialog where you can select the monitor symbol rate.

Discrete Values	8000, 16000 sps
Default	16000 sps
Saved State	Saved with instrument state

Gen Symbol Rate (PTC-ITCR submenu)

Opens the Gen Symbol Rate dialog where you can select the Generator Symbol Rate.

Discrete Values	8000, 16000 sps
Default	8000 sps
Saved State	Saved with instrument state

BER Test (PTC-ITCR submenu)

Activates a horizontal soft key menu where you can control the operating state of Bit Error Rate Testing.

Discrete Values	Stop, Start
Default	Stop
Saved State	Saved with instrument state
Notes	This bit error rate test checks the modulation, encoding, and timing of the transmit signal during the data transmission period. When the BER Test is running, the radio transmitter under test must be placed into a Test Diagnostic Mode with the correct TX test pattern selected using the manufacturer's Radio Service Software (RSS). The test is done at nominal power with the radio transmitting the Standard 0.153 super frame test pattern into the service monitor. (It is acceptable to have an attenuator between the radio under test and the service monitor.) BER test results, the percentage of bit differences between the Standard 0.153 pattern and the bits of the synchronized TDMA slot of the received signal, are shown in the PTC-ITCR Zone BER field.

Modulation Mode (PTC-ITCR submenu)

Activates a horizontal soft key menu where you can enable and disable PTC-ITCR modulation.

Discrete Values	Off, Continuous
Default	Off
Saved State	Saved with instrument state

DISPLAY Zone Soft Keys for PTC-ITCR Transceiver Test

The DISPLAY Zone offers specialized displays during PTC-ITCR transmitter testing with the R8200 in Monitor Mode. Their associated soft keys are described below.

Select Display (DISPLAY Zone menu)

Pressing this soft key activates a horizontal soft key menu where you can select the display mode.

Discrete Values	Spec An, Eye Diagram, Power Profile, Constellation Plot, Distribution Plot
Default	Power Profile
Saved State	Saved with instrument state
Notes	Spec An is only available in Monitor Mode.

Spectrum Analyzer (DISPLAY Zone menu)

For Spectrum Analyzer soft key descriptions, see ["Spectrum Analyzer Soft Keys" on page 525](#).

Eye Diagram (DISPLAY Zone menu)

For Eye Diagram soft key descriptions, see ["Eye Diagram \(DISPLAY Zone menu\)" on page 602](#).

Power Profile (DISPLAY Zone menu)

For Power Profile soft key descriptions, see ["Power Profile \(DISPLAY Zone menu\)" on page 603](#).

Constellation Plot (DISPLAY Zone menu)

For Constellation Plot soft key descriptions, see ["Constellation Plot \(DISPLAY Zone menu\)" on page 621](#)

Distribution Plot (DISPLAY Zone menu)

For Distribution Plot soft key descriptions, see ["Distribution Plot \(DISPLAY Zone menu\)" on page 622](#).

METER Zone Soft Keys for PTC-ITCR Transceiver Test

The METER Zone offers specialized meters during PTC-ITCR transmitter testing with the R8200 in Monitor Mode. Their associated soft keys are described below.

Constellation (METER Zone menu)

Provides a visual representation of overall transmitter operation.

Saved State	Saved with instrument state															
Notes	<p>PTC-ITCR radios broadcast voice and data using four frequency shift deviations of the carrier to represent symbols containing two data bits. Four red tick marks on the display represent the expected locations for the deviation states when the radio is transmitting data bit symbols using the modulation. White tick marks show the actual deviation measurement at symbol decision times. A tighter grouping around the red tick marks indicates more accurate transmitter performance.</p> <p>The nominal deviation points for each data symbol are as follows:</p> <table border="1" data-bbox="402 646 1393 877"> <thead> <tr> <th data-bbox="402 646 711 688">Bits</th> <th data-bbox="711 646 1052 688">Symbol</th> <th data-bbox="1052 646 1393 688">Deviation</th> </tr> </thead> <tbody> <tr> <td data-bbox="402 688 711 730">01</td> <td data-bbox="711 688 1052 730">+3</td> <td data-bbox="1052 688 1393 730">+ 3000 Hz</td> </tr> <tr> <td data-bbox="402 730 711 772">00</td> <td data-bbox="711 730 1052 772">+1</td> <td data-bbox="1052 730 1393 772">+ 1000 Hz</td> </tr> <tr> <td data-bbox="402 772 711 814">10</td> <td data-bbox="711 772 1052 814">-1</td> <td data-bbox="1052 772 1393 814">- 1000 Hz</td> </tr> <tr> <td data-bbox="402 814 711 877">11</td> <td data-bbox="711 814 1052 877">-3</td> <td data-bbox="1052 814 1393 877">+ 3000 Hz</td> </tr> </tbody> </table>	Bits	Symbol	Deviation	01	+3	+ 3000 Hz	00	+1	+ 1000 Hz	10	-1	- 1000 Hz	11	-3	+ 3000 Hz
Bits	Symbol	Deviation														
01	+3	+ 3000 Hz														
00	+1	+ 1000 Hz														
10	-1	- 1000 Hz														
11	-3	+ 3000 Hz														

PTC-ACSES Zone Soft Keys

This chapter contains detailed descriptions of the soft keys accessible in the PTC-ACSES Zone during transmitter testing with the R8200 in Monitor Mode, and receiver testing with the R8200 in Generate Mode. Each PTC-ACSES soft key is defined, along with its range, discrete, default, and saved state values.

"PTC-ACSES Zone Soft Keys for Transceiver Test" on the next page includes the parameters associated with testing the PTC-ACSES radio's transmitter with the R8200 in Monitor Mode. For standard Monitor Mode soft key definitions, see **"8 Monitor Mode Soft Keys" on page 351**.

"DISPLAY Zone Soft Keys for PTC-ACSES Transceiver Test" on page 771 includes the parameters associated with specialized display configurations for quick visual verification of PTC-ACSES transmitter performance. For standard DISPLAY Zone soft key definitions, see **"DISPLAY Zone Soft Keys for Monitor Mode" on page 383**.

"METER Zone Soft Keys for PTC-ACSES Transceiver Test" on page 772 includes the parameters associated with specialized metering configurations offering focused presentations of basic RF and baseband PTC-ACSES transmitter characteristics. For standard METER Zone soft key definitions, see **"METER Zone Soft Keys for Monitor Mode" on page 401**.

PTC-ACSES Zone Soft Keys for Transceiver Test

These tests are performed with the R8200 in Duplex Mode. During PTC-ACSES Test Mode, the PTC-ACSES Zone contains controls for the PTC-ACSES transceiver.

Test Pattern (PTC-ACSES submenu)

Provides selection of bit patterns for testing the radio in Transmit Mode while under Radio Service Software (RSS) control.

Discrete Values	Standard, Calibration (0.153 5%)
Default	Standard
Saved State	Saved with instrument state
Notes	Standard selects the standard transmitter test pattern of continuously repeating 511-bit pseudo random number sequences based on ITU-T 0.153 (formerly CCITT V.52). Calibration (0.153 2%) is a test pattern derived from the 511 (0.153) pattern to yield a 2.005871% BER used to verify BER measurements are operating correctly.

Radio Tx (PTC-ACSES submenu)

Opens a horizontal soft key menu offering operating mode choices for radio transmission.

Discrete Values	Off, Continuous
Default	Off
Saved State	Saved with instrument state

Modulation Mode (PTC-ACSES submenu)

Opens a horizontal soft key menu offering operating mode choices for Test Pattern modulation.

Discrete Values	Off, Continuous
Default	Off
Saved State	Saved with instrument state

Gen Symbol Deviation (PTC-ACSES submenu)

Opens the Gen Symbol Deviation dialog offering settings for the generator symbol deviation.

Discrete Values	Narrow, Wide
Default	Narrow
Saved State	Saved with instrument state

Gen Bit Errs (PTC-ACSES submenu)

Opens the Gen Bit Errs dialog offering settings for number of bit errors per timeslot.

Range	0 to 360
Default	0
Saved State	Saved with instrument state

BER Test (PTC-ACSES submenu)

Controls the operating state of Bit Error Rate (BER) testing.

Discrete Values	Stop, Start
Default	Stop
Saved State	Saved with instrument state
Notes	This Bit Error Rate test checks the modulation, encoding, and timing of the transmit signal during the data transmission period. When performing the BER Test, the radio transmitter under test must be placed into a test diagnostic mode with the correct TX test pattern selected using the manufacturer's Radio Service Software (RSS). The test is done at nominal power with the radio transmitting the test pattern into the service monitor. (It is acceptable to have an attenuator between the radio under test and the service monitor.) BER test results, the percentage of bit differences between the bits of the selected Test Pattern and the bits from the received synchronized FDMA signal, are shown in the PTC-ACSES Zone in the BER field.

Reset Tests (PTC-ACSES submenu)

Returns all measurements to default values.

Radio Configuration (PTC-ACSES submenu)

Opens the Radio Configuration table and submenu.

Power Level (Radio Configuration submenu)

Opens the Power Level dialog where you can set the power level of the radio under test.

Range	2 W to 25 W
Default	2 W
Saved State	Saved with instrument state

Duty Cycle (Radio Configuration submenu)

Opens the Duty Cycle dialog where you can set percentage for the duty cycle.

Discrete Values	100 %, 50 %, 25 %
Default	100 %
Saved State	Saved with instrument state

Timing (Radio Configuration submenu)

Opens the Timing dialog where you can set the timing source.

Discrete Values	OTA, GPS/PTP
Default	OTA
Saved State	Saved with instrument state

Tx Frequency (Radio Configuration submenu)

Opens the Tx Frequency dialog where you can set the frequency of the transmitter.

Range	250 kHz to 1 GHz
Default	500 kHz
Saved State	Saved with instrument state

Rx Frequency (Radio Configuration submenu)

Opens the Rx Frequency dialog where you can set the frequency of the receiver.

Range	250 kHz to 1 GHz
Default	500 kHz
Saved State	Saved with instrument state

IP Address (Radio Configuration submenu)

Opens IP Address dialog where you can set the IP Address for the radio under test.

Discrete Values	(a valid IP address)
Default	169.254.0.0
Saved State	Saved with instrument state

Tx Port (Radio Configuration submenu)

Opens the Tx Port dialog where you can set the transmit port value for the radio under test.

Range	0 to 65535
Default	50000
Saved State	Saved with instrument state

Rx Port (Radio Configuration submenu)

Opens the Rx Port dialog where you can set the receive port value for the radio under test.

Range	0 to 65535
Default	50001
Saved State	Saved with instrument state

ID (Radio Configuration submenu)

Opens the ID dialog where you can set the identifier for the radio under test.

Range	0 to 4294967295
Default	1
Saved State	Saved with instrument state

Data Logging (PTC-ACSES submenu)

Opens the Data Logging dialog where you can enable or disable data logging for the radio under test.

Discrete Values	Off, On
Default	Off
Saved State	Saved with instrument state

DISPLAY Zone Soft Keys for PTC-ACSES Transceiver Test

The DISPLAY Zone offers specialized displays during PTC-ACSES transmitter testing with the R8200in Monitor Mode. Their associated soft keys are described below.

Select Display (DISPLAY Zone menu)

Pressing this soft key activates a horizontal soft key menu where you can select the display mode.

Discrete Values	Spec An, Eye Diagram, Power Profile, Slot Map
Default	Spec An
Saved State	Saved with instrument state
Notes	Spec An is only available in Monitor Mode.

Spectrum Analyzer (DISPLAY Zone menu)

For Spectrum Analyzer soft key descriptions, see ["Spectrum Analyzer Soft Keys" on page 525](#).

Eye Diagram (DISPLAY Zone menu)

For Eye Diagram soft key descriptions, see ["Eye Diagram \(DISPLAY Zone menu\)" on page 602](#).

Power Profile (DISPLAY Zone menu)

For Power Profile soft key descriptions, see ["Power Profile \(DISPLAY Zone menu\)" on page 603](#).

Slot Map (DISPLAY Zone menu)

Opens the Slot Map where you can monitor timeslot error status by slot.

Data Type (Slot Map submenu)

Opens the Data Type dialog where you can choose between packet or bit error rate.

Discrete Values	PERs, BERs
Default	PERs
Saved State	Saved with instrument state
Notes	The selection of reported data is displayed in top right of slot map.

Reset (Slot Map submenu)

Resets all the displays on the Slot Map.

METER Zone Soft Keys for PTC-ACSES Transceiver Test

The METER Zone offers specialized meters during PTC-ACSES transmitter testing with the R8200 in Monitor Mode. Their associated soft keys are described below.

Constellation (METER Zone menu)

Provides a visual representation of overall transmitter operation.

Saved State	Saved with instrument state
-------------	-----------------------------

Notes

PTC-ACSES radios broadcast voice and data using Gaussian Minimum Shift Keying (GMSK) modulation composed of four frequency shift deviations of the carrier to represent symbols containing two data bits. Four red tick marks on the display represent the expected locations for the deviation states when the radio is transmitting data bit symbols using the modulation. White tick marks show the actual deviation measurement at symbol decision times. A tighter grouping around the red tick marks indicates more accurate transmitter performance.

The nominal deviation points for each data symbol are as follows:

Bits	Symbol	Deviation
01	+3	+3000 Hz
00	+1	+1500 Hz
10	-1	-1500 Hz
11	-3	3000 Hz

AVIONICS Test Mode Soft Keys

This section contains detailed descriptions of the soft keys accessible in AVIONICS Test Mode. Each AVIONICS soft key is defined, along with its range, discrete, default, and saved state values.

Select Signal (AVIONICS submenu)

Chooses the signal type for the radio under test.

Discrete Values	Localizer, Glide Slope, Markers, NDB/ADF, VOR, Selcal
Default	Localizer
Saved State	Saved with instrument state

Localizer (AVIONICS submenu)

Opens the Localizer display and submenu.

Glide Slope (AVIONICS submenu)

Opens the Glide Slope display and submenu.

Markers (AVIONICS submenu)

Opens the Markers display and submenu.

Saved State	Saved with instrument state
Notes	The Marker Beacon signal generates a continuous carrier at 75 MHz (default) amplitude modulated by a single tone. There are three user-selected tones from which to select. During start up, none of the beacon markers are selected by default. After selection of one the three markers (Outer, Middle, Inner), a continuous corresponding pure sine wave will transmit via the selected RF port.

NDB/ADF (AVIONICS submenu)

Opens the NDB/ADF display and submenu.

Saved State	Saved with instrument state
Notes	The Non-Directional Beacon/Automatic Direction Finder (NDB/ADF) signal transmits a 30 MHz (default) amplitude modulated by a Morse code string.

VOR (AVIONICS submenu)

Opens the VOR display and submenu.

Saved State	Saved with instrument state
Notes	<p>Transmits a short/medium range navigation signal operating in the 108 to 117.95 MHz range of frequencies (with 50 kHz channel spacing).</p> <p>The VOR signal provides the aircraft with a bearing to the ground station location. The VOR signal may optionally include a three-letter code (derived from an Airport name, for example: London VOR is, "LON" and Dover VOR is, "DVR"). The code is modulated onto the carrier with a 1020 Hz tone that the crew can listen to as a Morse code signal. As VOR operates in the same frequency range as the ILS system (108 to 111.95 MHz), the two systems are differentiated by their frequency allocation within this range. VOR frequencies are allocated where the 100 kHz digit is always even for each of the 50 kHz increments (for example: 109.00, 109.05, 109.20, and 109.25 MHz, etc.). This pattern is applied from 108 to 111.95 MHz.</p> <p>Of the two types of VOR, Conventional and Doppler, the Freedom R8200 only supports the Conventional VOR Transmission. The conventional VOR (CVOR) station transmits two signals, omnidirectional and directional, on a continuous basis. The omnidirectional (reference) signal is the carrier wave frequency of the station, which contains a modulated continuous wave (MCW), 7-word-per-minute, Morse code station identifier and an AM voice channel. The 30 Hz reference</p>

	<p>signal is frequency-modulated on a 9960 Hz subcarrier with range of ± 480 Hz. The directional signal is radiated as a cardioid pattern rotating at 30 revolutions per second, which creates a 30 Hz AM signal.</p> <p>The direction signal is arranged to be in phase with the reference signal when the aircraft is due north (magnetic) of the VOR station. As the cardioid pattern rotates around the station, the two signals become out of phase on a progressive basis. The difference in phase angle between the reference and direction signals is displayed to the crew as a radial from the VOR station. The VOR system can also transmit specific bearing information, referred to as a <i>radial</i>, using the Bearing soft key. The pilot can select any radial from a given VOR navigation aid and fly to or from that station. VOR radials are referenced to magnetic north and are the basis of the <i>airways</i> used for navigation.</p> <p>The VOR feature of the avionics test mode is capable of receiving and analyzing the combined reference and direction signal.</p>
--	--

Selcal (AVIONICS submenu)

Opens the Selcal table and submenu.

Saved State	Saved with instrument state
Notes	The SELCAL signal generated is comprised of two consecutive equal tone pulses, with each pulse containing two simultaneously transmitted tones. Each pulse, of 1-second duration, is separated by an interval of about 0.2 seconds. The tones are labeled with letters A through S, excluding I, N, and O

150 Hz (Localizer & Glide Slope submenus)

Opens the 150 Hz dialog where you can set the modulation tone for the 150 Hz ILS signal for the radio under test.

Range	0 Hz to 160 Hz
Default	150 Hz
Saved State	Saved with instrument state

90 Hz (Localizer & Glide Slope submenus)

Opens the 90 Hz dialog where you can set the modulation tone for the 90 Hz ILS signal for the radio under test.

Range	0 Hz to 110 Hz
Default	90 Hz
Saved State	Saved with instrument state

SDM (Localizer & Glide Slope submenus)

Opens the SDM dialog where you can set the sum of depth modulation percentage for the radio under test.

Range	30 % to 50 %
Default	40 %
Saved State	Saved with instrument state

DDM (Localizer & Glide Slope submenus)

Opens the DDM dialog where you can set the differential depth modulation percentage for the radio under test.

Range	70 % to 90 %
Default	80 %
Saved State	Saved with instrument state

DDM Presets (Localizer & Glide Slope submenus)

Opens the DDM Presets dialog where you can set the preset differential depth modulation percentage for the radio under test.

Discrete values	-15.5, -9.3, -4.5, 0, 4.5, 9.3, 15.5
Default	0
Saved State	Saved with instrument state

Flag Test (Localizer & Glide Slope submenus)

Changes the displayed color of the NAV Flag on the main screen and toggles between Red and Green, when the Flag Test input toggles Off and On.

Discrete Values	Off, On
Default	Off
Saved State	Saved with instrument state
Notes	The Flag Test is Off (RED) by default and is used to turn the 150 Hz tone off. This results in the transmission of a pure sinewave of 90 Hz. Turning the 90 Hz tone Off and creating a pure 150 Hz

	<p>sinewave can be accomplished manually by setting the DDM input to -40%. Flag Test turns green to indicate it is now On.</p> <p>Morse code can be overlaid on the following signals: Localizer, Glide Slope, and VOR. It can be turned ON/Off with the Morse code string representing an Airport code changed,</p> <p>A 3–5 digit Morse code signal for the Localizer and VOR is generated with a code tone frequency of 1020 Hz and 60% AM modulation. The code, which can be turned ON/Off, repeats at 0.3 s intervals with a duration of 300 ms. Digits A–Z, 0–9 can also be selected from a pre-populated Morse code table in the sub menu.</p>
--	---

Ident Off/On (All submenus)

Toggles the operating state of the Morse Code IDENT signal.

Discrete Values	Off, On
Default	Off
Saved State	Saved with instrument state

Ident Code (All submenus)

Opens the Ident Code dialog where you can enter the Morse Code Identification for the radio under test.

Discrete Values	A, B, C, D, E, F, G, H, I, J, K, L, M, N, O, P, Q, R, S, T, U, V, W, X, Y, Z,
Default	DFW
Saved State	Saved with instrument state

Localizer Channel (Localizer submenu)

Opens the Localizer Channel dialog where valid Localizer channel frequencies can be selected.

Discrete Values	108.1 MHz, 108.15 MHz, 108.3 MHz, 108.35 MHz, 108.5 MHz, 108.55 MHz, 108.7 MHz, 108.75 MHz, 108.9 MHz, 108.95 MHz, 109.1 MHz, 109.15 MHz, 109.3 MHz, 109.35 MHz, 109.5 MHz, 109.55 MHz, 109.7 MHz, 109.75 MHz, 109.9 MHz, 109.95 MHz, 110.1 MHz, 110.15 MHz, 110.3 MHz, 110.35 MHz, 110.5 MHz, 110.55 MHz, 110.7 MHz, 110.75 MHz, 110.9 MHz, 110.95 MHz, 111.1 MHz, 111.15 MHz, 111.3 MHz, 111.35 MHz, 111.5 MHz, 111.55 MHz, 111.7 MHz, 111.75 MHz, 111.9 MHz, 111.95 MHz
Default	108.1 MHz
Saved State	Saved with instrument state
Notes	For ILS signals, as well as VOR, only valid channel frequencies can be chosen from a predefined list.

Glider Channel (Glide Slope submenu)

Opens the Glider Channel dialog where valid Glider channel frequencies can be selected.

Discrete Values	334.70 MHz, 334.55 MHz, 334.10 MHz, 333.95 MHz, 329.90 MHz, 329.75 MHz, 330.50 MHz, 330.35 MHz, 329.30 MHz, 329.15 MHz, 331.40 MHz, 331.25 MHz, 332.00 MHz, 331.85 MHz, 332.60 MHz, 332.45 MHz, 333.20 MHz, 333.05 MHz, 333.80 MHz, 333.65 MHz, 334.40 MHz, 334.25 MHz, 335.00 MHz, 334.85 MHz, 329.60 MHz, 329.45 MHz, 330.20 MHz, 330.05 MHz, 330.80 MHz, 330.65 MHz, 331.70 MHz, 331.55 MHz, 332.30 MHz, 332.15 MHz, 332.90 MHz, 332.75 MHz, 333.50 MHz, 333.35 MHz, 331.10 MHz, 330.95 MHz
Default	334.70 MHz
Saved State	Saved with instrument state
Notes	For ILS signals, as well as VOR, only valid channel frequencies can be chosen from a predefined list.

VOR Channel (VOR submenu)

Opens the VOR Channel dialog where valid Glider channel frequencies can be selected.

Discrete Values	108.00 MHz, 108.05 MHz, 108.20 MHz, 108.25 MHz, 108.40 MHz, 108.45 MHz, 108.60 MHz, 108.65 MHz, 108.80 MHz, 108.85 MHz, 109.00 MHz, 109.05 MHz, 109.20 MHz, 109.25 MHz, 109.40 MHz, 109.45 MHz, 109.60 MHz, 109.65 MHz, 109.80 MHz, 109.85 MHz, 110.00 MHz, 110.05 MHz, 110.20 MHz, 110.25 MHz, 110.40 MHz, 110.45 MHz, 110.60 MHz, 110.65 MHz, 110.80 MHz, 110.85 MHz, 111.00 MHz, 111.05 MHz, 111.20 MHz, 111.25 MHz, 111.40 MHz, 111.45 MHz, 111.60 MHz, 111.65 MHz, 111.80 MHz, 111.85 MHz, 112.00 MHz, 112.05 MHz, 112.10 MHz, 112.15 MHz, 112.20 MHz, 112.25 MHz, 112.30 MHz, 112.35 MHz, 112.40 MHz, 112.45 MHz, 112.50 MHz, 112.55 MHz, 112.60 MHz, 112.65 MHz, 112.70 MHz, 112.75 MHz, 112.80 MHz, 112.85 MHz, 112.90 MHz, 112.95 MHz, 113.00 MHz, 113.05 MHz, 113.10 MHz, 113.15 MHz, 113.20 MHz, 113.25 MHz, 113.30 MHz, 113.35 MHz, 113.40 MHz, 113.45 MHz, 113.50 MHz, 113.55 MHz, 113.60 MHz, 113.65 MHz, 113.70 MHz, 113.75 MHz, 113.80 MHz, 113.85 MHz, 113.90 MHz, 113.95 MHz, 114.00 MHz, 114.05 MHz, 114.05 MHz, 114.10 MHz, 114.15 MHz, 114.20 MHz, 114.25 MHz, 114.30 MHz, 114.35 MHz, 114.40 MHz, 114.45 MHz, 114.50 MHz, 114.55 MHz, 114.60 MHz, 114.65 MHz, 114.70 MHz, 114.75 MHz, 114.80 MHz, 114.85 MHz, 114.90 MHz, 114.95 MHz, 115.00 MHz, 115.05 MHz, 115.10 MHz, 115.15 MHz, 115.20 MHz, 115.25 MHz, 115.30 MHz, 115.35 MHz, 115.40 MHz, 115.45 MHz, 115.50 MHz, 115.55 MHz, 115.60 MHz, 115.65 MHz, 115.70 MHz, 115.75 MHz, 115.80 MHz, 115.85 MHz, 115.90 MHz, 115.95 MHz, 116.00 MHz, 116.05 MHz, 116.10 MHz, 116.15 MHz, 116.20 MHz, 116.25 MHz, 116.30 MHz, 116.35 MHz, 116.40 MHz, 116.45 MHz, 116.50 MHz, 116.55 MHz, 116.60 MHz, 116.65 MHz, 116.70 MHz, 116.75 MHz, 116.80 MHz, 116.85 MHz, 116.90 MHz, 116.95 MHz, 117.00 MHz, 117.10 MHz, 117.15 MHz, 117.20 MHz, 117.25 MHz, 117.30 MHz, 117.35 MHz, 117.40 MHz, 117.45 MHz, 117.50 MHz, 117.55 MHz, 117.60 MHz, 117.65 MHz, 117.70 MHz, 117.75 MHz, 117.80 MHz, 117.85 MHz, 117.90 MHz, 117.95 MHz
Default	108.00 MHz
Saved State	Saved with instrument state
Notes	Only valid channel frequencies can be chosen from a predefined list.

RF Level (All submenus)

Opens the RF Level dialog where you can input the RF output power.

Range	-130 to -30 dBm
Default	-40 dBm
Saved State	Saved with instrument state

Gen Port (All submenus)

Opens the Gen Port dialog where you can choose the transmitter output.

Discrete Values	RF In/Out, RF Gen Out
Default	RF In/Out
Saved State	Saved with instrument state

Frequency (Markers submenu)

Opens the Frequency dialog where you can choose the Marker Beacon signal frequency.

Range	250 kHz to 1 GHz
Default	75 MHz
Saved State	Saved with instrument state

Outer Marker (Markers submenu)

Modulates the RF carrier with a 400 Hz tone.

Middle Marker (Markers submenu)

Modulates the RF carrier with a 1300 Hz tone.

Inner Marker (Markers submenu)

Modulates the RF carrier with a 3000 Hz tone.

AM Modulation Depth (Markers submenu)

Opens the AM Modulation dialog where you can set the AM modulation depth for the beacon.

Range	0 % to 100 %
Default	95 %
Saved State	Saved with instrument state

AM Depth Set Adjust (NDB/ADF submenu)

Opens the AM Depth Set Adjust dialog where you can set the AM Depth for the NDB signal.

Range	0 % to 100 %
Default	35 %
Saved State	Saved with instrument state

Modulation Tone (NDB/ADF submenu)

Transmits an amplitude modulated by a Morse code string.

Saved State	Saved with instrument state
Notes	The NDB/ADF signal can be repeated indefinitely when the Repeat Cycle flag is True.

Repeat Cycle (NDB/ADF submenu)

Opens the Repeat Cycle dialog where you can enable or disable repeating NDB/ADF signaling.

Discrete Values	Off, On
Default	Off
Saved State	Saved with instrument state
Notes	When the Repeat Cycle flag is False, a single transmission of the user-specified Morse code is performed.

Bearing (VOR submenu)

Opens the Bearing dialog where you can adjust bearing by the selected increment.

Range	0 to 360 Deg
Default	0 Deg
Saved State	Saved with instrument state

Ref AM Depth (VOR submenu)

Opens the Ref AM Depth dialog where you can adjust the 30 Hz reference AM depth.

Range	20% to 30 %
Default	30 %
Saved State	Saved with instrument state

Reference Depth (VOR submenu)

Adjust and enter 9.960 Hz AM depth.

Range	20 % to 30 %
Default	30 %
Saved State	Saved with instrument state

Sub Frequency (VOR submenu)

Opens the Sub Frequency dialog where you can set the 9.960 Hz carrier frequency.

Range	9960 Hz \pm 10%
Default	9960 Hz
Saved State	Saved with instrument state

Ref Deviation (VOR submenu)

Opens the Ref Deviation dialog where you can set the reference deviation.

Range	0 Hz to 500 Hz
Default	480 Hz
Saved State	Saved with instrument state

To/From (VOR submenu)

Select To/From and update directional flag.

Discrete Values	To, From
Default	To
Saved State	Saved with instrument state

Variable On/Off (VOR submenu)

Suppress variable signal component.

Discrete Values	On, Off
Default	On
Saved State	Saved with instrument state

Reference On/Off (VOR submenu)

Suppress reference signal component.

Discrete Values	On, Off
Default	On
Saved State	Saved with instrument state

Var Frequency (VOR submenu)

Opens the Var Frequency dialog where you can adjust the 30 Hz reference frequency.

Range	20 Hz to 40 Hz
Default	30 Hz
Saved State	Saved with instrument state

Slow/Fast (VOR submenu)

Controls the Slew Bearing in 1 degree increments.

Discrete Values	Slow, Fast
Default	Slow
Saved State	Saved with instrument state

Bearing Slew Rate (VOR submenu)

Slew bearing in 1 degree increments, 30 sec duration for 360 degrees.

Discrete Values	Slow, Fast
Default	Slow
Saved State	Saved with instrument state

Selcal Code (Selcal submenu)

Opens the Selcal Code dialog where you can enter a 4-letter Selective Calling System number identifying the aircraft.

Discrete Values	A, B, C, D, E, F, G, H, J, K, L, M, P, Q, R, S
Default	ABCD
Saved State	Saved with instrument state
Notes	<p>The SELCAL signal generated is comprised of two consecutive equal tone pulses, with each pulse containing two simultaneously transmitted tones. Each pulse, of 1-second duration, is separated by an interval of about 0.2 seconds. The tones are labeled with letters A through S, excluding I, N, and O.</p> <p>In order to generate a valid sequence pair, you must select four letters (2 sets of two letters), such as AB-CD with the following three tone restrictions:</p> <ol style="list-style-type: none"> 1. A given letter can be used only once. 2. Letters cannot be not repeated, for example: <ul style="list-style-type: none"> ◦ AB-CD is a valid entry ◦ AA-BC and AB-BC are not valid selections

	<p>3. Letters in a pair must be entered in alphabetical order, for example:</p> <ul style="list-style-type: none"> ◦ AB-CD and CD-AB are valid entries ◦ CD-BA is not a valid entry <p>For an invalid SELCAL code entry, only a carrier is transmitted. No SELCAL signal is transmitted in this scenario.</p>
--	---

AM Depth (Selcal submenu)

Opens the AM Depth dialog where you can enter depth of the Selcal amplitude modulation in percent.

Range	0 % to 40 %
Default	30 %
Saved State	Saved with instrument state

AutoTune Soft Keys

AutoTune is an optional automated test and alignment software application for manufacturer-specific radios embedded in the R8200, eliminating need for an external computer, simplifying setup and equipment costs for this function. A connection between an R8200 USB port and the radio under test controls the radio.

Operator ID (AutoTune submenu)

Displays a dialog where you can enter the Operator ID.

Range	A-Z and 0-9
Saved State	Saved with instrument state
Notes	By default, an Operator ID is required to begin testing (Start soft key appears after entry is made). This can be changed in the Preferences selection under the Tools menu.

Radio Make & Model (AutoTune submenu)

Displays a dialog where you can select the model radio to test.

Discrete Values	Motorola: XTL1500, XTL2500, XTL2500 High, XTL5000, XTL5000 High, XTS1500, XTS2500, XTS5000, APX1000, APX1500, APX2000, APX2500, APX4000, APX4500, APX6000, APX 6500, APX6500 High, APX7000, APX7500, APX7500 High, SRX2200, APX8000, APX8500, APX8500 High TRBO Mobile, TRBO Portable Kenwood: Kenwood: NX Mobile, NX Portable, NX 3K5K Mobile, NX 3K5K Portable, Viking Mobile, Viking Portable Harris: XG-75 Mobile, XG-75 Portable, XG-100 Mobile, XL Portable BKReIm: KNG-P150, KNG-P400, KNG-P500, KNG-P800, KNG S-Series
-----------------	---

	Hytera: DMR Mobile, DMR Portable Technisonic: TDFM-9X00
Default	No Selection
Saved State	Saved with instrument state
Notes	By default, an Operator ID is required to begin testing (Start soft key appears after entry is made). This can be changed in the Preferences selection under the Tools submenu.

Activity (AutoTune submenu)

Displays a dialog where you can select the desired verification activity.

Discrete Values	Test Only, Test & Align
Default	Test Only
Saved State	Saved with instrument state
Notes	<p>Test Only – Measures and compares the radio’s performance against the manufacturer’s test limits without alignment; then it indicates Pass/Fail in the Results column and displays detailed data in a test report.</p> <p>Test & Align – Performs a radio alignment, tests to the manufacturer’s limits, and then provides Pass/Fail results and a test report.</p>

Toggle Test Selection (AutoTune submenu)

Enables or disables the script highlighted by the marker (blue triangle) for AutoScript execution or procedure creation.

Select All (AutoTune submenu)

Selects all test types listed in the Test column.

Clear All (AutoTune submenu)

Clears all test selections.

Tools (AutoTune submenu)

Provides horizontal soft keys menu to access test limits, test reports, and set AutoTune operational preferences.

Discrete Values	Test Limits, Test Report, Preferences
Saved State	Saved with instrument state
Notes	<p>Test Limits – Displays a screen and submenu for pass/fail limits of the selected radio make used to edit test limits for the manufacturer-specific radio under test. Each test type can be selected by positioning the blue indicating arrow with the vertical arrow keys or tuning knob.</p> <p>Edit Test Limit – Activates a data entry window where you can adjust the numeric value using the arrow keys, numeric keypad, and tuning knob.</p> <p>Test Report – Displays a screen and submenu of test logs used to view or delete the current or a previous test log, which contains a report for each test performed in a test session. Test logs are saved in *.csv format to allow exporting to a spreadsheet or other data manipulation program. Individual test logs and test reports can be imported from or exported to a flash memory drive attached to one of the USB ports on the R8200.</p> <p>Preferences – Displays a screen and submenu used to enable or disable automatic settings for Operator ID, Display Report, Unique Log Files, and Display Setup Diagrams.</p>

Log Out Operator (AutoTune submenu)

Clears the Operator ID field when the operator is finished, ensure that the following test logs and reports are assigned to the following operator.

Load Default Test Limit Values (Test Limits submenu)

Resets all test limits for the currently-selected radio model to their factory default values.

Edit Test Limit (Test Limits submenu)

Activates a data entry window to adjust the numeric test limit value.

Save Changes (Test Limits submenu)

Stores the edited limits for use by all future activities.

Cancel Changes (Test Limits submenu)

Cancels the edited limits and exits the Test Limits editor.

Return (Test Limits submenu)

Returns to the main AutoTune menu.

Select Test Log to Open (Test Reports submenu)

Opens a previously saved Test Log that contains the test reports from a previous test session.

Select Test Report to Open (Test Reports submenu)

Opens an individual Test Report from within the current Test Log or a previously loaded one.

Export Test Report (Test Reports submenu)

Copies an individual Test Report from within the current Test Log to a USB drive.

Export All Test Report (Test Reports submenu)

Copies all Test Reports from within the current Test Log to a USB drive.

Export Test Log (Test Reports submenu)

Copies a previously saved Test Log that contains the test reports to a USB drive.

Export All Test Logs (Test Reports submenu)

Copies all previously saved Test Logs that contain the test reports to a USB drive.

Delete Test Log (Test Reports submenu)

Erases the current Test Log.

Return (Test Reports submenu)

Returns to the Main AutoTune menu.

Require Operator ID (Test Preferences submenu)

AutoTune requires the Operator ID to be set before testing can be initiated because it is logged in the test data and reported in the formatted test report.

Discrete Values	Yes, No
Default	Yes
Saved State	Saved with instrument state
Notes	If the field is blank, the operator is not recorded. Setting this preference to No will allow testing to be started without an Operator ID.

Display Report (Test Preferences submenu)

AutoTune will automatically display this screen at the completion of all tests.

Discrete Values	Yes, No
Default	Yes
Saved State	Saved with instrument state
Notes	AutoTune stores the results from each test in a comma-delimited log file. These results can be viewed at any time by pressing Test Reports on the AutoTune screen. Test Reports displays the logged test results in an easy to read format.

Unique Log Files (Test Preferences submenu)

Test log data is recorded and saved to a comma-delimited format filename based on the serial number of the radio under test (e.g., XTS5000_11124.csv).

Discrete Values	Yes, No
Default	Yes
Saved State	Saved with instrument state
Notes	Setting this preference to No will cause all test log data to be saved under a common log file name based on the radio make and model (e.g., XTS5000.csv). Recommended: Set to No if testing and reporting a batch of radios.

Display Setup Diagrams (Test Preferences submenu)

This setting controls the display of Test Setup Diagrams at the start of testing.

CAUTION

If the radio under test requires the test setup to be changed during testing, this option will be ignored. In this situation, it is critical that the user review the diagrams to ensure that the cable setup is correct. Incorrect setup will result in false test failures and possibly damage the radio or analyzer.

Discrete Values	Yes, No
Default	Yes
Saved State	Saved with instrument state
Notes	When No, the diagrams will not be shown. Recommended: Yes

Save Preferences (Test Preferences submenu)

This selection stores the edited preferences for use by all future activities.

RF Level Offset (Test Preferences submenu)

When enabled, the R8200 applies the RF offset in the RF In/Out field next to it to the output levels and input power measurements used by AutoTune.

Discrete Values	Off, On
Default	Off
Saved State	Saved with instrument state
Notes	When disabled (default), the value in the RF In/Out field is ignored. This field mirrors the RF Level Offset field described in System Settings. Recommended: Yes

RF In/Out Offset (Test Preferences submenu)

This field specifies the gain or loss between the RF In/Out port and the unit under test.

Range	-99.0 to 99 dB
Default	0.0
Saved State	Saved with instrument state
Notes	<p>In the case of a loss, such as a cable or attenuator, enter a negative value. The affected field values will be increased to compensate. In Generate Mode, for example, if a -6.0 dB value is entered, the Output Level amplitude is increased by 6 dB. In Monitor Mode, for example, the input level is increased by 6 dB. In the case of a gain, such as an amplifier, enter a positive value. The affected fields will be decreased to compensate. In Generate Mode, for example, if a 10.0 dB value is entered, the Output Level amplitude will decrease by 10 dB. In Monitor Mode, for example, Wattmeter measurements will be reduced by 10 dB.</p> <p>This value is not used if RF Level Offset is disabled (Off). This field mirrors the RF In/Out field described in System Settings.</p> <p>Recommended: Yes</p>

Cable Sweep Enable (Test Preferences submenu)

When enabled, the R8200 applies the frequency response data stored in the cable sweep file to the output levels and input power measurements used by AutoTune.

Discrete Values	Off, On
Default	Off
Saved State	Saved with instrument state

Cable Sweep File (Test Preferences submenu)

Displays the Cable Sweep File dialog where you can select a cable sweep file associated with the test setup cable when compensating for the output levels and input power measurements used by AutoTune.

Return (Test Preferences submenu)

Exits the Test Preferences submenu and returns to the AutoTune Main menu.

AutoScript Soft Keys

AutoScript provides monitor and control (M&C) script execution from within the R8200. Using this feature, repetitive measurements normally requiring several keystrokes can be programmed into plain text scripts and the results written to an exportable log file. Scripts are imported into the R8200 using a USB drive and may be combined together to form procedures. Procedures can be saved and recalled to run a particular set of scripts.

View (AutoScript submenu)

Activates a horizontal soft key menu where you can toggle between the Scripts and Results menus.

Discrete Values	Scripts, Results
Default	Scripts
Saved State	Saved with instrument state

Toggle Selection

Enables or disables script selected by the selection marker (blue triangle) for AutoScript execution or procedure creation.

Saved State	Saved with instrument state
Notes	Move the selection marker with the tuning knob or arrow keys. If Start AutoScript or Save as Procedure soft keys are selected, only enabled scripts are utilized.

Start AutoScript

Begins execution of enabled scripts in the script list.

Saved State	Saved with instrument state
Notes	<p>During execution, front panel button selections are ignored until AutoScript completes. An exception to this behavior is if an AutoScript prompt appears. In this case, soft keys are active to allow user input.</p> <p>Visible only when at least one script is enabled with Toggle Selection.</p>

Move Up

Shifts script at selection marker up one row in script list while any script in row above selected script is shifted down into selected script's old row.

Move Down

Shifts script at selection marker down one row in script list while any script in row below selected script is shifted up into selected script's old row.

Copy Script

Duplicates the script at the selection marker into the next row so that it can be run more than once.

Saved State	Saved with instrument state
Notes	<p>It may be moved up or down afterwards. The copy is only a reference to the script file and will not be retained if the R8200 Power is turned off. However, the duplication may be retained with Save as Procedure.</p> <p>Visible only when a script exists on the unit's hard drive.</p>

Save As Procedure

Creates a newly-named procedure from enabled scripts in the script list.

Saved State	Saved with instrument state
Notes	Once created, the procedure is available for selection using the Load Procedure soft key. Visible only when a script exists on the unit's hard drive.

Refresh Scripts

Refreshes script list with currently available scripts imported to the unit's hard drive.

Saved State	Saved with instrument state
Notes	If a procedure was loaded before selecting this soft key, its scripts are replaced with the list of scripts currently available for execution on the unit. Visible only when a script exists on the unit's hard drive.

Export Procedure

Exports one or more procedures from the unit's hard drive to a USB drive.

Saved State	Saved with instrument state
Notes	When selected, a list of procedures available for export is provided. Visible only when a USB drive is inserted into the unit and at least one procedure is available for export.

Step Delay (AutoScript submenu)

Controls the delay between each script step or line in the script during script execution.

Range	0 to 60 s
Default	0 s
Saved State	Saved with instrument state

Script Delay (AutoScript submenu)

Controls the delay between each script selected for execution.

Range	0 to 60 s
Default	0 s
Saved State	Saved with instrument state

Record Result (AutoScript submenu)

Controls whether to send execution results to a file.

Discrete Values	Off, On
Default	Off
Saved State	Saved with instrument state

Import Scripts

Import scripts from a USB drive to the unit's hard drive.

Saved State	Saved with instrument state
Notes	When selected, it provides a list of scripts available for import. Visible only when a USB drive containing scripts in the correct subfolder (<USB_Drive>:\FREEDOM\AutoScript) is inserted into the unit.

Delete Scripts

Deletes the selected script from the unit's hard drive and removes all references to it from the script list.

Saved State	Saved with instrument state
Notes	After being deleted, that script must be imported again to use it in AutoScript. Visible only when a script exists on the unit's hard drive.

Delete Procedure

Deletes the selected procedure from the unit's hard drive.

Saved State	Saved with instrument state
Notes	After being deleted, that procedure must be either imported again or recreated from available scripts on the unit's hard drive to be used in AutoScript. Visible only when a script exists on the unit's hard drive.

13 Settings Mode Soft Keys

The Settings menu is divided into six functional submenus concerned with global system settings, battery status, network setup for remote operation, messaging, versioning, and instrument options. This chapter contains detailed descriptions of the soft keys accessible in each. Each soft key is defined, along with its range, discrete, default, and saved state values.

"Settings Mode Soft Keys" on the next page enables access to R8200 battery status, message acknowledgement, hardware and software versioning, software updating, and instrument options.

"System Settings Soft Keys" on the next page enables configurable parameters for Cable Sweep, Measurement Averaging and Offsets, Attenuation, Pre-amplification, Pre-emphasis/De-emphasis, Metering Filters, Internal Audio Weighting, Global Language, Date, and Time, and default value restoration.

"Network Setup Soft Keys" on page 820 enables configurable parameters for connecting the R8200 to a network.

Settings Mode Soft Keys

The Settings Mode menu enables the display and configuration of battery status, message acknowledgment, hardware and software versioning, software updating, and instrument options.

System Settings (Settings submenu)

Activates submenus for system-wide settings.

System Settings Soft Keys

These soft keys enable the display and configuration of Cable Sweep, Measurement Averaging and Offsets, Attenuation, Pre-amplification, Pre-emphasis/De-emphasis, Metering Filters, Internal Audio Weighting, Global Language, Date, and Time, and default value restoration.

Cable Sweep Table (System Settings submenu)

Activates the Cable Sweep Table and submenu.

Notes	The Cable Sweep function provides an easy way for the user to determine the loss characteristics of a test cable across frequency and store that information within the R8200 with a user-defined name. Up to fifty cable files can be stored.
-------	--

Enable (Cable Sweep Table submenu)

Displays a dialog where you can enable or disable cable sweeps.

Discrete Values	Off, On
Default	Off

Saved State	Saved with instrument state
Notes	When activated, the R8200 compensates for the return loss of the currently selected cable during the measurement sweep.

New Two Points (Cable Sweep Table submenu)

Opens a vertical soft key menu where you can enter cable loss values at 100 MHz and 1 GHz for a new cable.

Return to Table (New Two Points submenu)

Closes the Two Points entry menu without saving.

100 MHz Loss (New Two Points submenu)

Displays a dialog where you can enter a cable loss value associated with 100 MHz.

Range	-99 to 0 dB
Default	0 dB
Saved State	Saved with instrument state

1 GHz Loss (New Two Points submenu)

Displays a dialog where you can enter a cable loss value associated with 1 GHz.

Range	-99 to 0 dB
Default	0 dB
Saved State	Saved with instrument state

Save File As (New Two Points submenu)

Saves the entered cable properties for later use.

Discrete Values	A to Z, 0 to 9, and . (period symbol)
Saved State	Saved with instrument state
Notes	The name can be 16 characters long. It may contain uppercase text/numbers and some symbols.

New Multiple Points (Cable Sweep Table submenu)

Utilizes the Tracking Generator (R8-TG) to create a multi-point loss data measurement for use in cable sweeps.

Continue (New Multiple Points submenu)

Performs the cable measurement and continues to the next menu.

Notes	First used to measure the reference cable, then used to measure the cable loss.
-------	---

Save File As (New Multiple Points submenu)

Saves the multi-point cable sweep for later use.

Notes	The name can be 16 characters long. It may contain uppercase text/numbers and some symbols. After the data is saved the screen will return to the Cable Sweep Table and you will be able to review the frequency response of the cable.
-------	--

Edit (Cable Sweep Table submenu)

Displays a dialog where you can edit the name of the selected cable loss file.

Delete (Cable Sweep Table submenu)

Deletes the selected cable loss file.

Delete All Files (Cable Sweep Table submenu)

Deletes every cable loss file in the table.

Export (Cable Sweep Table submenu)

Exports a table of cable sweep files.

Saved State	Saved with instrument state
Notes	A USB drive must be plugged into the R8200 to see the Export or Import selections.

Import (Cable Sweep Table submenu)

Imports a table of cable sweep files.

Saved State	Saved with instrument state
Notes	A USB drive must be plugged into the R8200 to see the Export or Import selections.

Input Impedance (Cable Sweep Table submenu)

Selects the input impedance for the Meter In port.

Discrete Values	600 Ω , 1 M Ω
Default	1 M Ω
Saved State	Saved with instrument state
Notes	To prevent damage to the R8200, the 600 Ω input impedance is restricted to AC and DC ranges of 10 Volts or less. Both the AC and DC voltmeters must be set to a range of 10 Volts or less before 600 Ω can be selected.

Input Decoding (System Settings submenu)

Displays a dialog where you can switch between Internal and External decoding, the signal source used for the R8200 frequency counter and decode functions.

Discrete Values	Internal, External
Default	Internal
Saved State	Saved with instrument state
Notes	When set to Internal, the recovered audio or tones from a demodulated received signal are used as the signal source. The External setting directs an externally-applied signal at the Meter In port to the R8200 frequency counter and decode circuits.

Reference Clock Mode (System Settings submenu)

Selects the mode for the 10 MHz Ref In/Out connector on the R8200 side panel.

Discrete	Output, Input
----------	---------------

Values	
Default	Output
Saved State	Saved with instrument state
Notes	<p>Output – Routes the internal 10 MHz time base signal to the 10 MHz Ref In/Out connector for use as a frequency reference by external equipment.</p> <p>Input – Allows an external time base signal (5 MHz or 10 MHz) applied to the 10 MHz Ref In/Out connector to be routed into the R8200.</p>

Analog Measurement Averaging (System Settings submenu)

Displays a dialog where you can enable or disable measurement averaging to smooth a number of analog readings.

Discrete Values	Off, On
Default	Off
Saved State	Saved with instrument state
Notes	<p>Analog Measurement Averaging affects the following:</p> <p>RF Zone – Frequency Error, Deviation</p> <p>DISPLAY Zone – Frequency Error Bar Graphs, Deviation Bar Graphs</p> <p>METER Zone – AC Volts, DC Volts, Internal Distortion, External Distortion, SINAD</p>

Analog Averaging Samples (System Settings submenu)

Displays a dialog where you can adjust the number of analog averaging samples used in measurement averaging.

Range	2 to 100
Default	7
Saved State	Saved with instrument state

Digital Measurement Averaging (System Settings submenu)

Displays a dialog where you can enable or disable measurement averaging to smooth a number of digital readings.

Discrete Values	Off, On
Default	Off
Saved State	Saved with instrument state
Notes	<p>Digital Measurement Averaging affects the following:</p> <p>DMR Zone – Symbol Deviation, FSK Error; Magnitude Error</p> <p>PROJECT 25 Zone – Symbol Deviation, Modulation Fidelity</p> <p>P25 Trunk Zone – Symbol Deviation, Modulation Fidelity</p> <p>NXDN™ Zone – Symbol Deviation, Modulation Fidelity</p> <p>TETRA Zone – Averaging is controlled locally</p>

Digital Averaging Samples (System Settings submenu)

Displays a dialog where you can adjust the number of Digital Averaging Samples used in measurement averaging.

Range	2 to 100
Default	7
Saved State	Saved with instrument state

Automatic Attenuation (System Settings submenu)

Displays a dialog where you can enable or disable Automatic Attenuation.

Discrete Values	Off, On
Default	On
Saved State	Saved with instrument state

Auto Attn Minimum (System Settings submenu)

Displays a dialog where you can set the Auto Attn Minimum value.

Discrete Values	0, 2, 4, 6, 8, 10, 12, 14, 16, 18, 20, 22, 24, 26, 28, 30, 32, 34 dB
Default	0 dB
Saved State	Saved with instrument state

Auto Attn High Threshold (System Settings submenu)

Displays a dialog where you can set the Auto Attenuation high threshold value.

Range	-19 to 0 dB
Default	-10 dB
Saved State	Saved with instrument state

Auto Attn Low Threshold (System Settings submenu)

Displays a dialog where you can set the Auto Attenuation low threshold value.

Range	-40 to -21 dB
Default	-30 dB
Saved State	Saved with instrument state

Pre-Amplifier Auto Off (System Settings submenu)

Displays a dialog where you can enable or disable the Pre-Amplifier Auto Off.

Discrete Values	Disabled, Enabled
Default	Enabled
Saved State	Saved with instrument state
Notes	When enabled (default), the R8200 automatically switches off the Pre-Amplifier to maintain measurement accuracy when broadband RF power measurements are selected or detected. A message appears for several seconds acknowledging that the Pre-Amplifier will be turned off. If you choose to override the setting, an alert is displayed.

RF Level Offset (System Settings submenu)

Displays a dialog where you can enable or disable RF Level Offset.

Discrete Values	Off, On
Default	Off
Saved State	Saved with instrument state
Notes	<p>When enabled, the R8200 applies the RF offsets to various TX signals and RX measurements and displays this below the RF In/Out, RF Gen Out, and Antenna fields. When disabled (default), the values in the RF In/Out, RF Gen Out, and Antenna fields are ignored.</p> <p>Affected fields include:</p> <ul style="list-style-type: none">Output LevelTracking Generator Output LevelInput LevelPower Meter/WattmeterSpectrum analyzer trace, in DISPLAY Zone and Spectrum Analyzer and Dual Display in Instrument ModeTracking Generator traceDMR and TETRA Power Profile traceTETRA unwanted powerAutoTune output and input levels

RF In/Out Offset (System Settings submenu)

Displays a dialog where you can specify the gains or losses between the RF In/Out port and the unit under test.

Range	-99 to 99 dB
Default	0 dB
Saved State	Saved with instrument state
Notes	<p>In the case of a loss, such as a cable or attenuator, enter a negative value. The affected field values will be increased to compensate. In Generate Mode, for example, if a -6.0 dB value is entered, the Output Level amplitude is increased by 6 dB. In Monitor Mode, for example, the Spectrum Analyzer trace is increased by 6 dB.</p> <p>In the case of a gain, such as an amplifier, enter a positive value. The affected fields will be decreased to compensate. In Generate Mode, for example, if a 10.0 dB value is entered, the Output Level amplitude will decrease by 10 dB. In Monitor Mode, for example, Watt Meter measurements will be reduced by 10 dB.</p> <p>This value is not used if RF Level Offset is disabled (Off).</p>

RF Gen Out Offset (System Settings submenu)

Displays a dialog where you set the RF Gen Out Offset value specifying the gains or losses between the RF Gen Out port and the unit under test.

Range	-99 to 99 dB
Default	0 dB
Saved State	Saved with instrument state
Notes	In the case of a loss, such as a cable or attenuator, enter a negative value. The affected field val-

	<p>ues will be increased to compensate. For example, if a –6.0 dB value is entered, the Output Level amplitude is increased by 6 dB.</p> <p>In the case of a gain, such as an amplifier, enter a positive value. The affected fields will be decreased to compensate. For example, if a 10.0 dB value is entered, the Output Level amplitude will decrease by 10 dB.</p> <p>This value is not used if RF Level Offset is disabled (Off).</p>
--	--

Cable Sweep Enable (System Settings submenu)

Displays a dialog where you can enable or disable cable sweep information.

Discrete Values	Off, On
Default	Off
Saved State	Saved with instrument state

Cable Sweep File (System Settings submenu)

Displays a dialog where you can select a Cable Sweep File for use in measurements.

Antenna Offset (System Settings submenu)

Displays a dialog where you can specify the gains or losses between the Antenna port and the unit under test.

Range	–99 to 99 dB
Default	0 dB

Saved State	Saved with instrument state
Notes	<p>In the case of a loss, such as a cable or attenuator, enter a negative value. The affected field values will be increased to compensate. For example, if a -6.0 dB value is entered, the Spectrum Analyzer trace is increased by 6 dB.</p> <p>In the case of a gain, such as an amplifier, enter a positive value. The affected fields will be decreased to compensate. For example, if a 10.0 dB value is entered, the Spectrum Analyzer trace will be reduced by 10 dB.</p> <p>This value is not used if RF Level Offset is disabled (Off).</p>

Mod Out Range (System Settings submenu)

Displays a dialog where you can set the Mod Out Range value (for RF boards version later than 8) between High or ± 8 V (the legacy resolution) and Low ± 0.7472 V.

Discrete Values	High, Low
Default	High
Saved State	Saved with instrument state

Mod Out DC Offset (System Settings submenu)

Displays a dialog where you can set the Mod Out DC Offset value.

Range	-300 to 300 mV
Default	0 mV
Saved State	Saved with instrument state

Pre/De-emphasis (System Settings submenu)

Displays a dialog where you can enable or disable Pre/De-emphasis, the emphasis network for internally-coupled audio signals.

Discrete Values	Off, On
Default	Off
Saved State	Saved with instrument state
Notes	When enabled, the R8200 applies pre-emphasis to audio signals before they modulate the RF carrier and de-emphasis to audio signals demodulated from the RF carrier.

Meter In Filter (System Settings submenu)

Displays a dialog where you can select various filters to apply to external audio signals measured at the Meter In port.

Discrete Values	None, C-Msg, CCITT, De-emphasis
Default	None
Saved State	Saved with instrument state
Notes	None – No filtering is applied to signal. C-Msg – Applies a C-Message weighting filter to signal. CCITT – Applies a ITU-T 0.41 weighting filter to signal. De-emphasis – Applies de-emphasis filter to signal.

Internal Audio Weighting (System Settings submenu)

Displays a dialog where you can select various filters to apply to internal demodulated audio signals.

Discrete Values	None, C-Msg, CCITT
Default	None
Saved State	Saved with instrument state
Notes	None – No filtering is applied to signal. C-Msg – Applies a C-Message weighting filter to signal. CCITT – Applies a ITU-T 0.41 weighting filter to signal.

Language (System Settings submenu)

Activates a horizontal soft key menu where you can select the service monitor's display language.

Discrete Values	English, Spanish
Default	English
Saved State	Saved with instrument state

Date (System Settings submenu)

Displays a dialog where you can set the R8200's date in month, day, year (MM.DD.YYYY) notation.

Notes	Date/Time settings are not applied until Apply Date/Time Changes is pressed.
-------	---

Time (System Settings submenu)

Displays a dialog where you can set the R8200 system clock in 24-hour notation.

Notes	Date/Time settings are not applied until Apply Date/Time Changes is pressed.
-------	---

Apply Date/Time Changes (System Settings submenu)

Saves the entered date/time changes to the R8200 system clock.

Reset to Defaults (System Settings submenu)

Resets all R8200 system settings to the factory defaults.

Battery Status (Settings submenu)

The Battery Status menu displays the current serial number, battery life, and cycle count if a battery is installed.

Network Setup Soft Keys

The soft keys enable connecting the R8200 to a network.

Network Setup (Settings submenu)

Opens a vertical soft key menu where you can configure the R8200 for remote operation.

Network Connection (Network Setup submenu)

Displays a dialog where you can enable or disable the Network Connection.

Discrete Values	Disable, Enable
-----------------	-----------------

Default	Disable
Saved State	Saved with instrument state
Notes	When the network connection is enabled, the R8200 may be controlled by the other computers on the network without restriction. It is strongly recommended that the R8200 be protected from unauthorized access through the use of external security measures.

DHCP (Network Setup submenu)

Displays a dialog where you can enable or disable DHCP (or Dynamic Host Configuration Protocol) by which an IP address is assigned to the R8200 during boot by a DHCP server on the Local Area Network.

Discrete Values	Off, On
Default	On
Saved State	Saved with instrument state
Notes	<p>When the R8200 boots, it puts out a request on the Local Area Network for a DHCP server to assign it an IP address. The DHCP server has a pool (or scope) of IP addresses available. The server responds to this request with an IP address from the pool, along with a lease time. Once the lease time for a given IP address lease has expired, the client must contact the server again and repeat the negotiation. If DHCP is set to off, then a static IP address must be entered for network control.</p> <p>When DHCP is on, the fields for IP Address, Subnet Mask, and Default Gateway are populated with their respective values from the DHCP server.</p>

IP Address (Network Setup submenu)

Applies the user-defined IP address to the R8200.

Subnet Mask (Network Setup submenu)

Displays a dialog where you can set the Communications System Analyzer Subnet Mask.

Use this key to enter the subnet mask address assigned to the R8200 by the network administrator.

Range	000.000.000.000 to 255.255.255.255
Default	000.000.000.000
Saved State	Saved with instrument state

Default Gateway (Network Setup submenu)

Displays a dialog where you can set the Communications System Analyzer Default Gateway.

Use this key to enter the Default Gateway address assigned to the R8200 by the network administrator.

Range	000.000.000.000 to 255.255.255.255
Default	000.000.000.000
Saved State	Saved with instrument state
Notes	This is the address of the router that passes data outside the subnet to which the R8200 is attached.

Acknowledge Message (Settings submenu)

The Acknowledge Message soft key is used to acknowledge and clear messages that appear at the bottom of the R8200 screen.

Notes	Use the tuning knob or arrow keys to select a message.
-------	--

About (Settings submenu)

The About menu is used to view the R8200 software and driver versions.

Notes	<p>This information is important when interacting with Freedom Communication Technologies personnel to resolve technical issues or determine if a firmware upgrade is required.</p> <p>The system version uniquely identifies the combination of subsystem Versions and Protocols shown by their respective soft keys.</p>
-------	--

Protocols (About submenu)

Displays a menu listing all installed optional communication protocols and their associated versions.

Versions (About submenu)

Displays the R8200's hardware, library, and firmware versions.

Main (Protocol & Versions submenus)

Returns to the Main About menu listing basic system info and contact information.

Search for Updates (About submenu)

Searches external USB storage devices for software updates.

Notes	<p>The R8200 firmware can be upgraded in the field using a USB thumb drive.</p> <p>CAUTION Firmware changes can significantly affect analyzer operation and should be performed carefully. An improperly executed firmware upgrade can render the analyzer inoperable. It is recommended that Freedom Communication Technologies support personnel be consulted and involved in firmware upgrades of the R8200.</p> <hr/> <p>Pressing the Search for Updates soft key initiates a search for firmware updates on a USB Flash</p>
-------	---

	<p>Drive attached to the any of the analyzer's USB ports.</p> <p>In order for the R8200 to recognize an attached thumb drive, security features such as password protection or encryption must be disabled. Details of the firmware update process are not included in this manual since they tend to evolve with analyzer development. The latest and correct update procedure is provided with each firmware revision made available.</p>
--	---

Options (Settings submenu)

The Options menu is used to view the R8200's enabled options and to activate additional options.

Notes	These include enhanced features for the main R8200 system along with additional radio communication protocols or special test functions.
-------	--

Enter Option Key (Options submenu)

Provides a means for entering a unit-specific 16-digit number key to enable additional options purchased after the original order.

Discrete Values	0 to 9, A to Z, ., *, #
Saved State	Saved with instrument state

Glossary

+

+/-

Plus or minus

A

A

Ampere

AC

Alternating Current

ACELP

Algebraic Code-Excited Linear Prediction

AM

Amplitude Modulation

AMBE

DVSI Advanced Multi-Band Excitation

APCO

Association of Public-Safety Communications Officials

APIPA

Automatic Private IP Addressing

AUTO

Automatic

B

BER

Bit Error Rate

BIOS

Basic Input/Output System

BNC

Coaxial RF Connector

bps

Bits Per Second

BW

Bandwidth

C

C

Celsius

C4FM

Continuous 4 Level FM

CAI

Common Air Interface

CCIR

International Radio Consultative Committee

CCITT

International Telegraph and Telephone Consultative Committee

Cm

Centimeters

CMOS

Complementary Metal Oxide Semiconductor

CRLF

Carriage-return-line feed

CTCSS

Continuous Tone-Coded Squelch System

CW

Continuous Wave

D**dB**

Decibel

dBc

Decibel (referred to carrier)

dBm

Decibel (referred to 1 mW into 50 Ω)

DC

Direct Current

Demod

Demodulation

DHCP

Dynamic Host Configuration Protocol

Div

Division

DMO

TETRA Direct Mode Operation (inter-radio)

DMR

ETSI Digital Mobile Radio

DNS

Domain Name System/Server

DPL

Digital Private Line, a Motorola registered trademark

DQPSK

Differential Quadrature Phase-Shift Keying

DTMF

Dual-tone multi-frequency

DVM

Digital Voltmeter

E**e.g.**

example given; for example

EEA

Electronic Engineering Association

EIA

Electronics Industry Association

ETSI

European Telecommunications Standards Institute

F**FFT**

Fast Fourier Transform

FM

Frequency Modulation

FREQ

Frequency

FSK

Frequency Shift Keying

FTP

File Transfer Protocol

G**GHz**

Gigahertz

H**HPF**

High Pass Filter

HTTP

Hyper-Text Transfer Protocol

Hz

Hertz

I**i.e.**

that is to say; in other words

I/O

Input and/or Output

IC

Integrated Circuit

ICMP

Internet Control Message Protocol

ID

Identification

IEEE

Institute of Electrical and Electronics Engineers

IF

Intermediate Frequency

inbound

Tx from mobile into base station

IP

Internet Protocol

ISI

Inter-Symbol Interference

K**kHz**

Kilohertz

Kohm

Kilo Ohm

L**LC**

Link Control

LCD

Liquid Crystal Display

LED

Light-Emitting Diode

LPF

Low Pass Filter

Lvl

Level

**MAC**

Media Access Control

MAX

Maximum

MB

Megabytes

MHz

Megahertz

MIC

Microphone

MIN

Minimum

MNI

TETRA Mobile Network Identity

ms

Millisecond

MSB

Most Significant Bit

mV

Millivolt

mW

Milliwatt

**n**

Number

N/A

Not Applicable

NAC

Network Access Code

NaN

Not a Number

NI

National Instruments Corporation

NVM

Non-volatile memory

**0.153**

ITU O series recommendation

opcode

Operation Code

outbound

Tx out of base to mobile station

**P25**

Project 25

PC

Personal Computer

PCT

Percent

PL

Private Line, a Motorola registered trademark

Q**QAM**

Quadrature Amplitude Modulation

R**RAN**

Radio Access Number

RBW

Resolution Bandwidth

RDCH

RF Direct Traffic Channel

REF

Reference

RF

Radio Frequency

RMS

Root-Mean-Square

RS

Receiver Specification

RSS

Radio Service Software

RTCH

RF Traffic Channel

S**S/N**

Signal to Noise

SACCH

Slow Associated Control Channel

SEC

Second

SEQ

Sequence

SINAD

Ratio of (Signal + Noise + Distortion) / (Noise + Distortion)

SSB

Single Sideband

SSI

TETRA Short Subscriber Identity

STD

Standard

SW

Switch

Synth

Synthesizer

T

TCP

Transmission Control Protocol

TDMA

Time Division Multiple Access

TETRA

ETSI TERrestrial Trunked RAdio

TIA

Telecommunications Industry Association

TMO

TETRA Trunked Mode Operation

TSBK

Trunking Signaling Block-Data Unit

TSI

TETRA Subscriber Identity (MNI+SSI)

TX

Transmitter

U

UHF

Ultra High Frequency

us

Microsecond

USB

Universal Serial Bus

uV

Microvolt

V

v

Volts

VAC

Volts Alternating Current

VDC

Volts Direct Current

VGA

Video Graphics Array

vocoder

voice encoder / decoder

VRMS

Volts (root-mean-square)

vs.

versus

W

W

Watts

Z

ZVEI

Zentral-Verband der Elektro-Industrie (a German Electronics Industry Association)